



SILICON LABS 20TH ANNIVERSARY
2016 Annual Report

20

To Our Shareholders

In 2016, we celebrated our 20th anniversary. Over the past two decades, we have applied our mixed-signal and RF design expertise to deliver industry-leading solutions across a diverse set of markets and applications. From our groundbreaking DAAs for global modems, to the world's first CMOS RF synthesizers for mobile communications, breakthrough radio and TV tuner technology, advanced timing solutions for high-speed communications, digital isolators for power systems, and microcontrollers and wireless SoCs for the Internet of Things (IoT), we have consistently demonstrated our ability to pioneer innovation and achieve market leadership.

Our revenue growth rate accelerated in 2016, with the business mix shifting favorably to faster growing IoT and Infrastructure products, which now represent nearly two-thirds of total revenue. In the second half, this favorable mix further enabled target model performance in top-line growth, gross margin and operating margin. For the year, we delivered record revenue of \$698 million, outperforming the industry with annual growth of eight percent.

Conservative financial management and operational excellence have guided Silicon Labs' success. For the year we delivered gross margins of 60.8 percent, at the upper-end of our target model range. Operating expenses increased four percent, reflecting continued investment in R&D. We posted a notable improvement in profitability, with non-GAAP operating margin increasing more than 200 basis points from 2015 to 19 percent. Non-GAAP diluted earnings per share grew 24 percent. Operating cash flows of \$129 million, were up 22 percent over 2015. Strong cash generation enabled the company to repurchase \$41 million worth of shares, and end the year with \$300 million in cash, cash equivalents and investments.

The rapid deployment of the IoT throughout society and the global economy now represents Silicon Labs' largest and fastest growing market opportunity, with our IoT products approaching half of total revenues and achieving growth of 20 percent in 2016.

Over the last decade, we've applied more than two thousand man-years of engineering effort and innovation to build our IoT portfolio of energy-friendly microcontrollers, multiprotocol wireless system-on-chip ICs and modules, connectivity software, and development tools targeting power-sensitive, size- and cost-constrained end-node applications.

As the IoT proliferates across an increasing range of applications and customers, it presents a sustainable, long-term growth path, where we look to drive integration and functionality, optimize costs, deliver comprehensive hardware and software solutions, expand our multiprotocol capabilities to a wider array of wireless connectivity options, and create new opportunities for differentiation.

In October, we acquired Micrium, the leading provider of real-time operating system (RTOS) software for embedded computing. Combining the capabilities of an RTOS with our silicon and software solutions serves as a unique differentiator and further solidifies Silicon Labs' position as the leading IoT

solutions provider as we integrate higher levels of functionality into our offerings and extend our leadership in the growing IoT markets in 2017 and beyond.

In Infrastructure, timing and isolation products achieved record revenue, with 17 percent annual growth. Timing products benefitted from a number of megatrends, including the shift from enterprise to cloud computing in data centers, increasing demand for bandwidth, a shift in capex from wireless to wireline, and 100G adoption in data center interconnect and metro area networks. Isolation products have delivered eight consecutive quarters of growth as we replace legacy optocouplers and take share from competitors in a variety of applications, including highly efficient power supplies, electric and hybrid electric vehicles, advanced motor controls and solar inverters.

Broadcast products exceeded expectations, declining two percent for the year. Our global TV Tuner market share increased to more than 60 percent, with lower ASPs driving a net decline in our Broadcast consumer products, offset by growth in Broadcast automotive.

We are beginning a new chapter in the creation of a more connected world, where the intersection of cloud computing and the proliferation of connected devices will transform our lives and economy in dramatic ways, and Silicon Labs is at the heart of it. We are increasing shareholder value by targeting large, high-quality, and growing markets, maintaining gross margins, and managing opex, resulting in leverage to the bottom line. We are executing on this strategy, and have never been more excited about our position to capitalize on the opportunities that lie ahead.

We appreciate your investment in Silicon Labs.



Tyson Tuttle

President and Chief
Executive Officer

Handwritten signature of Tyson Tuttle in black ink.

Nav Sooch

Chairman

Handwritten signature of Nav Sooch in black ink.

Non-GAAP Financials*

In thousands, except per share data

	Q1 2016	Q2 2016	Q3 2016	Q4 2016	FY2016
Revenue	\$162,025	\$174,908	\$178,083	\$182,610	\$697,626
% YOY Growth	-1.0%	6.1%	14.0%	14.1%	8.2%
Gross Margin	\$96,613	\$108,952	\$108,605	\$109,740	\$423,910
% of Revenue	59.6%	62.3%	61.0%	60.1%	60.8%
R&D	\$38,520	\$40,578	\$39,600	\$41,378	\$160,076
% of Revenue	23.8%	23.2%	22.2%	22.7%	22.9%
SG&A	\$32,970	\$32,519	\$31,408	\$31,792	\$128,689
% of Revenue	20.3%	18.6%	17.7%	17.4%	18.5%
Operating Expenses	\$71,490	\$73,097	\$71,008	\$73,170	\$288,765
% of Revenue	44.1%	41.8%	39.9%	40.1%	41.4%
Operating Income	\$25,123	\$35,855	\$37,597	\$36,570	\$135,145
% of Revenue	15.5%	20.5%	21.1%	20.0%	19.4%
Net Income	\$21,465	\$31,754	\$32,416	\$32,011	\$117,646
% of Revenue	13.2%	18.2%	18.2%	17.5%	16.9%
Diluted Earnings Per Share	\$0.51	\$0.75	\$0.77	\$0.75	\$2.78

*Please see the supplemental tables provided in this report for a reconciliation of GAAP to non-GAAP results in Appendix I. Past performance does not guarantee future results. This Annual Report to Shareholders contains forward-looking statements, and actual results could differ materially. Risk factors that could cause actual results to differ are set forth in the "Risk Factors" section and throughout our 2016 Form 10-K, which is included in this Annual Report.

Revenue

In millions

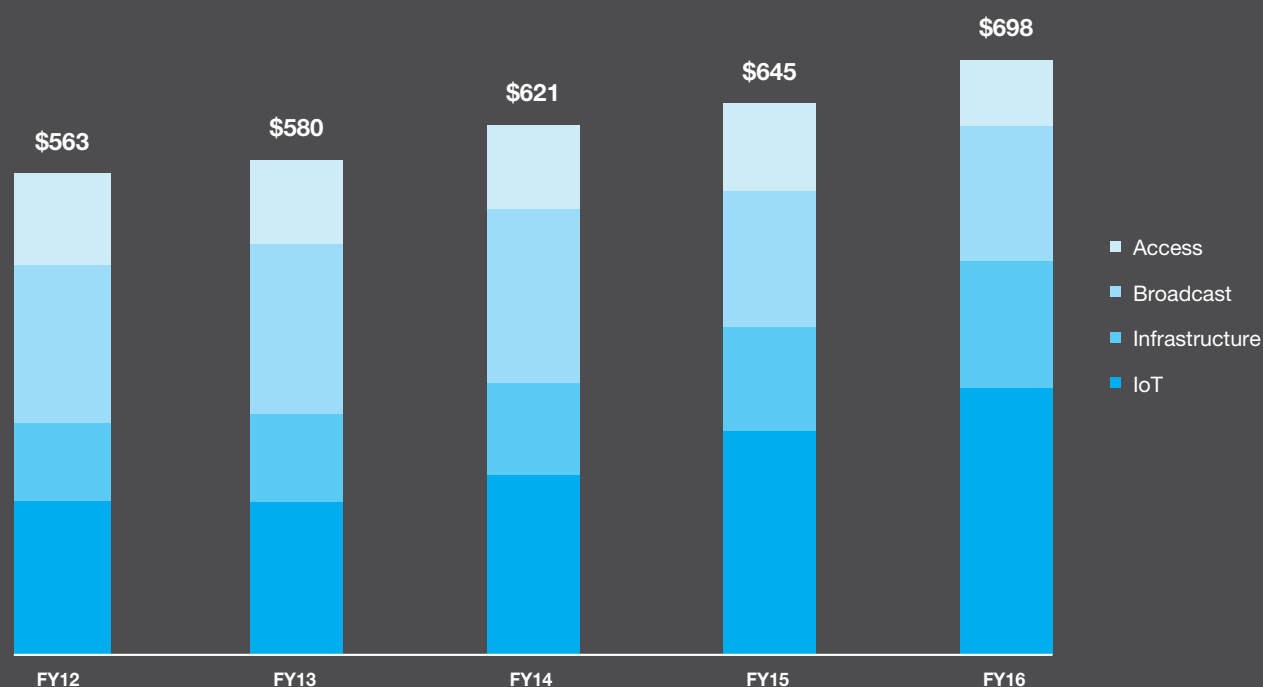

From startup to IPO.

2016 marks Silicon Labs' 20th anniversary. Since inception, we've grown from a small semiconductor startup to a global supplier of silicon, software and solutions for a more connected world. We have a long history of leveraging our mixed-signal and RF design expertise to deliver highly integrated solutions and consistently demonstrate our ability to pioneer innovation and achieve market leadership.

1996 Our story begins in 1996 in Austin, Texas, with three engineers and a passion for mixed-signal design.

Nav Sooch and Jeff Scott, who met while working at AT&T Bell Labs, strike a bond with Dave Welland during their time at Crystal Semiconductor. Based on mutual respect for one another's talents, they become friends, and begin thinking about starting their own business.

At an after-work happy hour, they discuss the pros and cons of starting their own company. Dave suggests they toss a coin—heads they strike out on their own, tails they don't. Heads it is, and Silicon Labs is born. When asked what they would've done if it came up tails, they said, "We would've gone two out of three."





Driving innovation through integration is in our DNA.

By leveraging our superior mixed-signal design expertise, we developed the industry's most elegant and efficient Digital Access Arrangement (DAA) for computer modems, integrating multiple components and reducing system cost and complexity.

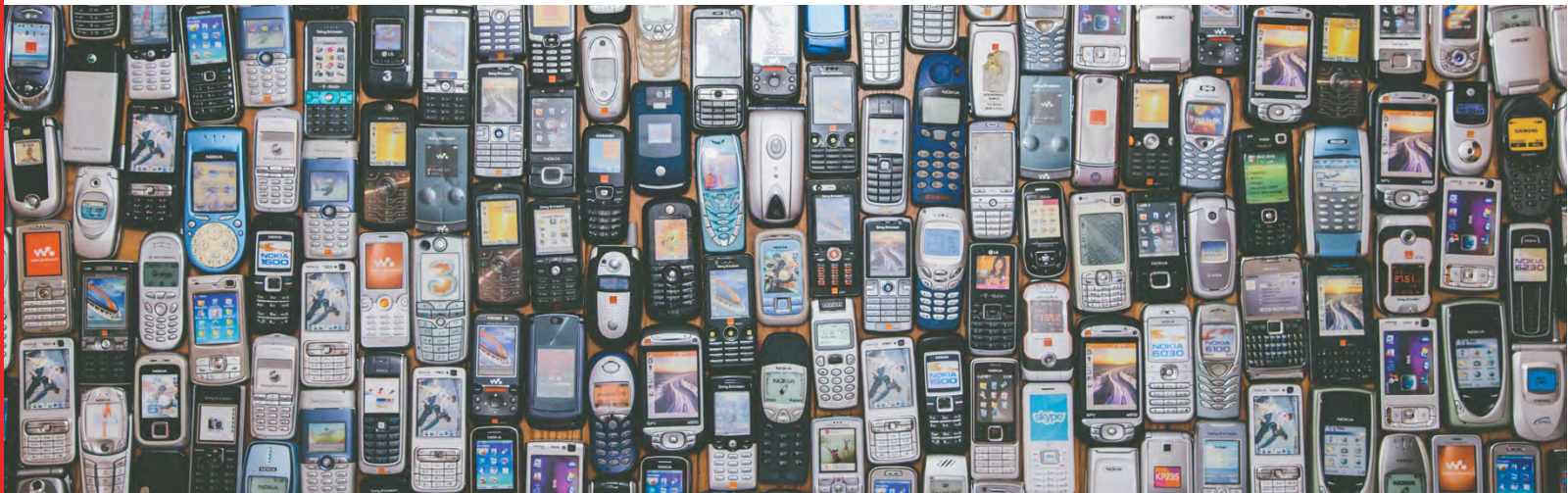
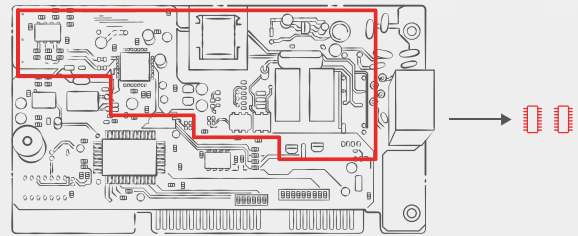

1997 \$5 million in first round funding is secured from Austin Ventures and angel investors.

1998 Our DAA replaces a bulky mess of components with more elegant and efficient ICs.

Our solution allows a single modem to work worldwide, costs half as much as competitors' products, and uses one-fifth the circuit board space. Twenty years later, we're still selling IC products based on our DAA technology and innovating breakthrough products.

The RF synthesizer helps mobile phones go mainstream.

Our core design team creates the world's first CMOS radio frequency (RF) synthesizer for cell phones. We realize that redesigning the RF in CMOS can make mobile phones easier and less expensive to produce. By squeezing nearly 80 components onto a single chip, handset makers are able to save valuable space. Our integration expertise remains a key differentiator today.



2000 We kick off the new millennium poised for growth.

In March 2000, we raise \$91 million with an initial public offering—listed on the NASDAQ® as SLAB.

Expanding into new markets.

As technology and connectivity pervade every aspect of our lives, demand increases exponentially for mixed-signal ICs that connect the analog world we live in to the digital world of computing.

2003 Entering a multi-billion-dollar market with hardworking 8-bit MCUs.

Our acquisition of Cygnal Integrated Products significantly strengthens our participation in channel sales and opens the door to the multi-billion-dollar 8-bit MCU market, making it possible for us to provide customers with design flexibility, improved time-to-market, and superior system performance.

2004 Shipping more than 70 types of 8-bit MCUs based on the proven 8051 architecture.

2005 Turning up the volume with our single-chip FM tuner.

Our FM tuner product launch enables customers to easily add FM radio functionality to handsets. This single-chip solution is such a success that it becomes the fastest-ramping product in our history.



2006

Bringing innovation to leading-edge industrial automation and power systems.

Industrial environments require solutions that deliver on safety, performance, and robustness. We introduce innovative mixed-signal IC solutions for digital isolation and power products, including CMOS digital isolators, isolated gate drivers, isolated current sensors, isolated system products, and Power over Ethernet (PoE) controllers.

2007

Hanging up on the handset market expands opportunities.

We decide to sell our cellular RF and baseband business and focus on our core expertise of designing highly differentiated mixed-signal CMOS ICs. By concentrating on our strengths and aligning our products to market needs, we find new applications for our wireless capabilities.

Increasing performance while eliminating more than 100 components is our next blockbuster.

Performance, size, and cost savings allow manufacturers to create new ultra-thin form factors without compromising picture quality.

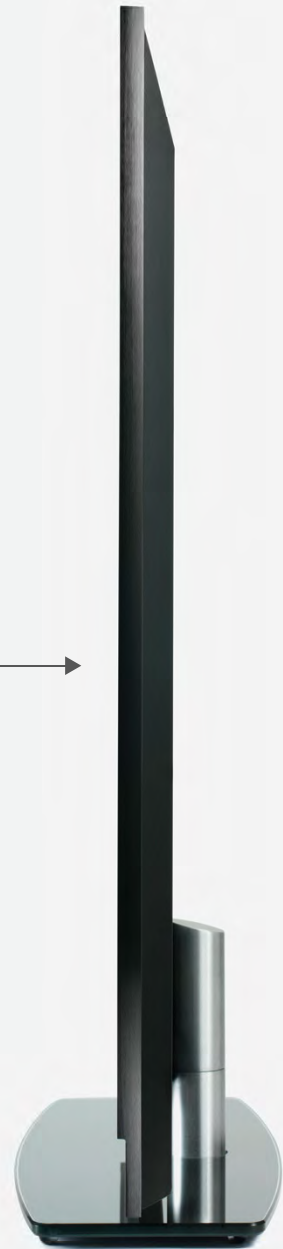
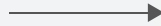
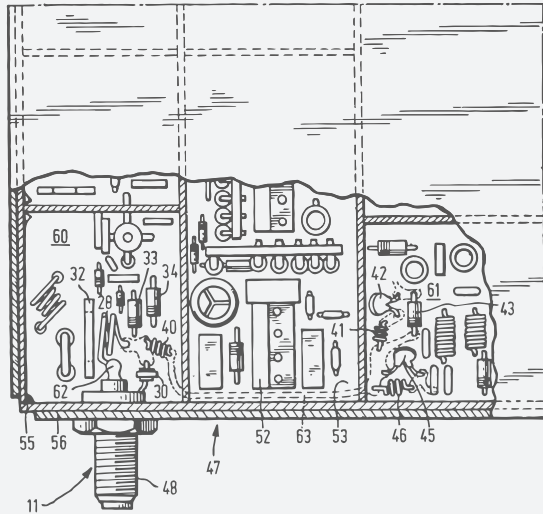

2009

Our Si2170 debuts as the first single-chip hybrid TV tuner, delivering improved performance, size, and cost compared to traditional TV tuner solutions.

By eliminating more than 100 discrete components while enabling TV makers to improve picture quality and reception for both analog and digital broadcasts, our tuners achieve what our competitors have been trying to accomplish for more than a decade.

2010

Secure design wins with five of the top six integrated digital TV brands.

Today, we ship to nine of the top 10 TV OEMs and enjoy more than 60 percent of the worldwide flat panel TV market share.



2010 Timing emerges as a key product area as we increase our penetration with leading communications equipment providers.

We introduce a series of breakthrough products, including programmable oscillators and an entire family of frequency-flexible clocks and buffers that reduce our customers' lead times and provide improved reliability, energy efficiency, and performance.

2011 Driving a superior in-vehicle experience.

Our automotive solutions provide industry-leading performance and features for infotainment to support worldwide broadcast radio requirements.

A woman with long dark hair, wearing a light-colored sweater and jeans, is sitting in a black office chair at a desk. She is looking at a computer monitor. The desk is cluttered with various electronic components and cables. In the background, there are large pieces of industrial equipment, possibly test chambers or synthesizers, with various pipes and cables. The setting appears to be a modern laboratory or a high-tech office. The overall lighting is bright and clean.

Building a more connected world.

“The wireless technologies we’ve pioneered since the early days of RF synthesizers and transceivers paved the way for our entry into the IoT, and our new product developments and acquisitions since 2012 have built upon this framework.”

Tyson Tuttle, CEO



Pushing limits.

Our customers are pushing the limits in IoT development, and since 1996, it's been our mission to provide the silicon, software and solutions to help them bring their designs to market faster. Because with the right building blocks, anything is possible.



Sense

Sensors are the eyes and ears of the IoT.

Heart Rate Monitoring
IR, Ambient & UV Light
Proximity & Gesture
Temperature & Humidity



Connect

We offer one of the broadest low-power connectivity portfolios in the market.

zigbee®/Thread mesh SoCs & Software
Bluetooth®, mesh & Wi-Fi® Modules
Blue Gecko Solutions
Sub-GHz transceivers & SoCs



Compute

MCUs serve as the brains in connected devices.

32-bit ARM® Cortex-M Cores
8-bit 8051 Core
Ultra-low Energy
High integration & functionality



Tools

Development tools help our customers get to market faster.

Simplicity Studio™
Micrium® Software
Starter & Development Kits
Reference Designs

2012 Acquire Ember, a leader in zigbee mesh networking.

This strategic acquisition brings the technology and software expertise required to enable the low-power mesh sensor networks being deployed today in connected home and industrial applications, and accelerates our ability to offer complete system solutions to our customers.

2013 Acquire Energy Micro, leaders in energy-efficient ARM-based 32-bit MCUs.

We share a complementary vision of a greener, smarter, wirelessly connected world, and the foundation for this combined vision is ultra-low-power technology enabled by each company's innovative mixed-signal design.

2014 Introduce Simplicity Studio.

This development ecosystem for our MCU and wireless portfolio makes the design process easier, faster, and more efficient by providing embedded designers with everything they need to complete their projects, from initial concept to final product.

Announce our founding membership in the Thread Group.

Chartered to develop a new IP-enabled, wireless mesh networking protocol, and expected to become a key open-standard supporting secure, interoperable, robust, and power-efficient connectivity across a wide range of IoT applications for the home.

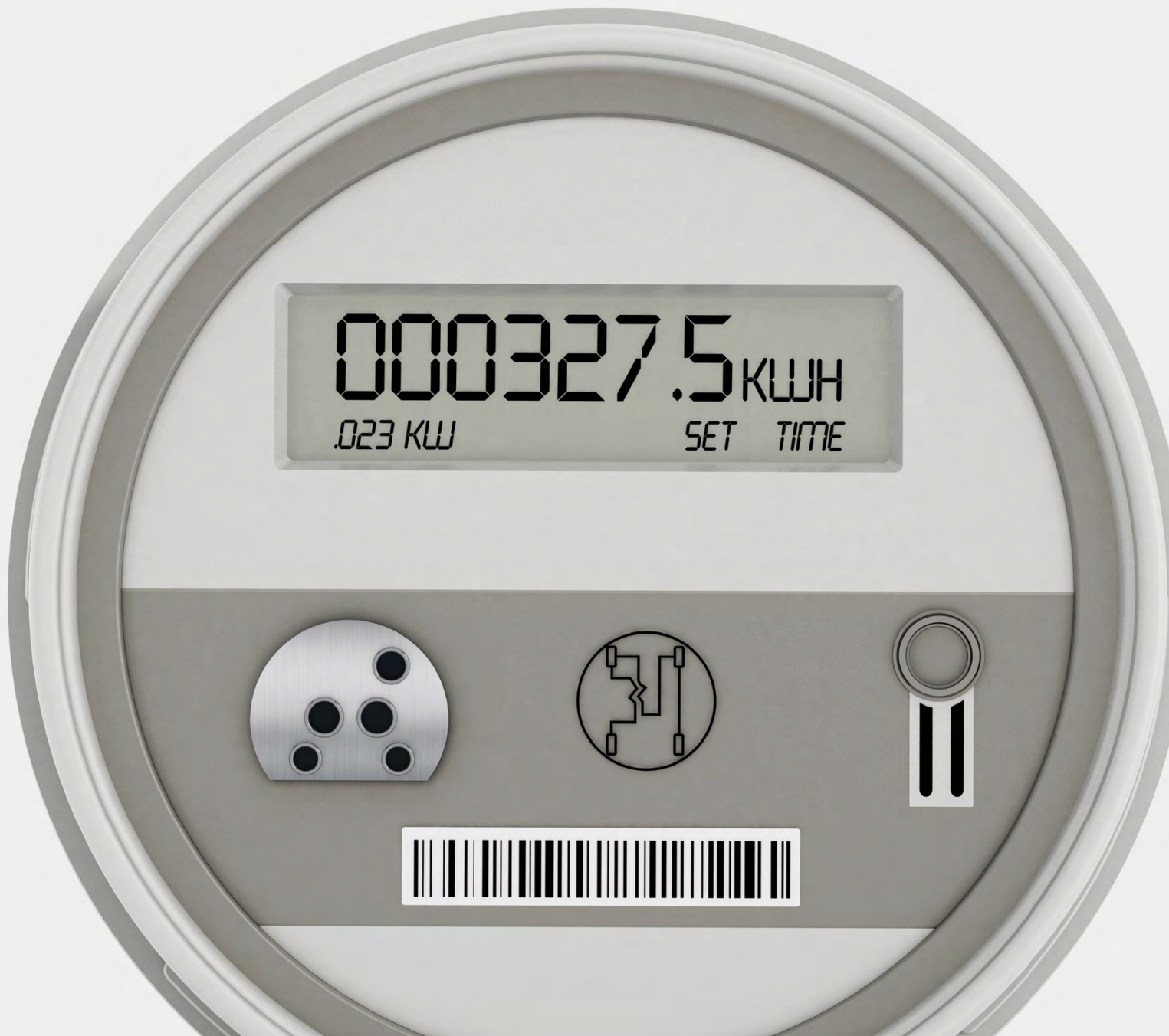

2015

Acquire module companies, Bluegiga and Telegesis.

We expand our wireless connectivity portfolio and our customer reach. Modules make it easier for our customers to reduce cost, complexity and compliance effort, while speeding time-to-market.

2016

Launch our Wireless Gecko portfolio featuring three families of multiprotocol SoCs, an industry first.

Mighty Gecko based on our Thread and zigbee software stacks; Flex Gecko for proprietary protocols, and Blue Gecko to add Bluetooth low-energy for point-to-point connectivity.

Acquire Micrium, the leading provider of real-time-operating-system (RTOS) software for embedded computing.

Combining the capabilities of an RTOS with our silicon and software solutions serves as a unique differentiator and further solidifies our position as the leading IoT solutions provider as we integrate higher levels of functionality into our offerings.

We achieve a key milestone with the shipment of 100 million mesh devices to date.

Building a more connected world—the next 20 years.

The ways in which we'll use connected devices are virtually limitless, and will fuel the growth of the IoT and the opportunities it presents. More devices mean more data, driving an explosion in demand for bandwidth and storage. Through flexible, scalable network and data center solutions, we're strengthening the backbone of the IoT and building a strong infrastructure with tools to simplify design and improve system reliability.



**UNITED STATES
SECURITIES AND EXCHANGE COMMISSION**

Washington, D.C. 20549

FORM 10-K

(Mark One)

**ANNUAL REPORT PURSUANT TO SECTION 13 OR 15(d) OF THE
SECURITIES EXCHANGE ACT OF 1934**

For the fiscal year ended December 31, 2016

or

**TRANSITION REPORT PURSUANT TO SECTION 13 OR 15(d) OF THE
SECURITIES EXCHANGE ACT OF 1934**

For the transition period from _____ to _____

Commission file number: 000-29823

SILICON LABORATORIES INC.

(Exact name of registrant as specified in its charter)

Delaware

(State or other jurisdiction of
incorporation or organization)

400 West Cesar Chavez, Austin, Texas
(Address of principal executive offices)

74-2793174

(I.R.S. Employer
Identification No.)

78701

(Zip Code)

(512) 416-8500

(Registrant's telephone number, including area code)

Securities registered pursuant to Section 12(b) of the Act:

Title of each class	Name of exchange on which registered
Common Stock, \$0.0001 par value	The NASDAQ Stock Market LLC

Securities registered pursuant to Section 12(g) of the Act: **None**

Indicate by check mark if the registrant is a well-known seasoned issuer, as defined in Rule 405 of the Securities Act. Yes No

Indicate by check mark if the registrant is not required to file reports pursuant to Section 13 or Section 15(d) of the Act. Yes No

Indicate by check mark whether the registrant (1) has filed all reports required to be filed by Sections 13 or 15(d) of the Securities Exchange Act of 1934 during the preceding 12 months (or for such shorter period that the registrant was required to file such reports), and (2) has been subject to such filing requirements for the past 90 days. Yes No

Indicate by check mark whether the registrant has submitted electronically and posted on its corporate Website, if any, every Interactive Data File required to be submitted and posted pursuant to Rule 405 of Regulation S-T (§232.405 of this chapter) during the preceding 12 months (or for such shorter period that the registrant was required to submit and post such files). Yes No

Indicate by check mark if disclosure of delinquent filers pursuant to Item 405 of Regulation S-K (§229.405 of this chapter) is not contained herein, and will not be contained, to the best of the registrant's knowledge, in definitive proxy or information statements incorporated by reference in Part III of this Form 10-K or any amendment to this Form 10-K.

Indicate by check mark whether the registrant is a large accelerated filer, an accelerated filer, a non-accelerated filer, or a smaller reporting company. See the definitions of "large accelerated filer," "accelerated filer" and "smaller reporting company" in Rule 12b-2 of the Exchange Act.

Large accelerated filer Accelerated filer Non-accelerated filer Smaller reporting company

Indicate by check mark whether the registrant is a shell company (as defined in Rule 12b-2 of the Exchange Act). Yes No

The aggregate market value of the voting and non-voting common equity held by non-affiliates computed by reference to the price at which the common equity was last sold as of the last business day of the registrant's most recently completed second fiscal quarter (July 1, 2016) was \$1,951,606,092 (assuming, for this purpose, that only directors and officers are deemed affiliates).

There were 41,890,791 shares of the registrant's common stock issued and outstanding as of January 23, 2017.

DOCUMENTS INCORPORATED BY REFERENCE

Portions of the Proxy Statement for the registrant's 2016 Annual Meeting of Stockholders are incorporated by reference into Part III of this Form 10-K.

(This page has been left blank intentionally.)

Table of Contents

	<u>Page Number</u>
<i>Part I</i>	
Item 1. Business	2
Item 1A. Risk Factors	13
Item 1B. Unresolved Staff Comments	27
Item 2. Properties	28
Item 3. Legal Proceedings	28
Item 4. Mine Safety Disclosures	29
<i>Part II</i>	
Item 5. Market for Registrant’s Common Equity, Related Stockholder Matters and Issuer Purchases of Equity Securities	30
Item 6. Selected Financial Data	32
Item 7. Management’s Discussion and Analysis of Financial Condition and Results of Operations	33
Item 7A. Quantitative and Qualitative Disclosures about Market Risk	47
Item 8. Financial Statements and Supplementary Data	48
Item 9. Changes in and Disagreements with Accountants on Accounting and Financial Disclosure	48
Item 9A. Controls and Procedures	48
Item 9B. Other Information	49
<i>Part III</i>	
Item 10. Directors, Executive Officers and Corporate Governance	50
Item 11. Executive Compensation	50
Item 12. Security Ownership of Certain Beneficial Owners and Management and Related Stockholder Matters	50
Item 13. Certain Relationships and Related Transactions, and Director Independence	50
Item 14. Principal Accounting Fees and Services	50
<i>Part IV</i>	
Item 15. Exhibits and Financial Statement Schedules	51

Cautionary Statement

Except for the historical financial information contained herein, the matters discussed in this report on Form 10-K (as well as documents incorporated herein by reference) may be considered “forward-looking” statements within the meaning of Section 27A of the Securities Act of 1933, as amended, and Section 21E of the Securities Exchange Act of 1934, as amended. Such forward-looking statements include declarations regarding the intent, belief or current expectations of Silicon Laboratories Inc. and its management and may be signified by the words “believe,” “estimate,” “expect,” “intend,” “anticipate,” “plan,” “project,” “will” or similar language. You are cautioned that any such forward-looking statements are not guarantees of future performance and involve a number of risks and uncertainties. Actual results could differ materially from those indicated by such forward-looking statements. Factors that could cause or contribute to such differences include those discussed under “Risk Factors” and elsewhere in this report. Silicon Laboratories disclaims any intention or obligation to update or revise any forward-looking statements, whether as a result of new information, future events or otherwise.

Part I

Item 1. Business

General

Silicon Laboratories Inc. is a provider of silicon, software and solutions for the Internet of Things (IoT), Internet infrastructure, industrial, consumer and automotive markets. We solve some of the electronics industry's toughest problems, providing customers with significant advantages in performance, energy savings, connectivity and design simplicity. Backed by our world-class engineering teams with strong software and mixed-signal design expertise, Silicon Laboratories empowers developers with the tools and technologies they need to advance quickly and easily from initial idea to final product.

Mixed-signal integrated circuits (ICs) are electronic components that convert real-world analog signals, such as sound and radio waves, into digital signals that electronic products can process. Therefore, mixed-signal ICs are critical components in products addressing a variety of markets, including industrial, communications, consumer and automotive. Our world-class, mixed-signal ICs leverage standard complementary metal oxide semiconductor (CMOS), a low cost, widely available process technology. This enables smaller, more cost effective and energy efficient solutions. Our expertise in analog-intensive, mixed-signal IC design in CMOS allows us to develop new and innovative products that are highly integrated, simplifying our customers' designs and improving their time-to-market.

Industry Background

The pervasiveness of connectivity and the explosion in mobile computing is driving semiconductor consumption. Intelligence is being added to electronic systems to enable remote monitoring, power efficiency and an improved user experience. This in turn is increasing the demand for bandwidth, requiring more infrastructure to support higher performance networks. The nearly ubiquitous availability of Internet access and the increasing intelligence of electronic devices and mobility are enabling what is called the Internet of Things, a term that describes the exponential increase in IP-enabled devices connected to the Internet.

These trends require more and more interaction between the analog world we live in and the digital world of computing, and therefore require analog-intensive, mixed-signal circuits. Traditional mixed-signal designs relied upon solutions built with numerous, complex discrete analog and digital components. While these traditional designs provide the required functionality, they are often inefficient and inadequate for use in markets where size, cost, power consumption and performance are increasingly important product differentiators. In order to improve their competitive position, electronics manufacturers need to reduce the cost and complexity of their systems and enable new features or functionality to differentiate themselves from their competitors.

Simultaneously, these manufacturers face accelerating time-to-market demands and must be able to rapidly adapt to evolving industry standards and new technologies. Because analog-intensive, mixed-signal design expertise is difficult to find, these manufacturers increasingly are turning to third parties, like us, to provide advanced mixed-signal solutions. Mixed-signal design requires specific expertise and relies on creative, experienced engineers to deliver solutions that optimize speed, power and performance, despite the noisy digital environment, and within the constraints of standard manufacturing processes. The development of this design expertise typically requires years of practical analog design experience under the guidance of a senior engineer, and engineers with the required level of skill and expertise are in short supply.

Many IC solution providers lack sufficient analog expertise to develop compelling mixed-signal products. As a result, manufacturers of electronic devices value providers that can supply them with

mixed-signal solutions with greater functionality, smaller size and lower power requirements at a reduced cost and shorter time-to-market.

Products

We provide analog-intensive, mixed-signal solutions for use in a variety of electronic products in a broad range of applications for the IoT market including connected home, smart lighting, security, wearables and smart energy applications. We are a supplier of wireless connectivity solutions for the IoT based on Bluetooth®, zigbee®, Thread, Wi-Fi® and sub-GHz technologies.

We provide a wide range of timing and isolation products for infrastructure applications including high-performance clocks and oscillators for networking equipment, data centers and wireless base stations, as well as digital isolators and current sensors for industrial power supplies, motor control, solar inverters and hybrid-electric vehicles. We also provide broadcast products, such as TV tuners and demodulators and automotive radio tuners, and access products including subscriber line interface circuits for voice over IP (VoIP), embedded modems, and Power over Ethernet (PoE) power source equipment and powered device ICs.

Our products integrate complex mixed-signal functions that are frequently performed by numerous discrete components in competing products into a single chip or chipset. By doing so, we are able to create products that, when compared to many competing products:

- Require less printed circuit board (PCB) space;
- Reduce the use of external components lowering the system cost and simplifying design;
- Offer superior performance improving our customers' end products;
- Provide increased reliability and manufacturability, improving customer yields; and/or
- Reduce system power requirements enabling smaller form factors and/or longer battery life.

We group our products into the following categories:

- Internet of Things products, which include our microcontroller (MCU), wireless, sensor and analog products;
- Broadcast products, which include our broadcast consumer and automotive products;
- Infrastructure products, which include our timing products (clocks and oscillators), and isolation devices; and
- Access products, which include our VoIP products, embedded modems and our PoE devices.

The following table summarizes the diverse product areas and applications for the various products that we have introduced to customers:

Product Areas and Description

Applications

Internet of Things Products

Microcontrollers and Wireless Products

We offer a family of products ideal for embedded systems that include energy friendly 8-bit mixed-signal microcontrollers, 32-bit wireless MCUs and ultra low-power 32-bit MCUs based on scalable ARM® Cortex-M0+/M3/M4 cores, as well as wireless connectivity devices such as our EZRadio® family of fully integrated, low power transceivers. Our wireless modules provide flexible, highly integrated products that meet demanding requirements and can be used in a number of applications. Our wireless connectivity solutions for the IoT are based on Bluetooth, zigbee, Thread, Wi-Fi and sub-GHz technologies. Our EFM32™, EFM8™, 8051, wireless MCUs and wireless SoCs are supported by Simplicity Studio™, a one-click access to design tools, documentation, software and support resources. These products generally integrate intelligent data capture, high performance processing, and communication interfaces in a single system on a chip. We also offer a real-time operating system (RTOS) to help simplify software development for IoT applications by coordinating and prioritizing multiprotocol connectivity, SoC peripherals and other system-level activities. This family of products addresses a variety of end-markets, including the IoT (connected home, smart lighting, security, wearables and smart energy applications), automotive, communications, consumer, industrial, medical and power management markets.

- Home automation
- Security systems
- Smart lighting
- Smart metering
- Wearables
- Industrial automation and control
- Consumer electronics
- Medical instrumentation
- Automotive sensors and controls
- Electronic test and measurement equipment
- White goods
- Remote controls

Sensors

Our sensor products include optical sensors (proximity, ambient light gestures and heart rate), as well as relative humidity (RH) / temperature sensors. These devices leverage our mixed-signal capability to provide high accuracy, process technology to improve performance and lower power consumption than competing parts.

- Consumer health & fitness (wearables)
- Smart home sensing
- Industrial controls
- Toys and consumer electronics
- Monitors and lavatory controls
- Consumer medical

Product Areas and Description

Broadcast Products

Broadcast Consumer

Our worldwide hybrid TV tuners with analog TV demodulator in a single CMOS IC leverage our proven digital low-IF architecture and exceed the performance of traditional discrete TV tuners, enabling TV makers to deliver improved picture quality and better reception for both analog and digital broadcasts. Our small, low power and high performance single and dual digital video demodulators support DVB-T/T2, DVB-S/S2/S2X, DVB-C/C2, and/or ISDB-T in a single chip and are ideal for equipment receiving digital terrestrial, satellite and/or cable services. Our AM/FM, HD Radio™ and DAB/DAB+ receivers deliver a complete radio solution from antenna input to audio output in a single chip. The broadcast audio products are based on an innovative digital architecture that enables significant improvements in performance, which translates to a better consumer experience, while reducing system cost and board space for our customers.

Broadcast Automotive

Our high-performance solutions for car sound systems include high fidelity radio ICs that improve the end user experience, reduce system cost and offer the latest digital radio technologies like DAB/DAB+ and HD Radio. Our scalable architecture enables infotainment system suppliers to leverage their investments across multiple product lines ranging from entry-level car radios to cutting-edge multi-tuner, multi-antenna radios for premium vehicles.

Infrastructure Products

Timing Devices

Robust demand for bandwidth is driving the deployment of next-generation Internet infrastructure equipment to deliver higher speed, higher capacity and more flexible networks. This transition puts unique requirements on the clocks and oscillators used to provide timing and synchronization for the equipment responsible for switching, transporting, processing and storing network traffic. To meet this need, we provide low jitter, frequency flexible, mass customizable timing solutions that accelerate development time, minimize cost and improve system reliability. Our high-performance “clock-tree-on-a-chip” products offer highly integrated single-chip IC solutions for clock synthesis and jitter attenuation, offering superior jitter performance and frequency flexibility for high data rate applications.

Isolation Products

Our isolation techniques enable customers to meet safety standards for isolation and solve difficult electronic noise issues. Products include multi-channel isolators, isolated drivers, isolated power converters and mixed-signal devices that simplify design, improve reliability, minimize noise emissions, and reduce system cost.

Applications

- Integrated digital televisions (iDTV)
- Free-to-Air (FtA) or pay-TV set-top boxes
- PVR/DVD/Blu-Ray/HDD video recorders
- PC-TV applications
- AM/FM clock radios
- Portable audio devices
- MP3/digital media players
- Home theater systems
- DAB digital radios
- HD Radio digital radios

- Automotive infotainment systems/radios
- Navigation/GPS devices

- Optical networking
- Networking equipment
- Telecommunications
- Broadcast video
- Servers and storage
- Wireless backhaul
- Wireless base stations
- Small cells
- Test and measurement equipment
- Image processing
- High-speed data acquisition

- Switch mode power supplies
- Industrial networking
- Hybrid / Electric automotive drive trains
- Solar inverters
- Motor control
- Isolated analog data acquisition

Product Areas and Description

Applications

Access Products

ProSLIC® Subscriber Line Interface Circuits for VoIP

Our ProSLIC provides the analog subscriber line interface on the source end of the telephone which generates dial tone, busy tone, caller ID and ring signal. Our offerings are well suited for the market for Voice over IP telephony applications deployed over cable, DSL, optical and wireless fixed terminal networks.

- Voice functionality for cable, DSL and optical digital modems and terminal adapters
- VoIP residential gateways
- Wireless local loop remote access systems
- PBXs

ISOModem® Embedded Modems

Our ISOModem embedded modems leverage innovative silicon direct access arrangement (DAA) technology and a digital signal processor to deliver a globally compliant, compact analog modem for embedded applications.

- Point of sale (POS) terminals
- Fax machines and multi-function printers
- Security systems
- Industrial monitoring
- Remote medical monitoring

Power over Ethernet

Our Power over Ethernet power source equipment and powered device ICs offer highly differentiated solutions with a reduced total bill of materials (BOM) and improved performance and reliability. Our solutions offer a higher level of integration not available with competing solutions.

- Enterprise networking routers and switches
- Wireless access points (WAP)
- VoIP phones
- POS terminals
- Security cameras

Revenues during fiscal 2016, 2015 and 2014 were generated predominately by sales of our mixed-signal products. The following summarizes our revenue by product category (in thousands):

	Fiscal Year		
	2016	2015	2014
Internet of Things	\$314,614	\$262,329	\$209,005
Broadcast	157,746	161,787	204,256
Infrastructure	147,677	121,974	108,123
Access	77,589	98,736	99,320
Revenues	<u>\$697,626</u>	<u>\$644,826</u>	<u>\$620,704</u>

Customers, Sales and Marketing

We market our products through our direct sales force and through a network of independent sales representatives and distributors. Direct and distributor customers buy on an individual purchase order basis, rather than pursuant to long-term agreements.

We consider our customer to be the end customer purchasing either directly from a distributor, a contract manufacturer or us. An end customer purchasing through a contract manufacturer typically instructs such contract manufacturer to obtain our products and incorporate such products with other components for sale by such contract manufacturer to the end customer. Although we actually sell the products to, and are paid by, the distributors and contract manufacturers, we refer to such end customer as our customer. Three of our distributors who sell to our customers, Edom Technology, Avnet and Arrow Electronics, each represented 17%, 13% and 11% of our revenues during fiscal 2016, respectively. No other distributor accounted for 10% or more of revenues for fiscal 2016.

During fiscal 2016, our ten largest end customers accounted for 25% of our revenues. We had no customer that represented more than 10% of our revenues during this period.

We maintain numerous sales offices in Asia, the Americas and Europe. Revenue is attributed to a geographic area based on the shipped-to location. The percentage of our revenues derived from outside of the United States was 86% in fiscal 2016. For further information regarding our revenues and long-lived assets by geographic area, see Note 17, *Segment Information*, to the Consolidated Financial Statements.

Our direct sales force is comprised of a number of sales professionals who possess varied levels of responsibility and experience, including directors, country managers, regional sales managers, district sales managers, strategic account managers, field sales engineers and sales representatives. We also utilize independent sales representatives and distributors to generate sales of our products. We have relationships with many independent sales representatives and distributors worldwide whom we have selected based on their understanding of the mixed-signal marketplace and their ability to provide effective field sales applications support for our products.

Our marketing efforts are targeted at both identified industry leaders and emerging market participants. Direct marketing activities are supplemented by a focused marketing communications effort that seeks to raise awareness of our company and products. Our public relations efforts are focused on leading trade and business publications. Our external website is used to deliver corporate and product information. We also pursue targeted advertising in key trade publications and we have a cooperative marketing program that allows our distributors and representatives to promote our products to their local markets in conjunction with their own advertising activities. Finally, we maintain a presence at strategic trade shows and industry events. These activities, in combination with direct sales activities, help drive demand for our products.

Due to the complex and innovative nature of our products, we employ experienced applications engineers who work closely with customers and distributors to support the design-win process, and can significantly accelerate the customer's time to market. A design-win occurs when a customer has designed our ICs into its product architecture and ordered product from us. A considerable amount of effort to assist the customer in incorporating our ICs into its products is typically required prior to any sale. In many cases, our innovative ICs require significantly different implementations than existing approaches and, therefore, successful implementations may require extensive communication with potential customers. The amount of time required to achieve a design-win can vary substantially depending on a customer's development cycle, which can be relatively short (such as three months) or very long (such as two years) based on a wide variety of customer factors. Not all design wins ultimately result in revenue, or may result in less revenue than expected. However, once a completed design architecture has been implemented and produced in high volumes, our customers are reluctant to significantly alter their designs due to this extensive design-win process. We believe this process, coupled with our intellectual property protection, promotes relatively longer product life cycles for our products and high barriers to entry for competitive products, even if such competing products are offered at lower prices. Our close collaboration with our customers provides us with knowledge of derivative product ideas or completely new product line offerings that may not otherwise arise in other new product discussions.

Research and Development

Through our research and development efforts, we leverage experienced analog and mixed-signal engineering talent and expertise to create new ICs that integrate functions typically performed inefficiently by multiple discrete components. This integration generally results in lower costs, smaller die sizes, lower power demands and enhanced price/performance characteristics. We attempt to reuse successful techniques for integration in new applications where similar benefits can be realized. We

believe that we have attracted many of the best engineers in our industry. We believe that reliable and precise analog and mixed-signal ICs can only be developed by teams of engineers who have significant analog experience and are familiar with the intricacies of designing these ICs for commercial volume production. The development of test methodologies is just one example of a critical activity requiring experience and know-how to enable the rapid release of a new product for commercial success. We have accumulated a vast set of trade secrets that allow us to pursue innovative approaches to mixed-signal problems that are difficult for competitors to duplicate. We highly value our engineering talent and strive to maintain a very high bar when bringing new recruits to the company.

Research and development expenses were \$199.7 million, \$188.1 million and \$173.0 million and in fiscal 2016, 2015 and 2014, respectively.

Technology

Our product development process facilitates the design of highly-innovative, analog-intensive, mixed-signal ICs. Our engineers' deep knowledge of existing and emerging standards and performance requirements helps us to assess the technical feasibility of a particular IC. We target areas where we can provide compelling product improvements. Once we have solved the primary challenges, our field application engineers continue to work closely with our customers' design teams to maintain and develop an understanding of our customers' needs, allowing us to formulate derivative products and refined features.

In providing mixed-signal ICs for our customers, we believe our key competitive advantages are:

- Analog and RF design expertise in CMOS;
- Digital signal processing, firmware and system design expertise;
- Microcontroller and system on a chip design expertise;
- Software expertise, including multiprotocol connectivity and real-time operating systems for the IoT;
- Module integration and design expertise; and
- Our broad understanding of systems technology and trends.

To fully capitalize on these advantages, we have assembled a world-class development team with exceptional analog and mixed-signal design expertise led by accomplished senior engineers.

Analog and RF Design Expertise in CMOS

We believe that our most significant core competency is world-class analog and RF design capability. Additionally, we strive to design substantially all of our ICs in standard CMOS processes. While it is often significantly more difficult to design analog ICs in CMOS, CMOS provides multiple benefits versus existing alternatives, including significantly reduced cost, reduced technology risk and greater worldwide foundry capacity. CMOS is the most commonly used process technology for manufacturing digital ICs and as a result is most likely to be used for the manufacturing of ICs with finer line geometries. These finer line geometries can enable smaller and faster ICs. By designing our ICs in CMOS, we enable our products to benefit from this trend towards finer line geometries, which allows us to integrate more digital functionality into our mixed-signal ICs.

Designing analog and mixed-signal ICs is significantly more complicated than designing standalone digital ICs. While advanced software tools exist to help automate digital IC design, there are far fewer tools for advanced analog and mixed-signal IC design. In many cases, our analog circuit design efforts begin at the fundamental transistor level. We believe that we have a demonstrated ability to design the most difficult analog and RF circuits using standard CMOS technologies.

Digital Signal Processing, Firmware and System Design Expertise

We consider the partitioning of a circuit to be a proprietary and creative design technique. Deep systems knowledge allows us to use our digital signal processing (DSP) design expertise to maximize the price/performance characteristics of both the analog and digital functions and allow our ICs to work in an optimized manner to accomplish particular tasks. Generally, we attempt to move analog functions into the digital domain as quickly as possible, creating system efficiencies without compromising performance. These patented approaches require our advanced DSP and systems expertise. We then leverage our firmware know-how to change the ‘personality’ of our devices, optimizing features and functions needed by various markets we serve. For example, our broadcast audio products use a proven digital low-IF receiver and transmitter architecture to deliver superior RF performance and interference rejection compared to traditional, analog-only approaches. Digital signal processing is utilized to optimize sound quality under varying signal conditions, enabling a better consumer experience. Firmware has enabled us to rapidly expand the portfolio to address multiple markets without substantial silicon changes, including shortwave, longwave, analog tuned, digital tuned and even high performance HD-capable automotive radios.

Microcontroller and System on a Chip Design Expertise

We have the talent and circuit integration methodologies required to combine precision analog, high-speed digital, flash memory and in-system programmability into a single, monolithic CMOS integrated circuit. Our microcontroller products are designed to capture an external analog signal, convert it to a digital signal, compute digital functions on the stream of data and then communicate the results through a standard digital interface. The ability to develop standard products with the broadest possible customer application base while being cost efficient with the silicon area of the monolithic CMOS integrated circuit requires a keen sense of customer value and engineering capabilities. Additionally, to manage the wide variety of signals on a monolithic piece of silicon including electrical noise, harmonics and other electronic distortions requires a fundamental knowledge of device physics and accumulated design expertise.

Software Expertise

Our software expertise allows us to develop products for markets where intelligent data capture, high-performance processing and communication are increasingly important product differentiators. The software we have developed to address these markets enable machine-to-machine communications, providing intelligence to electronic systems. Our products integrate high-performance, low-power wireless and microcontroller ICs with reliable and scalable software into a flexible and robust networking platform.

The demand for low-power, small-footprint wireless technology is accelerating as more and more IP-enabled end points are being connected to the Internet of Things (IoT). Our software enables a broad range of power-sensitive applications for the IoT, including smart energy, home automation, security and other connected products. We believe that the combination of our software and IC design expertise differentiates us from many of our competitors.

As the IoT continues to mature, a new class of embedded applications is emerging, presenting feature-rich and task-intensive use cases. This growing complexity is driving the need for real-time operating systems to help simplify software development for IoT applications by coordinating and prioritizing multiprotocol connectivity, SoC peripherals and other system-level activities. In addition to being able to manage numerous application tasks, an RTOS enhances scalability, and makes complex applications predictable and reliable. To address these application needs, we acquired Micrium, an embedded RTOS provider. Micrium has established itself as a reliable, high performance and trusted RTOS software platform, with an installed base that has grown to millions of devices.

Module Integration and Design Expertise

The market for wireless modules has grown as customers search for solutions that provide turnkey wireless connectivity to their products. The development of modules is difficult due to stringent requirements, including high levels of integration and programmability, performance, reliability, security and power efficiency. In addition, designs must meet numerous wireless standards deployed in various environments and serving diverse requirements.

Our combined expertise in IC design and software allows us to engineer the development of our modules to create a robust, high-performance connection in challenging wireless environments. We have developed wireless modules based on numerous wireless standards, including Bluetooth, zigbee, Thread, Wi-Fi and sub-GHz. We believe our demonstrated proficiency in the design of modules provides our customers with significant advantages.

Understanding of Systems Technology and Trends

Our focused expertise in mixed-signal ICs is the result of the breadth of engineering talent we have assembled with experience working in analog-intensive CMOS design for a wide variety of applications. This expertise, which we consider a competitive advantage, is the foundation of our in-depth understanding of the technology and trends that impact electronic systems and markets. Our expertise includes:

- Isolation, which is critical for existing and emerging industrial applications and telecom networks;
- Frequency synthesis, which is core technology for wireless and clocking applications;
- Integration, which enables the elimination of discrete components in a system; and
- Signal processing and precision analog, which forms the heart of consumer, industrial, medical and automotive electronics applications.

Our understanding of the role of analog/digital interfaces within electronic systems, standards evolution, and end market drivers enables us to identify product development opportunities and capitalize on market trends.

Manufacturing

As a fabless semiconductor company, we conduct IC design and development in our facilities and electronically transfer our proprietary IC designs to third-party semiconductor fabricators who process silicon wafers to produce the ICs that we design. Our IC designs typically use industry-standard CMOS manufacturing process technology to achieve a level of performance normally associated with more expensive special-purpose IC fabrication technology. We believe the use of CMOS technology facilitates the rapid production of our ICs within a lower cost framework. Our IC production employs submicron process geometries which are readily available from leading foundry suppliers worldwide, thus increasing the likelihood that manufacturing capacity will be available throughout our products' life cycles. We currently partner with Taiwan Semiconductor Manufacturing Co. (TSMC) or TSMC's affiliates and Semiconductor Manufacturing International Corporation (SMIC) to manufacture the majority of our semiconductor wafers. We believe that our fabless manufacturing model significantly reduces our capital requirements and allows us to focus our resources on design, development and marketing of our ICs.

Once the silicon wafers have been produced, they are shipped directly to our third-party assembly subcontractors. The assembled ICs are then moved to the final testing stage. This operation can be performed by the same contractor that assembled the IC, other third-party test subcontractors or within our internal facilities prior to shipping to our customers. During fiscal 2016, most of our units shipped

were tested by offshore third-party test subcontractors. We expect that our utilization of offshore third-party test subcontractors will remain substantial during fiscal 2017.

Backlog

We include in backlog accepted product purchase orders from customers and worldwide distributor stocking orders. We only include orders with an expected shipping date from us within six months. Product orders in our backlog are subject to changes in delivery schedules or cancellation at the option of the purchaser typically without penalty. Our backlog may fluctuate significantly depending upon customer order patterns which may, in turn, vary considerably based on rapidly changing business circumstances. Shipments to distributors are not recognized as revenue until the products are sold by the distributors. Additionally, our arrangements with distributors typically provide for price protection and stock rotation activities. Accordingly, we do not believe that our backlog at any time is necessarily representative of actual sales for any succeeding period.

Competition

The markets for semiconductors generally, and for analog and mixed-signal ICs in particular, are intensely competitive. We anticipate that the market for our products will continually evolve and will be subject to rapid technological change. We believe the principal competitive factors in our industry are:

- Product size;
- Level of integration;
- Product capabilities;
- Reliability;
- Price;
- Performance;
- Power requirement;
- Customer support;
- Reputation;
- Ability to rapidly introduce new products to market;
- Intellectual property; and
- Software.

We believe that we are competitive with respect to these factors, particularly because our ICs typically are smaller in size, are highly integrated, achieve high performance specifications at lower price points than competitive products and are manufactured in standard CMOS which generally enables us to supply them on a relatively rapid basis to customers to meet their product introduction schedules. However, disadvantages we face include our relatively short operating history in certain of our markets and the need for customers to redesign their products and modify their software to implement our ICs in their products.

Due to our diversified product portfolio and the numerous markets and applications we serve, we target a relatively large number of competitors. We compete with Analog Devices, Broadcom, Conexant, Cypress, IDT, Marvell Technology Group, Maxim Integrated Products, MaxLinear, Microchip, Microsemi, Nordic Semiconductor, NXP Semiconductors, Qualcomm, Renesas, STMicroelectronics, Texas Instruments, Vectron International and others. We expect to face competition in the future from our current competitors, other manufacturers and designers of semiconductors and start-up semiconductor design companies. Our competitors may also offer bundled solutions offering a more complete product, which may negatively impact our competitive position despite the technical merits or advantages of our products. In addition, our customers could develop products or technologies internally that would replace their need for our products and would become a source of competition. We could also face competition from module makers or other systems suppliers that may include mixed-signal components in their products that could eliminate the need for our ICs.

Many of our competitors and potential competitors have longer operating histories, greater name recognition, access to larger customer bases, complementary product offerings, and significantly greater financial, sales and marketing, manufacturing, distribution, technical and other resources than us. Current and potential competitors have established or may establish financial and strategic relationships between themselves or with our existing or potential customers, resellers or other third parties.

Accordingly, it is possible that new competitors or alliances among competitors could emerge and rapidly acquire significant market share.

Intellectual Property

Our future success depends in part upon our proprietary technology. We seek to protect our technology through a combination of patents, copyrights, trade secrets, trademarks and confidentiality procedures. As of December 31, 2016, we had approximately 1,516 issued or pending United States and foreign patents. There can be no assurance that patents will ever be issued with respect to our patent applications. Furthermore, it is possible that any patents held by us may be invalidated, circumvented, challenged or licensed to others. In addition, there can be no assurance that such patents will provide us with competitive advantages or adequately safeguard our proprietary rights. While we continue to file new patent applications with respect to our recent developments, existing patents are granted for prescribed time periods and will expire at various times in the future.

We claim copyright protection for proprietary documentation for our products. We have filed for registration, or are in the process of filing for registration, the visual images of certain ICs with the U.S. Copyright Office. We have registered the “Silicon Labs” logo and a variety of other product and product family names as trademarks in the United States and selected foreign jurisdictions. All other trademarks, service marks or trade names appearing in this report are the property of their respective owners. We also attempt to protect our trade secrets and other proprietary information through agreements with our customers, suppliers, employees and consultants, and through other customary security measures. We intend to protect our rights vigorously, but there can be no assurance that our efforts will be successful. In addition, the laws of other countries in which our products are sold may not protect our products and intellectual property rights to the same extent as the laws of the United States.

While our ability to effectively compete depends in large part on our ability to protect our intellectual property, we believe that our technical expertise and ability to introduce new products in a timely manner will be an important factor in maintaining our competitive position.

Many participants in the semiconductor and electronics industries have a significant number of patents and have frequently demonstrated a readiness to commence litigation based on allegations of patent and other intellectual property infringement. From time to time, third parties may assert infringement claims against us. We may not prevail in any such litigation or may not be able to license any valid and infringed patents from third parties on commercially reasonable terms, if at all. Litigation, regardless of the outcome, is likely to result in substantial cost and diversion of our resources, including our management’s time. Any such litigation could materially adversely affect us.

Our licenses include industry standard licenses with our vendors, such as wafer fabrication tool libraries, third-party core libraries, computer-aided design applications and business software applications.

Employees

As of December 31, 2016, we employed 1,252 people. Our success depends on the continued service of our key technical and senior management personnel and on our ability to continue to attract, retain and motivate highly skilled analog and mixed-signal engineers. The competition for such personnel is intense. We have never had a work stoppage and none of our U.S. employees are represented by a labor organization. We consider our employee relations to be good.

Environmental Regulation

Federal, state and local regulations impose various environmental controls on the storage, use, discharge and disposal of certain chemicals and gases used in the semiconductor industry. Our compliance with these laws and regulations has not had a material impact on our financial position or results of operations.

Available Information

Our website address is www.silabs.com. Our annual report on Form 10-K, quarterly reports on Form 10-Q, current reports on Form 8-K and amendments to those reports filed or furnished pursuant to Section 13(a) or 15(d) of the Securities Exchange Act of 1934 are available through the investor relations page of our website free of charge as soon as reasonably practicable after we electronically file such material with, or furnish it to, the Securities and Exchange Commission (SEC). Our website and the information contained therein or connected thereto are not intended to be incorporated into this Annual Report on Form 10-K.

Item 1A. Risk Factors

Risks Related to our Business

We may not be able to maintain our historical growth and may experience significant period-to-period fluctuations in our revenues and operating results, which may result in volatility in our stock price

Although we have generally experienced revenue growth in our history, we may not be able to sustain this growth. We may also experience significant period-to-period fluctuations in our revenues and operating results in the future due to a number of factors, and any such variations may cause our stock price to fluctuate. In some future period our revenues or operating results may be below the expectations of public market analysts or investors. If this occurs, our stock price may drop, perhaps significantly.

A number of factors, in addition to those cited in other risk factors applicable to our business, may contribute to fluctuations in our revenues and operating results, including:

- The timing and volume of orders received from our customers;
- The timeliness of our new product introductions and the rate at which our new products may cannibalize our older products;
- The rate of acceptance of our products by our customers, including the acceptance of new products we may develop for integration in the products manufactured by such customers, which we refer to as “design wins”;
- The time lag and realization rate between “design wins” and production orders;
- The demand for, and life cycles of, the products incorporating our mixed-signal solutions;
- The rate of adoption of mixed-signal products in the markets we target;
- Deferrals or reductions of customer orders in anticipation of new products or product enhancements from us or our competitors or other providers of mixed-signal ICs;
- Changes in product mix;
- The average selling prices for our products could drop suddenly due to competitive offerings or competitive predatory pricing;
- The average selling prices for our products generally decline over time;

- Changes in market standards;
- Impairment charges related to inventory, equipment or other long-lived assets;
- The software used in our products, including software provided by third parties, may not meet the needs of our customers;
- Significant legal costs to defend our intellectual property rights or respond to claims against us; and
- The rate at which new markets emerge for products we are currently developing or for which our design expertise can be utilized to develop products for these new markets.

The markets for consumer electronics, for example, are characterized by rapid fluctuations in demand and seasonality that result in corresponding fluctuations in the demand for our products that are incorporated in such devices. Additionally, the rate of technology acceptance by our customers results in fluctuating demand for our products as customers are reluctant to incorporate a new IC into their products until the new IC has achieved market acceptance. Once a new IC achieves market acceptance, demand for the new IC can quickly accelerate to a point and then level off such that rapid historical growth in sales of a product should not be viewed as indicative of continued future growth. In addition, demand can quickly decline for a product when a new IC product is introduced and receives market acceptance. Due to the various factors mentioned above, the results of any prior quarterly or annual periods should not be relied upon as an indication of our future operating performance.

If we are unable to develop or acquire new and enhanced products that achieve market acceptance in a timely manner, our operating results and competitive position could be harmed

Our future success will depend on our ability to develop or acquire new products and product enhancements that achieve market acceptance in a timely and cost-effective manner. The development of mixed-signal ICs is highly complex, and we have at times experienced delays in completing the development and introduction of new products and product enhancements. Successful product development and market acceptance of our products depend on a number of factors, including:

- Requirements of customers;
- Accurate prediction of market and technical requirements;
- Timely completion and introduction of new designs;
- Timely qualification and certification of our products for use in our customers' products;
- Commercial acceptance and volume production of the products into which our ICs will be incorporated;
- Availability of foundry, assembly and test capacity;
- Achievement of high manufacturing yields;
- Quality, price, performance, power use and size of our products;
- Availability, quality, price and performance of competing products and technologies;
- Our customer service, application support capabilities and responsiveness;
- Successful development of our relationships with existing and potential customers;
- Technology, industry standards or end-user preferences; and
- Cooperation of third-party software providers and our semiconductor vendors to support our chips within a system.

We cannot provide any assurance that products which we recently have developed or may develop in the future will achieve market acceptance. We have introduced to market or are in development of many products. If our products fail to achieve market acceptance, or if we fail to develop new products on a timely basis that achieve market acceptance, our growth prospects, operating results and competitive position could be adversely affected. The growth of the Internet of Things (IoT) market is dependent on the adoption of industry standards to permit devices to connect and communicate with each other. If the industry cannot agree on a common set of standards, then the growth of the IoT market may be slower than expected.

Our research and development efforts are focused on a limited number of new technologies and products, and any delay in the development, or abandonment, of these technologies or products by industry participants, or their failure to achieve market acceptance, could compromise our competitive position

Our products serve as components and solutions in electronic devices in various markets. As a result, we have devoted and expect to continue to devote a large amount of resources to develop products based on new and emerging technologies and standards that will be commercially introduced in the future. Research and development expense during fiscal 2016 was \$199.7 million, or 28.6% of revenues. A number of companies are actively involved in the development of these new technologies and standards. Should any of these companies delay or abandon their efforts to develop commercially available products based on new technologies and standards, our research and development efforts with respect to these technologies and standards likely would have no appreciable value. In addition, if we do not correctly anticipate new technologies and standards, or if the products that we develop based on these new technologies and standards fail to achieve market acceptance, our competitors may be better able to address market demand than we would. Furthermore, if markets for these new technologies and standards develop later than we anticipate, or do not develop at all, demand for our products that are currently in development would suffer, resulting in lower sales of these products than we currently anticipate.

Significant litigation over intellectual property in our industry may cause us to become involved in costly and lengthy litigation which could seriously harm our business

In recent years, there has been significant litigation in the United States involving patents and other intellectual property rights. From time to time, we receive letters from various industry participants alleging infringement of patents, trademarks or misappropriation of trade secrets or from customers or suppliers requesting indemnification for claims brought against them by third parties. The exploratory nature of these inquiries has become relatively common in the semiconductor industry. We respond when we deem appropriate and as advised by legal counsel. We have been involved in litigation to protect our intellectual property rights in the past and may become involved in such litigation again in the future. We are currently involved in litigation in which we and certain of our customers have been accused of patent infringement related to our television tuner products. In the future, we may become involved in additional litigation to defend allegations of infringement asserted by others, both directly and indirectly as a result of certain industry-standard indemnities we may offer to our customers or suppliers. Legal proceedings could subject us to significant liability for damages or invalidate our proprietary rights. Legal proceedings initiated by us to protect our intellectual property rights could also result in counterclaims or countersuits against us. Any litigation, regardless of its outcome, would likely be time-consuming and expensive to resolve and would divert our management's time and attention. Intellectual property litigation also could force us to take specific actions, including:

- Cease selling or manufacturing products that use the challenged intellectual property;
- Obtain from the owner of the infringed intellectual property a right to a license to sell or use the relevant technology, which license may not be available on reasonable terms, or at all;

- Redesign those products that use infringing intellectual property; or
- Pursue legal remedies with third parties to enforce our indemnification rights, which may not adequately protect our interests.

Any acquisitions we make could disrupt our business and harm our financial condition

As part of our growth and product diversification strategy, we continue to evaluate opportunities to acquire other businesses, intellectual property or technologies that would complement our current offerings, expand the breadth of our markets or enhance our technical capabilities. The acquisitions that we have made and may make in the future entail a number of risks that could materially and adversely affect our business and operating results, including:

- Problems integrating the acquired operations, technologies or products with our existing business and products;
- Diversion of management's time and attention from our core business;
- Need for financial resources above our planned investment levels;
- Difficulties in retaining business relationships with suppliers and customers of the acquired company;
- Risks associated with entering markets in which we lack prior experience;
- Risks associated with the transfer of licenses of intellectual property;
- Increased operating costs due to acquired overhead;
- Tax issues associated with acquisitions;
- Acquisition-related disputes, including disputes over earn-outs and escrows;
- Potential loss of key employees of the acquired company; and
- Potential impairment of related goodwill and intangible assets.

Future acquisitions also could cause us to incur debt or contingent liabilities or cause us to issue equity securities that could negatively impact the ownership percentages of existing shareholders.

We may be unable to protect our intellectual property, which would negatively affect our ability to compete

Our products rely on our proprietary technology, and we expect that future technological advances made by us will be critical to sustain market acceptance of our products. Therefore, we believe that the protection of our intellectual property rights is and will continue to be important to the success of our business. We rely on a combination of patent, copyright, trademark and trade secret laws and restrictions on disclosure to protect our intellectual property rights. We also enter into confidentiality or license agreements with our employees, consultants, intellectual property providers and business partners, and control access to and distribution of our documentation and other proprietary information. Despite these efforts, unauthorized parties may attempt to copy or otherwise obtain and use our proprietary technology. Monitoring unauthorized use of our technology is difficult, and we cannot be certain that the steps we have taken will prevent unauthorized use of our technology, particularly in foreign countries where the laws may not protect our proprietary rights as fully as in the United States. We cannot be certain that patents will be issued as a result of our pending applications nor can we be certain that any issued patents would protect or benefit us or give us adequate protection from competing products. For example, issued patents may be circumvented or challenged and declared invalid or unenforceable. We also cannot be certain that others will not develop effective competing technologies on their own.

Failure to manage our distribution channel relationships could impede our future growth

The future growth of our business will depend in large part on our ability to manage our relationships with current and future distributors and sales representatives, develop additional channels for the distribution and sale of our products and manage these relationships. During fiscal 2016, 68% of our revenue was derived from distributors. As we execute our indirect sales strategy, we must manage the potential conflicts that may arise with our direct sales efforts. For example, conflicts with a distributor may arise when a customer begins purchasing directly from us rather than through the distributor. The inability to successfully execute or manage a multi-channel sales strategy could impede our future growth. In addition, relationships with our distributors often involve the use of price protection and inventory return rights. This often requires a significant amount of sales management's time and system resources to manage properly.

We depend on a limited number of customers for a significant portion of our revenues, and the loss of, or a significant reduction in orders from, any key customer could significantly reduce our revenues

The loss of any of our key customers, or a significant reduction in sales to any one of them, would significantly reduce our revenues and adversely affect our business. During fiscal 2016, our ten largest customers accounted for 25% of our revenues. Some of the markets for our products are dominated by a small number of potential customers. Therefore, our operating results in the foreseeable future will continue to depend on our ability to sell to these dominant customers, as well as the ability of these customers to sell products that incorporate our IC products. In the future, these customers may decide not to purchase our products at all, purchase fewer products than they did in the past or alter their purchasing patterns, particularly because:

- We do not have material long-term purchase contracts with our customers;
- Substantially all of our sales to date have been made on a purchase order basis, which permits our customers to cancel, change or delay product purchase commitments with little or no notice to us and without penalty;
- Some of our customers may have efforts underway to actively diversify their vendor base which could reduce purchases of our products; and
- Some of our customers have developed or acquired products that compete directly with products these customers purchase from us, which could affect our customers' purchasing decisions in the future.

Our customers regularly evaluate alternative sources of supply in order to diversify their supplier base, which increases their negotiating leverage with us and protects their ability to secure these components. We believe that any expansion of our customers' supplier bases could have an adverse effect on the prices we are able to charge and volume of product that we are able to sell to our customers, which would negatively affect our revenues and operating results.

We are subject to increased inventory risks and costs because we build our products based on forecasts provided by customers before receiving purchase orders for the products

In order to ensure availability of our products for some of our largest customers, we start the manufacturing of our products in advance of receiving purchase orders based on forecasts provided by these customers. However, these forecasts do not represent binding purchase commitments and we do not recognize sales for these products until they are shipped to the customer. As a result, we incur inventory and manufacturing costs in advance of anticipated sales. Because demand for our products may not materialize, manufacturing based on forecasts subjects us to increased risks of high inventory carrying costs, increased obsolescence and increased operating costs. These inventory risks are exacerbated when our customers purchase indirectly through contract manufacturers or hold

component inventory levels greater than their consumption rate because this causes us to have less visibility regarding the accumulated levels of inventory for such customers. A resulting write-off of unusable or excess inventories would adversely affect our operating results.

Our products are complex and may contain errors which could lead to liability, an increase in our costs and/or a reduction in our revenues

Our products are complex and may contain errors, particularly when first introduced or as new versions are released. Our products are increasingly being designed in more complex processes, include higher levels of software and hardware integration in modules and system-level solutions and/or include elements provided by third parties which further increase the risk of errors. We rely primarily on our in-house testing personnel to design test operations and procedures to detect any errors or vulnerabilities prior to delivery of our products to our customers.

Should problems occur in the operation or performance of our products, we may experience delays in meeting key introduction dates or scheduled delivery dates to our customers. These errors also could cause us to incur significant re-engineering costs, divert the attention of our engineering personnel from our product development efforts and cause significant customer relations and business reputation problems. Any defects could result in refunds or other liability or require product replacement or recall. Any of the foregoing could impose substantial costs and harm our business.

Product liability, data breach or cyber liability claims may be asserted with respect to our products. Our products are typically sold at prices that are significantly lower than the cost of the end-products into which they are incorporated. A defect or failure in our product could cause failure in our customer's end-product, so we could face claims for damages that are disproportionately higher than the revenues and profits we receive from the products involved. Furthermore, product liability risks are particularly significant with respect to medical and automotive applications because of the risk of serious harm to users of these products. There can be no assurance that any insurance we maintain will sufficiently protect us from any such claims.

We rely on third parties to manufacture, assemble and test our products and the failure to successfully manage our relationships with our manufacturers and subcontractors would negatively impact our ability to sell our products

We do not have our own wafer fab manufacturing facilities. Therefore, we rely on third-party vendors to manufacture the products we design. We also currently rely on Asian third-party assembly subcontractors to assemble and package the silicon chips provided by the wafers for use in final products. Additionally, we rely on these offshore subcontractors for a substantial portion of the testing requirements of our products prior to shipping. We expect utilization of third-party subcontractors to continue in the future.

The cyclical nature of the semiconductor industry drives wide fluctuations in available capacity at third-party vendors. On occasion, we have been unable to adequately respond to unexpected increases in customer demand due to capacity constraints and, therefore, were unable to benefit from this incremental demand. We may be unable to obtain adequate foundry, assembly or test capacity from our third-party subcontractors to meet our customers' delivery requirements even if we adequately forecast customer demand.

There are significant risks associated with relying on these third-party foundries and subcontractors, including:

- Failure by us, our customers or their end customers to qualify a selected supplier;
- Potential insolvency of the third-party subcontractors;

- Reduced control over delivery schedules and quality;
- Limited warranties on wafers or products supplied to us;
- Potential increases in prices or payments in advance for capacity;
- Increased need for international-based supply, logistics and financial management;
- Their inability to supply or support new or changing packaging technologies; and
- Low test yields.

We typically do not have long-term supply contracts with our third-party vendors which obligate the vendor to perform services and supply products to us for a specific period, in specific quantities, and at specific prices. Our third-party foundry, assembly and test subcontractors typically do not guarantee that adequate capacity will be available to us within the time required to meet demand for our products. In the event that these vendors fail to meet our demand for whatever reason, we expect that it would take up to 12 months to transition performance of these services to new providers. Such a transition may also require qualification of the new providers by our customers or their end customers.

Most of the silicon wafers for the products that we have sold were manufactured either by Taiwan Semiconductor Manufacturing Co. (TSMC) or TSMC's affiliates or by Semiconductor Manufacturing International Corporation (SMIC). Our customers typically complete their own qualification process. If we fail to properly balance customer demand across the existing semiconductor fabrication facilities that we utilize or are required by our foundry partners to increase, or otherwise change the number of fab lines that we utilize for our production, we might not be able to fulfill demand for our products and may need to divert our engineering resources away from new product development initiatives to support the fab line transition, which would adversely affect our operating results.

Our customers require our products to undergo a lengthy and expensive qualification process without any assurance of product sales

Prior to purchasing our products, our customers require that our products undergo an extensive qualification process, which involves testing of the products in the customer's system as well as rigorous reliability testing. This qualification process may continue for six months or longer. However, qualification of a product by a customer does not ensure any sales of the product to that customer. Even after successful qualification and sales of a product to a customer, a subsequent revision to the product or software, changes in the IC's manufacturing process or the selection of a new supplier by us may require a new qualification process, which may result in delays and in us holding excess or obsolete inventory. After our products are qualified, it can take an additional six months or more before the customer commences volume production of components or devices that incorporate our products. Despite these uncertainties, we devote substantial resources, including design, engineering, sales, marketing and management efforts, toward qualifying our products with customers in anticipation of sales. If we are unsuccessful or delayed in qualifying any of our products with a customer, such failure or delay would preclude or delay sales of such product to the customer, which may impede our growth and cause our business to suffer.

We are a global company, which subjects us to additional business risks including logistical and financial complexity, political instability and currency fluctuations

We have established international subsidiaries and have opened offices in international markets to support our activities in Asia, the Americas and Europe. This has included the establishment of a headquarters in Singapore for non-U.S. operations. The percentage of our revenues derived from outside of the United States was 86% during fiscal 2016. We may not be able to maintain or increase

global market demand for our products. Our international operations are subject to a number of risks, including:

- Complexity and costs of managing international operations and related tax obligations, including our headquarters for non-U.S. operations in Singapore;
- Protectionist laws and business practices;
- Difficulties related to the protection of our intellectual property rights in some countries;
- Multiple, conflicting and changing tax and other laws and regulations that may impact both our international and domestic tax and other liabilities and result in increased complexity and costs;
- Longer sales cycles;
- Greater difficulty in accounts receivable collection and longer collection periods;
- High levels of distributor inventory subject to price protection and rights of return to us;
- Political and economic instability;
- Greater difficulty in hiring and retaining qualified personnel; and
- The need to have business and operations systems that can meet the needs of our international business and operating structure.

To date, substantially all of our sales to international customers and purchases of components from international suppliers have been denominated in U.S. dollars. As a result, an increase in the value of the U.S. dollar relative to foreign currencies could make our products more expensive for our international customers to purchase, thus rendering our products less competitive. Similarly, a decrease in the value of the U.S. dollar could reduce our buying power with respect to international suppliers.

Our inability to manage growth could materially and adversely affect our business

Our past growth has placed, and any future growth of our operations will continue to place, a significant strain on our management personnel, systems and resources. We anticipate that we will need to implement a variety of new and upgraded sales, operational and financial enterprise-wide systems, information technology infrastructure, procedures and controls, including the improvement of our accounting and other internal management systems to manage this growth and maintain compliance with regulatory guidelines, including Sarbanes-Oxley Act requirements. To the extent our business grows, our internal management systems and processes will need to improve to ensure that we remain in compliance. We also expect that we will need to continue to expand, train, manage and motivate our workforce. All of these endeavors will require substantial management effort, and we anticipate that we will require additional management personnel and internal processes to manage these efforts and to plan for the succession from time to time of certain persons who have been key management and technical personnel. If we are unable to effectively manage our expanding global operations, including our international headquarters in Singapore, our business could be materially and adversely affected.

Our products incorporate technology licensed from third parties

We incorporate technology (including software) licensed from third parties in our products. We could be subjected to claims of infringement regardless of our lack of involvement in the development of the licensed technology. Although a third-party licensor is typically obligated to indemnify us if the licensed technology infringes on another party's intellectual property rights, such indemnification is typically limited in amount and may be worthless if the licensor becomes insolvent. See *Significant litigation over intellectual property in our industry may cause us to become involved in costly and lengthy litigation which could seriously harm our business*. Furthermore, any failure of third-party technology to perform properly would adversely affect sales of our products incorporating such technology.

We are subject to risks relating to product concentration

We derive a substantial portion of our revenues from a limited number of products, and we expect these products to continue to account for a large percentage of our revenues in the near term. Continued market acceptance of these products, is therefore, critical to our future success. In addition, substantially all of our products that we have sold include technology related to one or more of our issued U.S. patents. If these patents are found to be invalid or unenforceable, our competitors could introduce competitive products that could reduce both the volume and price per unit of our products. Our business, operating results, financial condition and cash flows could therefore be adversely affected by:

- A decline in demand for any of our more significant products;
- Failure of our products to achieve continued market acceptance;
- Competitive products;
- New technological standards or changes to existing standards that we are unable to address with our products;
- A failure to release new products or enhanced versions of our existing products on a timely basis; and
- The failure of our new products to achieve market acceptance.

We are subject to credit risks related to our accounts receivable

We do not generally obtain letters of credit or other security for payment from customers, distributors or contract manufacturers. Accordingly, we are not protected against accounts receivable default or bankruptcy by these entities. Our ten largest customers or distributors represent a substantial majority of our accounts receivable. If any such customer or distributor, or a material portion of our smaller customers or distributors, were to become insolvent or otherwise not satisfy their obligations to us, we could be materially harmed.

We depend on our key personnel to manage our business effectively in a rapidly changing market, and if we are unable to retain our current personnel and hire additional personnel, our ability to develop and successfully market our products could be harmed

We believe our future success will depend in large part upon our ability to attract and retain highly skilled managerial, engineering, sales and marketing personnel. We believe that our future success will be dependent on retaining the services of our key personnel, developing their successors and certain internal processes to reduce our reliance on specific individuals, and on properly managing the transition of key roles when they occur. There is currently a shortage of qualified personnel with significant experience in the design, development, manufacturing, marketing and sales of analog and mixed-signal products. In particular, there is a shortage of engineers who are familiar with the intricacies of the design and manufacturability of analog elements, and competition for such personnel is intense. Our key technical personnel represent a significant asset and serve as the primary source for our technological and product innovations. We may not be successful in attracting and retaining sufficient numbers of technical personnel to support our anticipated growth. The loss of any of our key employees or the inability to attract or retain qualified personnel both in the United States and internationally, including engineers, sales, applications and marketing personnel, could delay the development and introduction of, and negatively impact our ability to sell, our products.

Any dispositions could harm our financial condition

Any disposition of a product line would entail a number of risks that could materially and adversely affect our business and operating results, including:

- Diversion of management's time and attention from our core business;
- Difficulties separating the divested business;
- Risks to relations with customers who previously purchased products from our disposed product line;
- Reduced leverage with suppliers due to reduced aggregate volume;
- Risks related to employee relations;
- Risks associated with the transfer and licensing of intellectual property;
- Security risks and other liabilities related to the transition services provided in connection with the disposition;
- Tax issues associated with dispositions; and
- Disposition-related disputes, including disputes over earn-outs and escrows.

Our stock price may be volatile

The market price of our common stock has been volatile in the past and may be volatile in the future. The market price of our common stock may be significantly affected by the following factors:

- Actual or anticipated fluctuations in our operating results;
- Changes in financial estimates by securities analysts or our failure to perform in line with such estimates;
- Changes in market valuations of other technology companies, particularly semiconductor companies;
- Announcements by us or our competitors of significant technical innovations, acquisitions, strategic partnerships, joint ventures or capital commitments;
- Introduction of technologies or product enhancements that reduce the need for our products;
- The loss of, or decrease in sales to, one or more key customers;
- A large sale of stock by a significant shareholder;
- Dilution from the issuance of our stock in connection with acquisitions;
- The addition or removal of our stock to or from a stock index fund;
- Departures of key personnel;
- The required expensing of stock awards; and
- The required changes in our reported revenue and revenue recognition accounting policy expected under Accounting Standards Update (ASU) No. 2014-09, *Revenue from Contracts with Customers (Topic 606)*.

The stock market has experienced extreme volatility that often has been unrelated to the performance of particular companies. These market fluctuations may cause our stock price to fall regardless of our performance.

Most of our current manufacturers, assemblers, test service providers, distributors and customers are concentrated in the same geographic region, which increases the risk that a natural disaster, epidemic, labor strike, war or political unrest could disrupt our operations or sales

Most of our foundries and several of our assembly and test subcontractors' sites are located in Taiwan and most of our other foundry, assembly and test subcontractors are located in the Pacific Rim region. In addition, many of our customers are located in the Pacific Rim region. The risk of earthquakes in Taiwan and the Pacific Rim region is significant due to the proximity of major earthquake fault lines in the area. Earthquakes, tsunamis, fire, flooding, lack of water or other natural disasters, an epidemic, political unrest, war, labor strikes or work stoppages in countries where our semiconductor manufacturers, assemblers and test subcontractors are located, likely would result in the disruption of our foundry, assembly or test capacity. There can be no assurance that alternate capacity could be obtained on favorable terms, if at all.

A natural disaster, epidemic, labor strike, war or political unrest where our customers' facilities are located would likely reduce our sales to such customers. North Korea's geopolitical maneuverings have created unrest. Such unrest could create economic uncertainty or instability, could escalate to war or otherwise adversely affect South Korea and our South Korean customers and reduce our sales to such customers, which would materially and adversely affect our operating results. In addition, a significant portion of the assembly and testing of our products occurs in South Korea. Any disruption resulting from these events could also cause significant delays in shipments of our products until we are able to shift our manufacturing, assembling or testing from the affected subcontractor to another third-party vendor.

The semiconductor manufacturing process is highly complex and, from time to time, manufacturing yields may fall below our expectations, which could result in our inability to satisfy demand for our products in a timely manner and may decrease our gross margins due to higher unit costs

The manufacturing of our products is a highly complex and technologically demanding process. Although we work closely with our foundries and assemblers to minimize the likelihood of reduced manufacturing yields, we have from time to time experienced lower than anticipated manufacturing yields. Changes in manufacturing processes or the inadvertent use of defective or contaminated materials could result in lower than anticipated manufacturing yields or unacceptable performance deficiencies, which could lower our gross margins. If our foundries fail to deliver fabricated silicon wafers of satisfactory quality in a timely manner, we will be unable to meet our customers' demand for our products in a timely manner, which would adversely affect our operating results and damage our customer relationships.

We depend on our customers to support our products, and some of our customers offer competing products

We rely on our customers to provide hardware, software, intellectual property indemnification and other technical support for the products supplied by our customers. If our customers do not provide the required functionality or if our customers do not provide satisfactory support for their products, the demand for these devices that incorporate our products may diminish or we may otherwise be materially adversely affected. Any reduction in the demand for these devices would significantly reduce our revenues.

In certain products, some of our customers offer their own competitive products. These customers may find it advantageous to support their own offerings in the marketplace in lieu of promoting our products.

Our debt could adversely affect our operations and financial condition

We believe we have the ability to service our debt under our credit facilities, but our ability to make the required payments thereunder when due depends upon our future performance, which will be subject to general economic conditions, industry cycles and other factors affecting our operations, including risk factors described under this Item 1A, many of which are beyond our control. Our credit facilities also contain covenants, including financial covenants. If we breach any of the covenants under our credit facilities and do not obtain appropriate waivers, then, subject to any applicable cure periods, our outstanding indebtedness thereunder could be declared immediately due and payable.

We could seek to raise additional debt or equity capital in the future, but additional capital may not be available on terms acceptable to us, or at all

We believe that our existing cash, cash equivalents, investments and credit under our credit facilities will be sufficient to meet our working capital needs, capital expenditures, investment requirements and commitments for at least the next 12 months. However, our ability to borrow further under the credit facilities is dependent upon our ability to satisfy various conditions, covenants and representations. It is possible that we may need to raise additional funds to finance our activities or to facilitate acquisitions of other businesses, products, intellectual property or technologies. We believe we could raise these funds, if needed, by selling equity or debt securities to the public or to selected investors. In addition, even though we may not need additional funds, we may still elect to sell additional equity or debt securities or obtain credit facilities for other reasons. However, we may not be able to obtain additional funds on favorable terms, or at all. If we decide to raise additional funds by issuing equity or convertible debt securities, the ownership percentages of existing shareholders would be reduced.

We have limited resources compared to some of our current and potential competitors and we may not be able to compete effectively and increase market share

Some of our current and potential competitors have longer operating histories, significantly greater resources and name recognition and a larger base of customers than we have. As a result, these competitors may have greater credibility with our existing and potential customers. They also may be able to adopt more aggressive pricing policies and devote greater resources to the development, promotion and sale of their products than we can to ours. In addition, some of our current and potential competitors have already established supplier or joint development relationships with the decision makers at our current or potential customers. These competitors may be able to leverage their existing relationships to discourage their customers from purchasing products from us or persuade them to replace our products with their products. Our competitors may also offer bundled solutions offering a more complete product despite the technical merits or advantages of our products. These competitors may elect not to support our products which could complicate our sales efforts. These and other competitive pressures may prevent us from competing successfully against current or future competitors, and may materially harm our business. Competition could decrease our prices, reduce our sales, lower our gross margins and/or decrease our market share.

Provisions in our charter documents and Delaware law could prevent, delay or impede a change in control of us and may reduce the market price of our common stock

Provisions of our certificate of incorporation and bylaws could have the effect of discouraging, delaying or preventing a merger or acquisition that a stockholder may consider favorable. For example, our certificate of incorporation and bylaws provide for:

- The division of our Board of Directors into three classes to be elected on a staggered basis, one class each year;

- The ability of our Board of Directors to issue shares of our preferred stock in one or more series without further authorization of our stockholders;
- A prohibition on stockholder action by written consent;
- Elimination of the right of stockholders to call a special meeting of stockholders;
- A requirement that stockholders provide advance notice of any stockholder nominations of directors or any proposal of new business to be considered at any meeting of stockholders; and
- A requirement that a supermajority vote be obtained to amend or repeal certain provisions of our certificate of incorporation.

We also are subject to the anti-takeover laws of Delaware which may discourage, delay or prevent someone from acquiring or merging with us, which may adversely affect the market price of our common stock.

Risks related to our industry

We are subject to the cyclical nature of the semiconductor industry, which has been subject to significant fluctuations

The semiconductor industry is highly cyclical and is characterized by constant and rapid technological change, rapid product obsolescence and price erosion, evolving standards, short product life cycles and wide fluctuations in product supply and demand. The industry has experienced significant fluctuations, often connected with, or in anticipation of, maturing product cycles and new product introductions of both semiconductor companies' and their customers' products and fluctuations in general economic conditions. Deteriorating general worldwide economic conditions, including reduced economic activity, concerns about credit and inflation, increased energy costs, decreased consumer confidence, reduced corporate profits, decreased spending and similar adverse business conditions, would make it very difficult for our customers, our vendors, and us to accurately forecast and plan future business activities and could cause U.S. and foreign businesses to slow spending on our products. We cannot predict the timing, strength, or duration of any economic slowdown or economic recovery. If the economy or markets in which we operate deteriorate, our business, financial condition, and results of operations would likely be materially and adversely affected.

Downturns have been characterized by diminished product demand, production overcapacity, high inventory levels and accelerated erosion of average selling prices. In the recent past, we believe the semiconductor industry suffered a downturn due in large part to adverse conditions in the global credit and financial markets, including diminished liquidity and credit availability, declines in consumer confidence, declines in economic growth, increased unemployment rates and general uncertainty regarding the economy. Such downturns may have a material adverse effect on our business and operating results.

Upturns have been characterized by increased product demand and production capacity constraints created by increased competition for access to third-party foundry, assembly and test capacity. We are dependent on the availability of such capacity to manufacture, assemble and test our products. None of our third-party foundry, assembly or test subcontractors have provided assurances that adequate capacity will be available to us.

The average selling prices of our products could decrease rapidly which may negatively impact our revenues and gross margins

We may experience substantial period-to-period fluctuations in future operating results due to the erosion of our average selling prices. We have reduced the average unit price of our products in anticipation of or in response to competitive pricing pressures, new product introductions by us or our

competitors and other factors. If we are unable to offset any such reductions in our average selling prices by increasing our sales volumes, increasing our sales content per application or reducing production costs, our gross margins and revenues will suffer. To maintain our gross margin percentage, we will need to develop and introduce new products and product enhancements on a timely basis and continually reduce our costs. Our failure to do so could cause our revenues and gross margin percentage to decline.

Competition within the numerous markets we target may reduce sales of our products and reduce our market share

The markets for semiconductors in general, and for mixed-signal products in particular, are intensely competitive. We expect that the market for our products will continually evolve and will be subject to rapid technological change. In addition, as we target and supply products to numerous markets and applications, we face competition from a relatively large number of competitors. We compete with Analog Devices, Broadcom, Conexant, Cypress, IDT, Marvell Technology Group, Maxim Integrated Products, MaxLinear, Microchip, Microsemi, Nordic Semiconductor, NXP Semiconductors, Qualcomm, Renesas, STMicroelectronics, Texas Instruments, Vectron International and others. We expect to face competition in the future from our current competitors, other manufacturers and designers of semiconductors, and start-up semiconductor design companies. As the markets for communications products grow, we also may face competition from traditional communications device companies. These companies may enter the mixed-signal semiconductor market by introducing their own products or by entering into strategic relationships with or acquiring other existing providers of semiconductor products. In addition, large companies may restructure their operations to create separate companies or may acquire new businesses that are focused on providing the types of products we produce or acquire our customers.

We may be the victim of cyber-attacks against our products and our networks, which could lead to liability and damage our reputation and financial results

Many of our products focus on wireless connectivity and the IoT market and such connectivity may make these products particularly susceptible to cyber-attacks. We routinely face attacks attempting to breach our security protocols, gain access to or disrupt our computerized systems, or steal proprietary company, customer, partner or employee information. These attacks are sometimes successful. We may be subject to security breaches, employee error, theft, malfeasance, phishing schemes, ransomware, faulty password or data security management, or other irregularities. The theft, loss or misuse of personal or business data collected, used, stored or transferred by us to run our business could result in increased security costs or costs related to defending legal claims. Industrial espionage, theft or loss of our intellectual property data could lead to counterfeit products or harm the competitive position of our products and services. Costs to comply with and implement privacy-related and data protection measures could be significant. Federal, state or international privacy-related or data protection laws and regulations could result in proceedings against us by governmental entities or others. Attempted or successful attacks against our products and services could damage our reputation with customers or users and reduce demand for our products and services.

We may be subject to information technology failures that could damage our reputation, business operations and financial condition

We rely on information technology for the effective operation of our business. Our systems are subject to damage or interruption from a number of potential sources, including natural disasters, accidents, power disruptions, telecommunications failures, acts of terrorism or war, computer viruses, theft, physical or electronic break-ins, cyber-attacks, sabotage, vandalism, or similar events or disruptions. Our security measures may not detect or prevent such security breaches. Any such

compromise of our information security could result in the theft or unauthorized publication or use of our confidential business or proprietary information, result in the unauthorized release of customer, supplier or employee data, result in a violation of privacy or other laws, expose us to a risk of litigation or damage our reputation. In addition, our inability to use or access information systems at critical points in time could unfavorably impact the timely and efficient operation of our business, which could negatively affect our business and operating results.

Third parties with which we conduct business, such as foundries, assembly and test contractors, distributors and customers, have access to certain portions of our sensitive data. In the event that these third parties do not properly safeguard our data that they hold, security breaches could result and negatively impact our reputation, business operations and financial results.

Our products must conform to industry standards and technology in order to be accepted by end users in our markets

Generally, our products comprise only a part of a device. All components of such devices must uniformly comply with industry standards in order to operate efficiently together. We depend on companies that provide other components of the devices to support prevailing industry standards. Many of these companies are significantly larger and more influential in affecting industry standards than we are. Some industry standards may not be widely adopted or implemented uniformly, and competing standards may emerge that may be preferred by our customers or end users. If larger companies do not support the same industry standards that we do, or if competing standards emerge, market acceptance of our products could be adversely affected which would harm our business.

Products for certain applications are based on industry standards that are continually evolving. Our ability to compete in the future will depend on our ability to identify and ensure compliance with these evolving industry standards. The emergence of new industry standards could render our products incompatible with products developed by other suppliers. As a result, we could be required to invest significant time and effort and to incur significant expense to redesign our products to ensure compliance with relevant standards. If our products are not in compliance with prevailing industry standards for a significant period of time, we could miss opportunities to achieve crucial design wins.

Our pursuit of necessary technological advances may require substantial time and expense. We may not be successful in developing or using new technologies or in developing new products or product enhancements that achieve market acceptance. If our products fail to achieve market acceptance, our growth prospects, operating results and competitive position could be adversely affected.

Customer demands and new regulations related to conflict-free minerals may adversely affect us

The Dodd-Frank Wall Street Reform and Consumer Protection Act imposes new disclosure requirements regarding the use of “conflict” minerals mined from the Democratic Republic of Congo and adjoining countries in products, whether or not these products are manufactured by third parties. These new requirements could affect the pricing, sourcing and availability of minerals used in the manufacture of semiconductor devices (including our products). There will be additional costs associated with complying with the disclosure requirements, such as costs related to determining the source of any conflict minerals used in our products. Our supply chain is complex and we may be unable to verify the origins for all metals used in our products. We may also encounter challenges with our customers and stockholders if we are unable to certify that our products are conflict free.

Item 1B. Unresolved Staff Comments

None.

Item 2. Properties

Our corporate headquarters, housing engineering, sales and marketing, administration and test operations, is located in Austin, Texas. Our headquarters facilities consist of two buildings, which we own, that are located on land which we have leased through 2099. The buildings contain approximately 441,000 square feet of floor space, of which approximately 130,000 square feet were leased to other tenants. In addition to these properties, we lease smaller facilities in various locations in the United States, Brazil, Canada, China, Finland, France, Germany, Hungary, India, Italy, Japan, Norway, Singapore, South Korea, Taiwan and the United Kingdom for engineering, sales and marketing, administrative and manufacturing support activities. We believe that these facilities are suitable and adequate to meet our current operating needs.

Item 3. Legal Proceedings

Patent Litigation

On January 21, 2014, Cresta Technology Corporation (“Cresta Technology”), a Delaware corporation, filed a lawsuit against us, Samsung Electronics Co., Ltd., Samsung Electronics America, Inc., LG Electronics Inc. and LG Electronics U.S.A., Inc. in the United States District Court in the District of Delaware, alleging infringement of three United States Patents (the “Cresta Patents”). The Delaware District Court action has been stayed.

On January 28, 2014, Cresta Technology also filed a complaint with the United States International Trade Commission (“ITC”) alleging infringement of the same patents. On September 29, 2015, the ITC issued its Final Determination, finding that all the patent claims asserted against our products were either invalid or not infringed and that Cresta Technology failed to establish the ITC’s domestic industry requirement. The ITC found no violation by us and terminated the investigation. On November 30, 2015, Cresta Technology filed an appeal of the ITC decision to the Federal Circuit. On March 8, 2016, pursuant to a stipulated dismissal, the Federal Circuit dismissed Cresta Technology’s appeal in its entirety.

In a parallel process, we challenged the validity of the claims of the Cresta Patents asserted in the ITC investigation through a series of *Inter-Partes* Review (IPR) proceedings at the Patent Trial and Appeal Board (PTAB) of the United States Patent and Trademark Office (USPTO). On October 21, 2015, the USPTO issued final written decisions on a first set of reviewed claims finding all of the reviewed claims invalid. On December 18, 2015, Cresta Technology appealed those adverse decisions to the United States Court of Appeals for the Federal Circuit as to this first USPTO determination. The Federal Circuit summarily affirmed the USPTO’s first determination on November 8, 2016 and the mandate issued on December 16, 2016, rendering the USPTO’s determination final.

The USPTO instituted a second set of IPR proceedings against a second set of the remaining claims. On August 11, 2016, the PTAB issued its final written decisions in these proceedings and found all of these remaining claims unpatentable. On October 13, 2016, the patent owner, now known as CF Crespe LLC, filed a notice of appeal with the Federal Circuit seeking to overturn the USPTO’s final written decision as to a subset of the claims found unpatentable in this second set of IPR proceedings. That appeal is currently in briefing. No hearing date has been set.

On March 18, 2016, Cresta Technology filed for chapter 7 bankruptcy in the United States Bankruptcy Court for the Northern District of California.

On May 13, 2016, the Bankruptcy Court approved an agreement for DBD Credit Funding LLC (“DBD”) to buy Cresta Technology’s entire IP portfolio and certain related litigation. Following that sale, DBD (through an apparent assignee, CF Crespe LLC) has substituted in the Delaware District Court action, the appeal proceedings at the U.S. Court of Appeals for the Federal Circuit for the first

set of IPR proceedings and the USPTO PTAB proceedings for the second set of IPRs replacing Cresta Technology.

On July 16, 2014, we filed a lawsuit against Cresta Technology in the United States District Court in the Northern District of California alleging infringement of six United States Patents. We are seeking a permanent injunction and an award of damages and attorney fees. As a result of the chapter 7 bankruptcy filing by Cresta Technology, these proceedings were stayed. However, as a result of the May 13, 2016 sale order by the Bankruptcy Court, DBD and CF Crespe LLC were ordered to substitute in as Defendant for Cresta Technology. DBD and CF Crespe LLC have appealed the Bankruptcy Court's order in that regard. Subject to that appeal, the Company's patent infringement trial against DBD and CF Crespe LLC is set to begin October 2, 2017.

As is customary in the semiconductor industry, we provide indemnification protection to our customers for intellectual property claims related to our products. We have not accrued any material liability on our Consolidated Balance Sheet related to such indemnification obligations in connection with the Cresta Technology litigation.

We intend to continue to vigorously defend against Cresta Technology's (now DBD and CF Crespe LLC's) allegations and to continue to pursue our claims against Cresta and their patents. At this time, we cannot predict the outcome of these matters or the resulting financial impact to us, if any.

Other

We are involved in various other legal proceedings that have arisen in the normal course of business. While the ultimate results of these matters cannot be predicted with certainty, we do not expect them to have a material adverse effect on our Consolidated Financial Statements.

Item 4. Mine Safety Disclosures

Not applicable.

Part II

Item 5. Market for Registrant's Common Equity, Related Stockholder Matters and Issuer Purchases of Equity Securities

Market Information and Holders

Our registration statement (Registration No. 333-94853) under the Securities Act of 1933, as amended, relating to our initial public offering of our common stock became effective on March 23, 2000. Our common stock is quoted on the NASDAQ National Market (NASDAQ) under the symbol "SLAB". The table below shows the high and low per-share sales prices of our common stock for the periods indicated, as reported by NASDAQ. As of January 23, 2017, there were 85 holders of record of our common stock.

	<u>High</u>	<u>Low</u>
Fiscal Year 2015		
First Quarter	\$52.83	\$42.61
Second Quarter	58.54	49.85
Third Quarter	53.84	39.33
Fourth Quarter	54.72	42.06
Fiscal Year 2016		
First Quarter	\$48.00	\$36.56
Second Quarter	51.00	42.63
Third Quarter	59.35	45.94
Fourth Quarter	68.95	55.97

Dividend Policy

We have never declared or paid any cash dividends on our common stock and we do not intend to pay cash dividends in the foreseeable future. We currently expect to retain any future earnings to fund the operation and expansion of our business.

Stock Performance Graph

The graph depicted below shows a comparison of cumulative total stockholder returns for an investment in Silicon Laboratories Inc. common stock, the NASDAQ Composite Index and the PHLX Semiconductor Index.

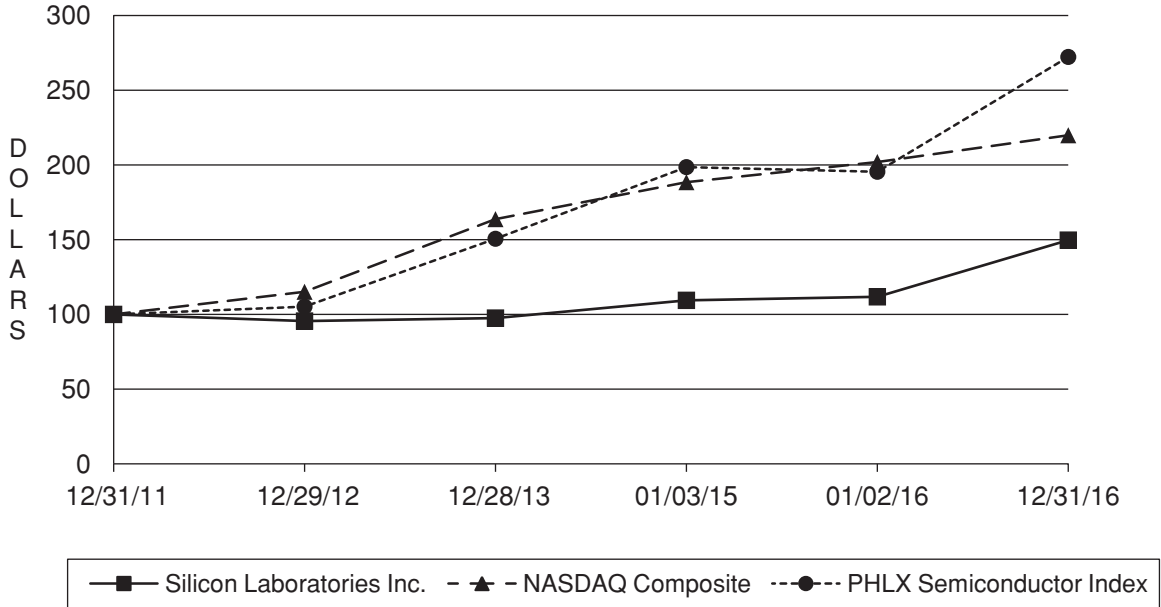

Company / Index	12/31/11	12/29/12	12/28/13	01/03/15	01/02/16	12/31/16
Silicon Laboratories Inc.	\$100.00	\$ 95.56	\$ 97.54	\$109.42	\$111.79	\$149.70
NASDAQ Composite	\$100.00	\$115.15	\$163.76	\$188.49	\$201.98	\$219.89
PHLX Semiconductor Index	\$100.00	\$105.20	\$150.62	\$198.57	\$195.45	\$272.30

- (1) The graph assumes that \$100 was invested in our common stock and in each index at the market close on December 31, 2011, and that all dividends were reinvested. No cash dividends have been declared on our common stock.
- (2) Stockholder returns over the indicated period should not be considered indicative of future stockholder returns.

Issuer Purchases of Equity Securities

The following table summarizes repurchases of our common stock during the three months ended December 31, 2016 (in thousands, except per share amounts):

Period	Total Number of Shares Purchased	Average Price Paid per Share	Total Number of Shares Purchased as Part of Publicly Announced Plans or Programs	Approximate Dollar Value of Shares that May Yet Be Purchased Under the Plans or Programs
October 2, 2016 - October 29, 2016	—	\$—	—	\$59,474
October 30, 2016 - November 26, 2016	—	\$—	—	\$59,474
November 27, 2016 - December 31, 2016	—	\$—	—	\$59,474
Total	—	\$—	—	

In August 2015, the Board of Directors authorized a program to repurchase up to \$100 million of our common stock through December 2016. In January 2017, the Board of Directors authorized a program to repurchase up to \$100 million of our common stock through December 2017. The programs allow for repurchases to be made in the open market or in private transactions, including structured or accelerated transactions, subject to applicable legal requirements and market conditions.

Item 6. Selected Financial Data

Please read this selected consolidated financial data in conjunction with “Management’s Discussion and Analysis of Financial Condition and Results of Operations,” our Consolidated Financial Statements and the notes to those statements included in this Form 10-K.

	Fiscal Year				
	2016	2015	2014	2013	2012
	(in thousands, except per share data)				
<i>Consolidated Statements of Income Data</i>					
Revenues	\$ 697,626	\$ 644,826	\$ 620,704	\$580,087	\$563,294
Operating income	\$ 66,277	\$ 32,234	\$ 51,421	\$ 64,310	\$ 85,675
Net income	\$ 61,494	\$ 29,586	\$ 38,021	\$ 49,819	\$ 63,548
Earnings per share:					
Basic	\$ 1.47	\$ 0.70	\$ 0.88	\$ 1.17	\$ 1.51
Diluted	\$ 1.45	\$ 0.69	\$ 0.87	\$ 1.14	\$ 1.47
<i>Consolidated Balance Sheet Data</i>					
Cash, cash equivalents and investments (1)	\$ 300,263	\$ 250,112	\$ 342,614	\$286,025	\$293,360
Working capital	351,156	280,819	365,223	350,170	361,304
Total assets	1,081,844	1,011,463	1,042,561	991,150	871,966
Long-term obligations	115,191	108,028	121,191	143,441	115,615
Total stockholders’ equity	826,958	761,114	758,056	738,562	649,973

(1) Reflects repurchases of \$41 million, \$71 million, \$72 million, \$26 million and \$62 million of our common stock in fiscal 2016, 2015, 2014, 2013 and 2012, respectively. Includes \$5 million, \$7 million, \$7 million, \$11 million and \$11 million of long-term auction-rate securities investments in fiscal 2016, 2015, 2014, 2013 and 2012, respectively.

Item 7. Management’s Discussion and Analysis of Financial Condition and Results of Operations

The following discussion and analysis of financial condition and results of operations should be read in conjunction with the Consolidated Financial Statements and related notes thereto included elsewhere in this report. This discussion contains forward-looking statements. Please see the “Cautionary Statement” and “Risk Factors” above for discussions of the uncertainties, risks and assumptions associated with these statements. Our fiscal year-end financial reporting periods are a 52- or 53-week year ending on the Saturday closest to December 31. Fiscal 2016 and 2015 were 52-week years and ended on December 31, 2016 and January 2, 2016, respectively. Fiscal 2014 was a 53-week year with the extra week occurring in the fourth quarter of the year and ended on January 3, 2015.

Overview

We are a provider of silicon, software and solutions for the Internet of Things (IoT), Internet infrastructure, industrial, consumer and automotive markets. We solve some of the electronics industry’s toughest problems, providing customers with significant advantages in performance, energy savings, connectivity and design simplicity. Mixed-signal integrated circuits (ICs) are electronic components that convert real-world analog signals, such as sound and radio waves, into digital signals that electronic products can process. Therefore, mixed-signal ICs are critical components in products addressing a variety of markets, including industrial, communications, consumer and automotive.

As a fabless semiconductor company, we rely on third-party semiconductor fabricators in Asia, and to a lesser extent the United States and Europe, to manufacture the silicon wafers that reflect our IC designs. Each wafer contains numerous die, which are cut from the wafer to create a chip for an IC. We rely on third parties in Asia to assemble, package, and, in most cases, test these devices and ship these units to our customers. Testing performed by such third parties facilitates faster delivery of products to our customers (particularly those located in Asia), shorter production cycle times, lower inventory requirements, lower costs and increased flexibility of test capacity.

Our expertise in analog-intensive, high-performance, mixed-signal ICs and software enables us to develop highly differentiated solutions that address multiple markets. We group our products into the following categories:

- Internet of Things products, which include our microcontroller (MCU), wireless, sensor and analog products;
- Broadcast products, which include our broadcast consumer and automotive products;
- Infrastructure products, which include our timing products (clocks and oscillators), and isolation devices; and
- Access products, which include our Voice over IP (VoIP) products, embedded modems and our Power over Ethernet (PoE) devices.

Current Period Highlights

Revenues increased \$52.8 million in fiscal 2016 compared to fiscal 2015, primarily due to increased revenues from our IoT and Infrastructure products offset by decreases in revenues from our Access and Broadcast products. Infrastructure revenues in fiscal 2016 included \$5.0 million from the sale of patents. Gross margin increased \$40.7 million during the same period due primarily to increased product sales. Operating expenses increased \$6.7 million in fiscal 2016 compared to fiscal 2015 due primarily to increased personnel-related expenses and new product introduction costs, offset by adjustments to the fair value of acquisition-related contingent consideration and decreased acquisition-related costs and legal fees.

We ended fiscal 2016 with \$295.1 million in cash, cash equivalents and short-term investments. Net cash provided by operating activities was \$128.9 million during fiscal 2016. Accounts receivable increased to \$74.4 million at December 31, 2016 compared to January 2, 2016, representing 37 days sales outstanding (DSO). Inventory increased to \$59.6 million at December 31, 2016 compared to January 2, 2016, representing 73 days of inventory (DOI). In fiscal 2016, we repurchased 0.9 million shares of our common stock for \$40.5 million. In fiscal 2016, we settled the remaining amount of the contingent consideration to be paid in connection with the Energy Micro acquisition. The settlement amount was \$16.0 million.

Through acquisitions and internal development efforts, we have continued to diversify our product portfolio and introduce new products and solutions with added functionality and further integration. In fiscal 2016, we acquired Micrium, LLC. Micrium is a supplier of real-time operating system (RTOS) software for the IoT. See Note 8, *Acquisitions*, to the Consolidated Financial Statements for additional information.

In fiscal 2016, we introduced two new wireless occupancy sensor and smart outlet reference designs for the home automation market; new audio software products for the automotive radio market; a Bluetooth software solution that enables developers to efficiently create Apple® HomeKit™-enabled accessories; a mesh networking stack conforming to the Thread 1.1 specification; a small-footprint Bluetooth low energy system-in-package (SiP) module with a built-in chip antenna; a complete sensor-to-cloud Thunderboard kit that simplifies development of cloud-connected devices for the IoT; Wireless Gecko modules focused on mesh networking applications; a major update to our Simplicity Studio software development tools for IoT connected device applications; a CMOS-based family of isolated field effect transistor (FET) drivers; isolated gate drivers designed to protect power inverter and motor drive applications; high-speed, multi-channel programmable logic controller (PLC) isolators; a small, low-power USBXpress™ bridge device; multiband Wireless Gecko system-on-chip (SoC) devices enabling both 2.4 GHz and sub-GHz multiprotocol connectivity for the IoT market; a comprehensive reference design for cables and adapters based on the USB Type-C™ specification; jitter-attenuating clocks that simplify 100G/400G coherent optical line card and module design; a fully integrated, pre-certified Bluetooth module for low-energy applications; a family of isolated gate drivers for high-speed power supply designs; a plug-and-play Wi-Fi module solution for IoT applications; the scalable Blue Gecko wireless SoC family for the Bluetooth low-energy market; the Wireless Gecko portfolio of multiprotocol SoC devices for IoT applications; next-generation optical sensors that enable enhanced measurement of ultraviolet (UV) radiation and gesture recognition; and an optical heart rate sensing solution for wrist-based heart rate monitoring (HRM) applications. We plan to continue to introduce products that increase the content we provide for existing applications, thereby enabling us to serve markets we do not currently address and expand our total available market opportunity.

During fiscal 2016 and 2015, we had no end customer that represented more than 10% of our revenues. During fiscal 2014, we had one end customer, Samsung, whose purchases across a variety of product areas represented 12% of our revenues. In addition to direct sales to customers, some of our end customers purchase products indirectly from us through distributors and contract manufacturers. An end customer purchasing through a contract manufacturer typically instructs such contract manufacturer to obtain our products and incorporate such products with other components for sale by such contract manufacturer to the end customer. Although we actually sell the products to, and are paid by, the distributors and contract manufacturers, we refer to such end customer as our customer. Three of our distributors who sell to our customers, Edom Technology, Avnet and Arrow Electronics, each represented 17%, 13% and 11% of our revenues during fiscal 2016. Edom and Avnet represented 20% and 12% of our revenues during fiscal 2015, and 20% and 12% of our revenues during fiscal 2014, respectively. There were no other distributors or contract manufacturers that accounted for more than 10% of our revenues in fiscal 2016, 2015 or 2014.

The percentage of our revenues derived from outside of the United States was 86% in fiscal 2016, 85% in fiscal 2015 and 86% in fiscal 2014. Substantially all of our revenues to date have been denominated in U.S. dollars. We believe that a majority of our revenues will continue to be derived from customers outside of the United States.

The sales cycle for our ICs can be as long as 12 months or more. An additional three to six months or more are usually required before a customer ships a significant volume of devices that incorporate our ICs. Due to this lengthy sales cycle, we typically experience a significant delay between incurring research and development and selling, general and administrative expenses, and the corresponding sales. Consequently, if sales in any quarter do not occur when expected, expenses and inventory levels could be disproportionately high, and our operating results for that quarter and, potentially, future quarters would be adversely affected. Moreover, the amount of time between initial research and development and commercialization of a product, if ever, can be substantially longer than the sales cycle for the product. Accordingly, if we incur substantial research and development costs without developing a commercially successful product, our operating results, as well as our growth prospects, could be adversely affected.

Because many of our ICs are designed for use in consumer products such as televisions, set-top boxes, radios and wearables, we expect that the demand for our products will be typically subject to some degree of seasonal demand. However, rapid changes in our markets and across our product areas make it difficult for us to accurately estimate the impact of seasonal factors on our business.

Results of Operations

The following describes the line items set forth in our Consolidated Statements of Income:

Revenues. Revenues are generated predominately by sales of our products. We recognize revenue on sales when all of the following criteria are met: 1) there is persuasive evidence that an arrangement exists, 2) delivery of goods has occurred, 3) the sales price is fixed or determinable, and 4) collectibility is reasonably assured. Generally, we recognize revenue from product sales to direct customers and contract manufacturers upon shipment. Certain of our sales are made to distributors under agreements allowing certain rights of return and price protection on products unsold by distributors. Accordingly, we defer the revenue and cost of revenue on such sales until the distributors sell the product to the end customer. A small portion of our revenues is derived from the sale of patents. The above revenue recognition criteria for patent sales are generally met upon the execution of the patent sale agreement. Our products typically carry a one-year replacement warranty. Replacements have been insignificant to date.

Our revenues are subject to variation from period to period due to the volume of shipments made within a period, the mix of products we sell and the prices we charge for our products. The vast majority of our revenues were negotiated at prices that reflect a discount from the list prices for our products. These discounts are made for a variety of reasons, including: 1) to establish a relationship with a new customer, 2) as an incentive for customers to purchase products in larger volumes, 3) to provide profit margin to our distributors who resell our products or 4) in response to competition. In addition, as a product matures, we expect that the average selling price for such product will decline due to the greater availability of competing products. Our ability to increase revenues in the future is dependent on increased demand for our established products and our ability to ship larger volumes of those products in response to such demand, as well as our ability to develop or acquire new products and subsequently achieve customer acceptance of newly introduced products.

Cost of Revenues. Cost of revenues includes the cost of purchasing finished silicon wafers processed by independent foundries; costs associated with assembly, test and shipping of those products; costs of personnel and equipment associated with manufacturing support, logistics and quality assurance; costs of software royalties, other intellectual property license costs and certain acquired

intangible assets; and an allocated portion of our occupancy costs. Our gross margin as a percentage of revenue fluctuates depending on product mix, manufacturing yields, inventory valuation adjustments, average selling prices and other factors.

Research and Development. Research and development expense consists primarily of personnel-related expenses, including stock-based compensation, as well as new product masks, external consulting and services costs, equipment tooling, equipment depreciation, amortization of intangible assets, and an allocated portion of our occupancy costs. Research and development activities include the design of new products, refinement of existing products and design of test methodologies to ensure compliance with required specifications.

Selling, General and Administrative. Selling, general and administrative expense consists primarily of personnel-related expenses, including stock-based compensation, as well as an allocated portion of our occupancy costs, sales commissions to independent sales representatives, applications engineering support, professional fees, legal fees and promotional and marketing expenses.

Interest Income. Interest income reflects interest earned on our cash, cash equivalents and investment balances.

Interest Expense. Interest expense consists of interest on our short and long-term obligations, including our credit facilities.

Other, Net. Other, net consists primarily of foreign currency remeasurement adjustments as well as other non-operating income and expenses.

Provision for Income Taxes. Provision for income taxes includes both domestic and foreign income taxes at the applicable tax rates adjusted for non-deductible expenses, research and development tax credits and other permanent differences.

The following table sets forth our Consolidated Statements of Income data as a percentage of revenues for the periods indicated:

	<u>Fiscal Year</u>		
	<u>2016</u>	<u>2015</u>	<u>2014</u>
Revenues	100.0%	100.0%	100.0%
Cost of revenues	39.6	40.9	39.0
Gross margin	60.4	59.1	61.0
Operating expenses:			
Research and development	28.6	29.2	27.9
Selling, general and administrative	22.3	24.9	24.8
Operating expenses	50.9	54.1	52.7
Operating income	9.5	5.0	8.3
Other income (expense):			
Interest income	0.2	0.1	0.2
Interest expense	(0.4)	(0.4)	(0.6)
Other, net	(0.1)	0.0	0.0
Income before income taxes	9.2	4.7	7.9
Provision for income taxes	0.4	0.1	1.8
Net income	<u>8.8%</u>	<u>4.6%</u>	<u>6.1%</u>

Comparison of Fiscal 2016 to Fiscal 2015

Revenues

<u>(in millions)</u>	<u>Fiscal Year</u>		<u>Change</u>	<u>% Change</u>
	<u>2016</u>	<u>2015</u>		
Internet of Things	\$314.6	\$262.3	\$ 52.3	19.9%
Broadcast	157.7	161.8	(4.1)	(2.5)%
Infrastructure	147.7	122.0	25.7	21.1%
Access	77.6	98.7	(21.1)	(21.4)%
Revenues	\$697.6	\$644.8	\$ 52.8	8.2%

The change in revenues in fiscal 2016 was due primarily to:

- Increased revenues of \$52.3 million for our Internet of Things products, due primarily to increases in the market and the addition of revenues from acquisitions.
- Decreased revenues of \$4.1 million for Broadcast products, due primarily to decreases in the market for our consumer products.
- Increased revenues of \$25.7 million for our Infrastructure products, due primarily to increased demand for our products and the sale of patents for \$5.0 million.
- Decreased revenues of \$21.1 million for our Access products, due primarily to decreased demand for our products and decreases in the market for such products.

Unit volumes of our products increased by 14.6% and average selling prices decreased by 6.2% compared to fiscal 2015. The average selling prices of our products may fluctuate significantly from period to period. In general, as our products become more mature, we expect to experience decreases in average selling prices. We anticipate that newly announced, higher priced, next generation products and product derivatives will offset some of these decreases.

Gross Margin

<u>(in millions)</u>	<u>Fiscal Year</u>		<u>Change</u>
	<u>2016</u>	<u>2015</u>	
Gross margin	\$421.5	\$380.8	\$40.7
Percent of revenue	60.4%	59.1%	1.3%

The increased dollar amount of gross margin in fiscal 2016 was due to increases in gross margin of \$27.9 million for our Internet of Things products and \$21.7 million for our Infrastructure products, offset by decreases in gross margin of \$7.1 million for our Access products and \$1.8 million for our Broadcast products. Gross margin in fiscal 2016 included \$5.0 million from the sale of patents, which had no associated cost of revenues. Gross margin in fiscal 2015 included \$2.6 million in acquisition-related charges for the fair value write-up associated with inventory acquired from Bluegiga and Telegesis.

We may experience declines in the average selling prices of certain of our products. This creates downward pressure on gross margin as a percentage of revenues and may be offset to the extent we are able to: 1) introduce higher margin new products and gain market share with our products; 2) reduce costs of existing products through improved design; 3) achieve lower production costs from our wafer suppliers and third-party assembly and test subcontractors; 4) achieve lower production costs per unit as a result of improved yields throughout the manufacturing process; or 5) reduce logistics costs.

Research and Development

<u>(in millions)</u>	<u>Fiscal Year</u>		<u>Change</u>	<u>% Change</u>
	<u>2016</u>	<u>2015</u>		
Research and development	\$199.7	\$188.1	\$11.6	6.2%
Percent of revenue	28.6%	29.2%		

The increase in research and development expense in fiscal 2016 was primarily due to increases of (a) \$5.9 million for personnel-related expenses, including costs associated with increased headcount, and (b) \$4.4 million for new product introduction costs. We expect that research and development expense will increase in absolute dollars in the first quarter of 2017.

Selling, General and Administrative

<u>(in millions)</u>	<u>Fiscal Year</u>		<u>Change</u>	<u>% Change</u>
	<u>2016</u>	<u>2015</u>		
Selling, general and administrative	\$155.5	\$160.5	\$(5.0)	(3.1)%
Percent of revenue	22.3%	24.9%		

The decrease in selling, general and administrative expense in fiscal 2016 was primarily due to decreases of (a) \$2.1 million for adjustments to the fair value of acquisition-related contingent consideration, (b) \$1.3 million for personnel-related expenses, (c) \$1.0 million for acquisition-related costs, and (d) \$1.0 million for legal fees, primarily related to litigation. We expect that selling, general and administrative expense will remain relatively stable in absolute dollars in the first quarter of 2017.

Interest Income

Interest income in fiscal 2016 was \$1.3 million compared to \$0.7 million in fiscal 2015.

Interest Expense

Interest expense in fiscal 2016 was \$2.6 million compared \$2.8 million in fiscal 2015.

Other, Net

Other, net in fiscal 2016 was \$(0.5) million compared to \$0.1 million in fiscal 2015.

Provision for Income Taxes

<u>(in millions)</u>	<u>Fiscal Year</u>		<u>Change</u>
	<u>2016</u>	<u>2015</u>	
Provision for income taxes	\$3.0	\$0.7	\$2.3
Effective tax rate	4.7%	2.2%	

The effective tax rate for fiscal 2016 increased from fiscal 2015 primarily due to fiscal 2015 including a net benefit resulting from a change in the tax accounting treatment of stock-based compensation in a cost-sharing arrangement following a U.S. Tax Court case (Altera). The increase in the effective tax rate was partially offset by a reduction in the prior period valuation allowance. See Note 16, *Income Taxes*, to the Consolidated Financial Statements for additional information.

The effective tax rates for each of the periods presented differ from the federal statutory rate of 35% due to the amount of income earned in foreign jurisdictions where the tax rate may be lower than the federal statutory rate and other permanent items including nondeductible compensation expenses and research and development tax credits.

Comparison of Fiscal 2015 to Fiscal 2014

Revenues

<u>(in millions)</u>	<u>Fiscal Year</u>		<u>Change</u>	<u>% Change</u>
	<u>2015</u>	<u>2014</u>		
Internet of Things	\$262.3	\$209.0	\$ 53.3	25.5%
Broadcast	161.8	204.3	(42.5)	(20.8)%
Infrastructure	122.0	108.1	13.9	12.8%
Access	98.7	99.3	(0.6)	(0.6)%
Revenues	\$644.8	\$620.7	\$ 24.1	3.9%

The change in revenues in fiscal 2015 was due primarily to:

- Increased revenues of \$53.3 million for our Internet of Things products, due primarily to market share gains for our products, increases in the market and the addition of revenues from acquisitions.
- Decreased revenues of \$42.5 million for Broadcast products, due primarily to decreases in our market share and the market for our consumer products and the sale of patents for \$7.1 million in the fiscal 2014. The decrease in Broadcast revenues was offset by increased revenues for our automotive products due to increases in market share.
- Increased revenues of \$13.9 million for our Infrastructure products, due primarily to market share gains.
- Decreased revenues of \$0.6 million for our Access products.

Unit volumes of our products increased by 3.4% and average selling prices increased by 1.7% compared to fiscal 2014.

Gross Margin

<u>(in millions)</u>	<u>Fiscal Year</u>		<u>Change</u>
	<u>2015</u>	<u>2014</u>	
Gross margin	\$380.8	\$378.6	\$ 2.2
Percent of revenue	59.1%	61.0%	(1.9)%

The increased dollar amount of gross margin in fiscal 2015 was due to increases in gross margin of \$18.8 million for our Internet of Things products, \$8.1 million for our Infrastructure products and \$0.6 million for our Access products, offset by a decrease in gross margin of \$25.3 million for our Broadcast products. Gross margin in fiscal 2015 included \$2.6 million in acquisition-related charges for the fair value write-up associated with inventory acquired from Bluegiga and Telegesis. Gross margin in fiscal 2014 included \$7.1 million from the sale of patents, which had no associated cost of revenues.

Research and Development

<u>(in millions)</u>	<u>Fiscal Year</u>		<u>Change</u>	<u>% Change</u>
	<u>2015</u>	<u>2014</u>		
Research and development	\$188.1	\$173.0	\$15.1	8.7%
Percent of revenue	29.2%	27.9%		

The increase in research and development expense in fiscal 2015 was primarily due to increases of (a) \$9.7 million for personnel-related expenses, including costs associated with increased headcount, and (b) \$6.7 million for the amortization of intangible assets.

Selling, General and Administrative

<u>(in millions)</u>	<u>Fiscal Year</u>		<u>Change</u>	<u>% Change</u>
	<u>2015</u>	<u>2014</u>		
Selling, general and administrative	\$160.5	\$154.1	\$6.4	4.1%
Percent of revenue	24.9%	24.8%		

The increase in selling, general and administrative expense in fiscal 2015 was primarily due to increases of (a) \$10.8 million for personnel-related expenses, including costs associated with increased headcount, (b) \$1.9 million for the amortization of intangible assets, (c) \$1.6 million for acquisition-related costs, and (d) \$1.0 million for product marketing costs. The increase in selling, general and administrative expense was offset in part by decreases of (a) \$6.3 million for legal fees, primarily related to litigation, and (b) \$5.2 million for adjustments to the fair value of acquisition-related contingent consideration.

Interest Income

Interest income in fiscal 2015 was \$0.7 million compared to \$1.0 million in fiscal 2014.

Interest Expense

Interest expense in fiscal 2015 was \$2.8 million compared \$3.2 million in fiscal 2014.

Other, Net

Other, net in fiscal 2015 was \$0.1 million compared to \$(0.2) million in fiscal 2014.

Provision for Income Taxes

<u>(in millions)</u>	<u>Fiscal Year</u>		<u>Change</u>
	<u>2015</u>	<u>2014</u>	
Provision for income taxes	\$0.7	\$11.0	\$(10.3)
Effective tax rate	2.2%	22.5%	

The effective tax rate for fiscal 2015 decreased from fiscal 2014, primarily due to the completion of payments related to a prior year intercompany licensing arrangement resulting in an increase to the foreign tax rate benefit as well as the recognition of a net benefit resulting from a change in the tax accounting treatment of stock-based compensation in a cost-sharing arrangement following a U.S. Tax Court case (Altera). See Note 16, *Income Taxes*, to the Consolidated Financial Statements for additional information.

The decrease in the effective tax rate from the completion of payments related to a prior year intercompany licensing arrangement and the recognition of a net benefit from the Altera case, was partially offset by an increase in the prior year valuation allowance related to lower expectations of profitability in jurisdictions where tax attributes exist.

The effective tax rates for each of the periods presented differ from the federal statutory rate of 35% due to the amount of income earned in foreign jurisdictions where the tax rate may be lower than the federal statutory rate and other permanent items including nondeductible compensation expenses and research and development tax credits.

Business Outlook

We expect revenues in the first quarter of fiscal 2017 to be in the range of \$174 to \$179 million. Furthermore, we expect our diluted earnings per share to be in the range of \$0.21 to \$0.27.

Liquidity and Capital Resources

Our principal sources of liquidity as of December 31, 2016 consisted of \$295.1 million in cash, cash equivalents and short-term investments, of which approximately \$193.8 million was held by our U.S. entities. The remaining balance was held by our foreign subsidiaries. Our cash equivalents and short-term investments consisted of municipal bonds, money market funds, corporate bonds, variable-rate demand notes, U.S. government bonds, asset-back securities, certificates of deposit, commercial paper and international government bonds. Our long-term investments consisted of auction-rate securities. As of December 31, 2016, we held \$6.0 million par value auction-rate securities, all of which have experienced failed auctions because sell orders exceeded buy orders. See Note 4, *Fair Value of Financial Instruments*, to the Consolidated Financial Statements for additional information.

Operating Activities

Net cash provided by operating activities was \$128.9 million during fiscal 2016, compared to net cash provided of \$105.4 million during fiscal 2015. Operating cash flows during fiscal 2016 reflect our net income of \$61.5 million, adjustments of \$74.8 million for depreciation, amortization, stock-based compensation and deferred income taxes, and a net cash outflow of \$7.4 million due to changes in our operating assets and liabilities.

Net cash provided by operating activities was \$105.4 million during fiscal 2015, compared to net cash provided of \$137.4 million during fiscal 2014. Operating cash flows during fiscal 2015 reflect our net income of \$29.6 million, adjustments of \$80.2 million for depreciation, amortization, stock-based compensation and deferred income taxes, and a net cash outflow of \$4.4 million due to changes in our operating assets and liabilities.

Accounts receivable increased to \$74.4 million at December 31, 2016 from \$73.6 million at January 2, 2016. The increase in accounts receivable resulted primarily from normal variations in the timing of collections and billings. Our average DSO was 37 days at December 31, 2016 and 41 days at January 2, 2016.

Inventory increased to \$59.6 million at December 31, 2016 from \$53.9 million at January 2, 2016. Our inventory level is primarily impacted by our need to make purchase commitments to support forecasted demand and variations between forecasted and actual demand. Our DOI was 73 days at December 31, 2016 and January 2, 2016.

Investing Activities

Net cash used in investing activities was \$49.6 million during fiscal 2016, compared to net cash used of \$49.3 million during fiscal 2015. The increase in cash outflows was principally due to an increase of \$87.8 million in net purchases of marketable securities and an increase of \$2.4 million for the purchase of other assets, offset by a decrease of \$89.6 million in net payments for the acquisition of businesses. See Note 8, *Acquisitions*, to the Consolidated Financial Statements for additional information.

Net cash used in investing activities was \$49.3 million during fiscal 2015, compared to net cash used of \$26.3 million during fiscal 2014. The increase in cash outflows was principally due to \$96.1 million in net payments for the acquisition of businesses, including \$76.1 million for the purchase of Bluegiga and Telegesis and \$20.0 million for consideration previously withheld in connection with our purchase of Energy Micro, offset by an increase of \$74.0 million from net proceeds from the sales and maturities of marketable securities.

We anticipate capital expenditures of approximately \$18 to \$22 million for fiscal 2017. Additionally, as part of our growth strategy, we expect to evaluate opportunities to invest in or acquire other

businesses, intellectual property or technologies that would complement or expand our current offerings, expand the breadth of our markets or enhance our technical capabilities.

Financing Activities

Net cash used in financing activities was \$52.3 million during fiscal 2016, compared to net cash used of \$83.8 million during fiscal 2015. The decrease in cash outflows was principally due to a decrease of \$89.7 million in payments on debt and a decrease of \$30.9 million for repurchases of our common stock, offset by \$81.2 million in net proceeds from the issuance of long-term debt during fiscal 2015 and an increase of \$5.0 million for payments of acquisition-related contingent consideration. In July 2015, we amended our Credit Agreement. In August 2015, the Board of Directors authorized a program to repurchase up to \$100 million of our common stock through December 2016. In January 2017, the Board of Directors authorized a program to repurchase up to \$100 million of our common stock through December 2017.

Net cash used in financing activities was \$83.8 million during fiscal 2015, compared to net cash used of \$65.2 million during fiscal 2014. The increase in cash outflows was principally due to an increase of \$87.2 million in payments on debt and a decrease of \$10.2 million from proceeds from the issuance of common stock, net of cash paid for withheld taxes, offset by net proceeds of \$81.2 million from the issuance of long-term debt.

Debt

On July 31, 2012, we entered into a \$230 million five-year Credit Agreement (the “Credit Agreement”), which consisted of a \$100 million Term Loan Facility and a \$130 million Revolving Credit Facility (collectively, the “Credit Facilities”). On July 24, 2015, we amended the Credit Agreement (the “Amended Credit Agreement”) in order to, among other things, increase the borrowing capacity under the Revolving Credit Facility to \$300 million, eliminate the Term Loan Facility and extend the maturity date to five years from the closing date. On July 24, 2015, we borrowed \$82.5 million under the Amended Credit Agreement and paid off the remaining balance of our Term Loan Facility.

The Amended Credit Agreement includes a \$25 million letter of credit sublimit and a \$10 million swingline loan sublimit. We also have an option to increase the size of the borrowing capacity by up to an aggregate of \$200 million in additional commitments, subject to certain conditions. See Note 10, *Debt*, to the Consolidated Financial Statements for additional information.

Our future capital requirements will depend on many factors, including the rate of sales growth, market acceptance of our products, the timing and extent of research and development projects, potential acquisitions of companies or technologies and the expansion of our sales and marketing activities. We believe our existing cash, cash equivalents, investments and credit under our Credit Facilities are sufficient to meet our capital requirements through at least the next 12 months, although we could be required, or could elect, to seek additional funding prior to that time. We may enter into acquisitions or strategic arrangements in the future which also could require us to seek additional equity or debt financing.

Contractual Obligations

The following table summarizes our contractual obligations as of December 31, 2016 (in thousands):

	Payments due by period						
	Total	2017	2018	2019	2020	2021	Thereafter
Long-term debt obligations (1) . . .	\$72,500	\$ —	\$ —	\$ —	\$72,500	\$ —	\$ —
Interest on long-term debt obligations (2)	\$ 7,873	\$ 2,201	\$2,219	\$2,207	\$ 1,246	\$ —	\$ —
Operating lease obligations (3) . . .	\$21,047	\$ 5,139	\$3,852	\$2,700	\$ 2,432	\$2,286	\$4,638
Purchase obligations (4)	\$44,613	\$44,613	\$ —	\$ —	\$ —	\$ —	\$ —
Other long-term obligations (5) . . .	\$15,108	\$ —	\$4,976	\$5,468	\$ 4,664	\$ —	\$ —

- (1) Long-term debt obligations represent the principal portion of our Credit Facilities.
- (2) Interest on our long-term debt obligations is based on the Eurodollar Base Rate plus an applicable margin. We have entered into an interest rate swap agreement as a hedge against the Eurodollar portion of such variable interest payments and effectively converted the Eurodollar portion of the interest on the Credit Facilities to a fixed interest rate through July 2020. As of December 31, 2016, the combined interest rate on the Credit Facilities and the interest rate swap was 2.375%. The impact of the interest rate swap was factored into the calculation of the future interest payments on our long-term debt obligations through July 2020.
- (3) Operating lease obligations include amounts for leased facilities.
- (4) Purchase obligations include contractual arrangements in the form of purchase orders with suppliers where there is a fixed non-cancelable payment schedule or minimum payments due with a reduced delivery schedule.
- (5) Other long-term obligations primarily represent software license obligations.

We are unable to make a reasonably reliable estimate as to when or if cash settlement with taxing authorities will occur for our unrecognized tax benefits. Therefore, our liability of \$3.1 million for unrecognized tax benefits is not included in the table above. See Note 16, *Income Taxes*, to the Consolidated Financial Statements for additional information.

Off-Balance Sheet Arrangements

As of December 31, 2016, we had no significant off-balance sheet arrangements.

Critical Accounting Policies and Estimates

The preparation of financial statements and accompanying notes in conformity with U.S. generally accepted accounting principles requires that we make estimates and assumptions that affect the amounts reported. Changes in facts and circumstances could have a significant impact on the resulting estimated amounts included in the financial statements. We believe the following critical accounting policies affect our more complex judgments and estimates. We also have other policies that we consider to be key accounting policies, such as our policies for revenue recognition, including the deferral of revenues and cost of revenues on sales to distributors; however, these policies do not meet the definition of critical accounting estimates because they do not generally require us to make estimates or judgments that are difficult or subjective.

Inventory valuation—We assess the recoverability of inventories through the application of a set of methods, assumptions and estimates. In determining net realizable value, we write down inventory that

may be slow moving or have some form of obsolescence, including inventory that has aged more than 12 months. We also adjust the valuation of inventory when its manufacturing cost exceeds the estimated market value less selling costs. We assess the potential for any unusual customer returns based on known quality or business issues and write-off inventory losses for scrap or non-saleable material. Inventory not otherwise identified to be written down is compared to an assessment of our 12-month forecasted demand. The result of this methodology is compared against the product life cycle and competitive situations in the marketplace to determine the appropriateness of the resulting inventory levels. Demand for our products may fluctuate significantly over time, and actual demand and market conditions may be more or less favorable than those that we project. In the event that actual demand is lower or market conditions are worse than originally projected, additional inventory write-downs may be required.

Stock-based compensation—We recognize the fair-value of stock-based compensation transactions in the Consolidated Statements of Income. The fair value of our full-value stock awards (with the exception of market-based performance awards) equals the fair market value of our stock on the date of grant. The fair value of our market-based performance awards is estimated at the date of grant using a Monte-Carlo simulation. The fair value of our stock option and employee stock purchase plan grants is estimated at the date of grant using the Black-Scholes option pricing model. In addition, we are required to estimate the expected forfeiture rate of our stock grants and only recognize the expense for those shares expected to vest. If our actual experience differs significantly from the assumptions used to compute our stock-based compensation cost, or if different assumptions had been used, we may have recorded too much or too little stock-based compensation cost. See Note 12, *Stock-Based Compensation*, to the Consolidated Financial Statements for additional information.

Investments in auction-rate securities—We determine the fair value of our investments in auction-rate securities using a discounted cash flow model. The assumptions used in preparing the discounted cash flow model include estimates for interest rates, amount of cash flows, expected holding periods of the securities and a discount to reflect our inability to liquidate the securities. For available-for-sale auction-rate securities, if the calculated value is below the carrying amount of the securities, we then determine if the decline in value is other-than-temporary. We consider various factors in determining whether an impairment is other-than-temporary, including the severity and duration of the impairment, changes in underlying credit ratings, forecasted recovery, our intent to sell or the likelihood that we would be required to sell the investment before its anticipated recovery in market value and the probability that the scheduled cash payments will continue to be made. When we conclude that an other-than-temporary impairment has occurred, we assess whether we intend to sell the security or if it is more likely than not that we will be required to sell the security before recovery. If either of these two conditions is met, we recognize a charge in earnings equal to the entire difference between the security's amortized cost basis and its fair value. If we do not intend to sell a security and it is not more likely than not that we will be required to sell the security before recovery, the unrealized loss is separated into an amount representing the credit loss, which is recognized in earnings, and the amount related to all other factors, which is recorded in accumulated other comprehensive income (loss).

Acquired intangible assets—When we acquire a business, a portion of the purchase price is typically allocated to identifiable intangible assets, such as acquired technology and customer relationships. Fair value of these assets is determined primarily using the income approach, which requires us to project future cash flows and apply an appropriate discount rate. We amortize intangible assets with finite lives over their expected useful lives. Our estimates are based upon assumptions believed to be reasonable but which are inherently uncertain and unpredictable. Assumptions may be incomplete or inaccurate, and unanticipated events and circumstances may occur. Incorrect estimates could result in future impairment charges, and those charges could be material to our results of operations.

Impairment of goodwill and other long-lived assets—We review long-lived assets which are held and used, including fixed assets and purchased intangible assets, for impairment whenever changes in circumstances indicate that the carrying amount of the assets may not be recoverable. Such evaluations compare the carrying amount of an asset to future undiscounted net cash flows expected to be generated by the asset over its expected useful life and are significantly impacted by estimates of future prices and volumes for our products, capital needs, economic trends and other factors which are inherently difficult to forecast. If the asset is considered to be impaired, we record an impairment charge equal to the amount by which the carrying value of the asset exceeds its fair value determined by either a quoted market price, if any, or a value determined by utilizing a discounted cash flow technique.

We test our goodwill for impairment annually as of the first day of our fourth fiscal quarter and in interim periods if certain events occur indicating that the carrying value of goodwill may be impaired. The goodwill impairment test is a two-step process. The first step of the impairment analysis compares our fair value to our net book value. In determining fair value, the accounting guidance allows for the use of several valuation methodologies, although it states quoted market prices are the best evidence of fair value. If the fair value is less than the net book value, the second step of the analysis compares the implied fair value of our goodwill to its carrying amount. If the carrying amount of goodwill exceeds its implied fair value, we recognize an impairment loss equal to that excess amount.

Income taxes—We are required to calculate income taxes in each of the jurisdictions in which we operate. This process involves calculating the actual current tax liability together with assessing temporary differences in recognition of income (loss) for tax and accounting purposes. These differences result in deferred tax assets and liabilities, which are included in our Consolidated Balance Sheet. We record a valuation allowance when it is more likely than not that some portion or all of the deferred tax assets will not be realized. In assessing the need for a valuation allowance, we are required to estimate the amount of expected future taxable income. Judgment is inherent in this process and differences between the estimated and actual taxable income could result in a material impact on our Consolidated Financial Statements.

We recognize liabilities for uncertain tax positions based on a two-step process. The first step requires us to determine whether the weight of available evidence indicates that the tax position has met the threshold for recognition. Therefore, we must evaluate whether it is more likely than not that the position will be sustained on audit, including resolution of any related appeals or litigation processes. The second step requires us to measure the tax benefit of the tax position taken, or expected to be taken, in an income tax return as the largest amount that is more than 50% likely of being realized upon ultimate settlement. This measurement step is inherently complex and requires subjective estimations of such amounts to determine the probability of various possible outcomes. We re-evaluate the uncertain tax positions each quarter based on factors including, but not limited to, changes in facts or circumstances, changes in tax law, expirations of statutes of limitation, effectively settled issues under audit, and new audit activity. Such a change in recognition or measurement would result in the recognition of a tax benefit or an additional charge to the tax provision in the period.

Although we believe the measurement of our liabilities for uncertain tax positions is reasonable, no assurance can be given that the final outcome of these matters will not be different than what is reflected in the historical income tax provisions and accruals. If additional taxes are assessed as a result of an audit or litigation, it could have a material effect on our income tax provision and net income in the period or periods for which that determination is made. We operate within multiple taxing jurisdictions and are subject to audit in these jurisdictions. These audits can involve complex issues which may require an extended period of time to resolve and could result in additional assessments of income tax. We believe adequate provisions for income taxes have been made for all periods.

Recent Accounting Pronouncements

In January 2017, the Financial Accounting Standards Board (FASB) issued Accounting Standards Update (ASU) No. 2017-01, *Business Combinations (Topic 805): Clarifying the Definition of a Business*. This ASU clarifies the definition of a business with the objective of adding guidance to assist entities with evaluating whether transactions should be accounted for as acquisitions (or disposals) of assets or businesses. This ASU is effective for annual periods beginning after December 15, 2017, including interim periods within those periods. We are currently evaluating the effect that the adoption of this ASU will have on our financial statements.

In August 2016, the FASB issued ASU No. 2016-16, *Income Taxes (Topic 740): Intra-Entity Transfers of Assets Other Than Inventory*. This ASU requires the recognition of the income tax consequences of an intra-entity transfer of an asset other than inventory when the transfer occurs. This ASU is effective for annual reporting periods beginning after December 15, 2017, including interim reporting periods within those annual reporting periods, with early adoption permitted. The amendments in this ASU should be applied on a modified retrospective basis through a cumulative-effect adjustment directly to retained earnings as of the beginning of the period of adoption. We have elected to early adopt this ASU on January 1, 2017. We currently expect to record a cumulative-effect adjustment to decrease retained earnings by between \$0.0 and \$2.5 million with a corresponding adjustment to non-current assets and deferred taxes on the Consolidated Balance Sheet.

In August 2016, the FASB issued ASU No. 2016-15, *Statement of Cash Flows (Topic 230): Classification of Certain Cash Receipts and Cash Payments*. This ASU provides guidance on statement of cash flows presentation for eight specific cash flow issues where diversity in practice exists. This ASU is effective for fiscal years beginning after December 15, 2017, and interim periods within those fiscal years. We are currently evaluating the effect that the adoption of this ASU will have on our financial statements.

In June 2016, the FASB issued ASU No. 2016-13, *Financial Instruments—Credit Losses (Topic 326): Measurement of Credit Losses on Financial Instruments*. This ASU requires instruments measured at amortized cost to be presented at the net amount expected to be collected. Entities are also required to record allowances for available-for-sale debt securities rather than reduce the carrying amount. This ASU is effective for fiscal years beginning after December 15, 2019, including interim periods within those fiscal years. We are currently evaluating the effect that the adoption of this ASU will have on our financial statements.

In March 2016, the FASB issued ASU No. 2016-09, *Compensation—Stock Compensation (Topic 718): Improvements to Employee Share-Based Payment Accounting*. This ASU simplifies several aspects of the accounting for share-based payment transactions, including the income tax consequences, classification of awards as either equity or liabilities and classification on the statement of cash flows. This ASU is effective for annual periods beginning after December 15, 2016, and interim periods within those annual periods. We expect the primary impact of this ASU to be the income tax effects of awards recognized in the income statement when the awards are vested or settled.

In February 2016, the FASB issued ASU No. 2016-02, *Leases (Topic 842)*. The core principle of Topic 842 is that a lessee should recognize the assets and liabilities that arise from leases. For operating leases, a lessee is required to recognize a right-of-use asset and a lease liability, initially measured at the present value of the lease payments, in the statement of financial position. This ASU is effective for fiscal years beginning after December 15, 2018, including interim periods within those fiscal years. We are currently evaluating the effect that the adoption of this ASU will have on our financial statements.

In January 2016, the FASB issued ASU No. 2016-01, *Financial Instruments—Overall (Subtopic 825-10): Recognition and Measurement of Financial Assets and Financial Liabilities*. This ASU addresses certain aspects of recognition, measurement, presentation and disclosure of financial

instruments. This ASU is effective for fiscal years beginning after December 15, 2017, including interim periods within those fiscal years. We are currently evaluating the effect that the adoption of this ASU will have on our financial statements.

In July 2015, the FASB issued ASU No. 2015-11, *Inventory (Topic 330): Simplifying the Measurement of Inventory*. This ASU requires inventory to be measured at the lower of cost and net realizable value. Net realizable value is the estimated selling prices in the ordinary course of business, less reasonably predictable costs of completion, disposal, and transportation. This ASU is effective for fiscal years beginning after December 15, 2016, including interim periods within those fiscal years. We do not expect that the adoption of this ASU will have a material impact on our financial statements.

In May 2014, the FASB issued ASU No. 2014-09, *Revenue from Contracts with Customers (Topic 606)*, which supersedes the revenue recognition requirements in Accounting Standards Codification (ASC) 605, *Revenue Recognition*. The core principle of ASU 2014-09 is that an entity should recognize revenue to depict the transfer of promised goods or services to customers in an amount that reflects the consideration to which the entity expects to be entitled in exchange for those goods or services. The guidance provides a five-step process to achieve that core principle. In August 2015, the FASB issued ASU No. 2015-14, *Revenue from Contracts with Customers (Topic 606): Deferral of the Effective Date*, which deferred the effective date of ASU 2014-09 to annual reporting periods beginning after December 15, 2017, including interim periods within that reporting period. In 2016, the FASB issued the following amendments to ASC 606: ASU No. 2016-08, *Revenue from Contracts with Customers (Topic 606): Principal versus Agent Considerations (Reporting Revenue Gross versus Net)*, which clarifies the implementation guidance on principal versus agent considerations; ASU No. 2016-10, *Revenue from Contracts with Customers (Topic 606): Identifying Performance Obligations and Licensing*, which clarifies guidance on identification of performance obligations and licensing implementation; ASU No. 2016-12, *Compensation—Revenue from Contracts with Customers (Topic 606): Narrow-Scope Improvements and Practical Expedients*, which provides clarifying guidance on assessing collectibility, presentation of sales taxes, noncash consideration, contract modifications and completed contracts; and ASU No. 2016-20, *Technical Corrections and Improvements to Topic 606, Revenue from Contracts with Customers*, which clarifies narrow aspects of ASC 606 or corrects unintended application of the guidance. The standard may be applied retrospectively to each prior period presented (full retrospective method) or retrospectively with the cumulative effect recognized as of the date of initial application (modified retrospective method). Under the new standard, we expect the timing of revenue recognition from sales to distributors to be accelerated. We will recognize revenue at the time of sale to the distributor, net of the impact of estimated price adjustments and rights of return. We currently anticipate adopting this standard using the modified retrospective method. We are continuing to evaluate the effect that the adoption will have on our financial statements.

Item 7A. Quantitative and Qualitative Disclosures about Market Risk

Interest Income

Our investment portfolio includes cash, cash equivalents, short-term investments and long-term investments. Our main investment objectives are the preservation of investment capital and the maximization of after-tax returns on our investment portfolio. Our interest income is sensitive to changes in the general level of U.S. interest rates. Our investment portfolio holdings as of December 31, 2016 and January 2, 2016 yielded less than 100 basis points. A decline in yield to zero basis points on our investment portfolio holdings as of December 31, 2016 and January 2, 2016 would decrease our future annual interest income by approximately \$1.9 million and \$0.9 million, respectively. We believe that our investment policy, which defines the duration, concentration, and minimum credit quality of the allowable investments, meets our investment objectives.

Interest Expense

We are exposed to interest rate fluctuations in the normal course of our business, including through our Credit Facilities. The interest payments on the Credit Facilities consist of a variable-rate of interest and an applicable margin. We have entered into an interest rate swap agreement with an original notional value of \$72.5 million that, effectively, converted the variable-rate interest payments to fixed-rate interest payments through July 2020.

Foreign currency exchange rate risk

We are exposed to foreign currency exchange rate risk primarily through assets and liabilities of our subsidiaries denominated in currencies other than the U.S. dollar. Our foreign subsidiaries are considered to be extensions of the U.S. parent. The functional currency of the foreign subsidiaries is the U.S. dollar. Accordingly, gains and losses resulting from remeasuring transactions denominated in currencies other than U.S. dollars are recorded in other, net in the Consolidated Statements of Income. We use foreign currency forward contracts to manage exposure to foreign exchange risk. Gains and losses on foreign currency forward contracts are recognized in earnings in the same period as the remeasurement loss and gain of the related foreign currency denominated asset or liability.

Investments in Auction-rate Securities

As of December 31, 2016, we held \$6.0 million par value auction-rate securities, all of which have experienced failed auctions because sell orders exceeded buy orders. We are unable to predict if these funds will become available before their maturity dates. Additionally, if we determine that an other-than-temporary decline in the fair value of any of our available-for-sale auction-rate securities has occurred, we may be required to adjust the carrying value of the investments through an impairment charge.

Item 8. Financial Statements and Supplementary Data

The Financial Statements and supplementary data required by this item are included in Part IV, Item 15 of this Form 10-K and are presented beginning on page F-1.

Item 9. Changes in and Disagreements with Accountants on Accounting and Financial Disclosure

None.

Item 9A. Controls and Procedures

We have performed an evaluation under the supervision and with the participation of our management, including our Chief Executive Officer (CEO) and Chief Financial Officer (CFO), of the effectiveness of our disclosure controls and procedures, as defined in Rule 13a-15(e) under the Securities Exchange Act of 1934 (the Exchange Act). Based on that evaluation, our management, including our CEO and CFO, concluded that our disclosure controls and procedures were effective as of December 31, 2016 to provide reasonable assurance that information required to be disclosed by us in the reports filed or submitted by us under the Exchange Act is recorded, processed, summarized and reported within the time periods specified in the SEC's rules and forms. Such disclosure controls and procedures include controls and procedures designed to ensure that information required to be disclosed is accumulated and communicated to our management, including our CEO and CFO, to allow timely decisions regarding required disclosures. There was no change in our internal controls during the fiscal quarter ended December 31, 2016 that materially affected, or is reasonably likely to materially affect, our internal controls over financial reporting.

Management's Report on Internal Control over Financial Reporting

Our management is responsible for establishing and maintaining adequate internal control over financial reporting. Our internal control system was designed to provide reasonable assurance to our management and Board of Directors regarding the preparation and fair presentation of published financial statements.

Our management assessed the effectiveness of our internal control over financial reporting as of December 31, 2016. In making this assessment, it used the criteria set forth by the Committee of Sponsoring Organizations of the Treadway Commission (COSO) in *Internal Control—Integrated Framework* (2013 framework). Based on our assessment we concluded that, as of December 31, 2016, our internal control over financial reporting is effective based on those criteria.

Our independent registered public accounting firm, Ernst & Young LLP, issued an attestation report on our internal control over financial reporting. This report appears on page F-1.

Item 9B. Other Information

None.

Part III

Certain information required by Part III is omitted from this report because we intend to file a definitive Proxy Statement pursuant to Regulation 14A (the “Proxy Statement”) no later than 120 days after the end of the fiscal year covered by this report, and certain information to be included therein is incorporated herein by reference.

Item 10. Directors, Executive Officers and Corporate Governance

The information required by this Item is incorporated by reference to the Proxy Statement under the sections captioned “Proposal One: Election of Directors,” “Executive Compensation,” “Section 16(a) Beneficial Ownership Reporting Compliance” and “Code of Ethics.”

Item 11. Executive Compensation

The information under the caption “Executive Compensation” and “Proposal One: Election of Directors” appearing in the Proxy Statement, is incorporated herein by reference.

Item 12. Security Ownership of Certain Beneficial Owners and Management and Related Stockholder Matters

The information under the caption “Ownership of Securities” and “Equity Compensation Plan Information” appearing in the Proxy Statement is incorporated herein by reference.

Item 13. Certain Relationships and Related Transactions, and Director Independence

The information under the caption “Certain Relationships and Related Transactions, and Director Independence” appearing in the Proxy Statement is incorporated herein by reference.

Item 14. Principal Accounting Fees and Services

The information under the caption “Proposal Two: Ratification of Appointment of Independent Registered Public Accounting Firm” appearing in the Proxy Statement is incorporated herein by reference.

Part IV

Item 15. Exhibits and Financial Statement Schedules

(a) 1. Financial Statements

Index

	<u>Page</u>
Report of independent registered public accounting firm	F-1
Report of independent registered public accounting firm	F-2
Consolidated Balance Sheets at December 31, 2016 and January 2, 2016	F-3
Consolidated Statements of Income for the fiscal years ended December 31, 2016, January 2, 2016 and January 3, 2015	F-4
Consolidated Statements of Comprehensive Income for the fiscal years ended December 31, 2016, January 2, 2016 and January 3, 2015	F-5
Consolidated Statements of Changes in Stockholders' Equity for the fiscal years ended December 31, 2016, January 2, 2016 and January 3, 2015	F-6
Consolidated Statements of Cash Flows for the fiscal years ended December 31, 2016, January 2, 2016 and January 3, 2015	F-7
Notes to Consolidated Financial Statements	F-8

2. Schedules

Schedule II—Valuation and Qualifying Accounts

All other schedules have been omitted since the information required by the schedule is not applicable, or is not present in amounts sufficient to require submission of the schedule, or because the information required is included in the Consolidated Financial Statements and notes thereto.

3. Exhibits

The exhibits listed on the accompanying index to exhibits immediately following the Consolidated Financial Statements are filed as part of, or hereby incorporated by reference into, this Form 10-K.

(b) Exhibits

<u>Exhibit Number</u>	
2.1*	Sale and Purchase Agreement dated January 30, 2015, by and between Silicon Laboratories International Pte. Ltd. and the holders of shares, options and capital loans in Bluegiga Technologies Oy (filed as Exhibit 2.1 to the Form 8-K filed on February 4, 2015).
2.2*	Agreement dated November 20, 2015, by and between the shareholders of Telegesis (UK) Limited and Silicon Laboratories UK Limited (filed as Exhibit 2.1 to the Form 8-K filed on November 23, 2015).
3.1*	Form of Fourth Amended and Restated Certificate of Incorporation of Silicon Laboratories Inc. (filed as Exhibit 3.1 to the Registrant's Registration Statement on Form S-1 (Securities and Exchange Commission File No. 333-94853) (the "IPO Registration Statement")).
3.2*	Fourth Amended and Restated Bylaws of Silicon Laboratories Inc. (filed as Exhibit 3.2 to the Registrant's Current Report on Form 8-K filed on January 27, 2017).
4.1*	Specimen certificate for shares of common stock (filed as Exhibit 4.1 to the IPO Registration Statement).
10.1*+	Form of Indemnification Agreement between Silicon Laboratories Inc. and each of its directors and executive officers (filed as Exhibit 10.1 to the IPO Registration Statement).
10.2*	Credit Agreement, dated July 31, 2012, by and among Silicon Laboratories Inc., the subsidiaries of the borrower identified therein, Bank of America, N.A., Wells Fargo Bank, National Association, and Regions Bank (filed as Exhibit 10.1 to the Form 8-K filed August 1, 2012).
10.3*	First Amendment to Credit Agreement, dated July 24, 2015, by and among Silicon Laboratories Inc., the subsidiaries of the borrower identified therein, Wells Fargo Bank, National Association, Citibank, N.A., Regions Bank, Bank of America, N.A. and the lenders party thereto (filed as Exhibit 10.1 to the Registrant's Current Report on Form 8-K filed on July 29, 2015).
10.4*	Security and Pledge Agreement, dated July 31, 2012, by and among Silicon Laboratories Inc., with the other parties identified as "Obligors" (as defined therein) and such other parties that may become Obligors thereunder after the date thereof, and Bank of America, N.A (filed as Exhibit 10.2 to the Form 8-K filed August 1, 2012).
10.5*+	Silicon Laboratories Inc. 2009 Stock Incentive Plan, as amended and restated on April 15, 2014 (filed as Exhibit 10.1 to the Registrant's Current Report on Form 8-K filed on April 16, 2014).
10.6*+	Silicon Laboratories Inc. 2009 Employee Stock Purchase Plan, as amended and restated on April 15, 2014 (filed as Exhibit 10.2 to the Registrant's Current Report on Form 8-K filed on April 16, 2014).
10.7+	Form of Restricted Stock Units Grant Notice and Global Restricted Stock Units Award Agreement under Registrant's 2009 Stock Incentive Plan, as amended and restated.
10.8+	Form of Market Stock Units Grant Notice and Global Market Stock Units Award Agreement under Registrant's 2009 Stock Incentive Plan, as amended and restated.
10.9+	Form of Stock Option Grant Notice and Global Stock Option Award Agreement under Registrant's 2009 Stock Incentive Plan, as amended and restated.

Exhibit Number	
10.10+	Form of Performance Stock Units Grant Notice and Global PSU Award Agreement under Registrant's 2009 Stock Incentive Plan, as amended and restated.
10.11*+	Silicon Laboratories Inc. 2017 Bonus Plan (filed as Exhibit 10.1 to the Registrant's Current Report on Form 8-K filed on January 26, 2017).
10.12*+	Silicon Laboratories Inc. Form of Change in Control Agreement (filed as Exhibit 10.1 to the Registrant's Current Report on Form 8-K filed on October 25, 2016).
21	Subsidiaries of the Registrant.
23.1	Consent of Independent Registered Public Accounting Firm.
24	Power of Attorney (included on signature page to this Form 10-K).
31.1	Certification of the Principal Executive Officer, as required by Section 302 of the Sarbanes-Oxley Act of 2002.
31.2	Certification of the Principal Financial Officer, as required by Section 302 of the Sarbanes-Oxley Act of 2002.
32.1	Certification as required by Section 906 of the Sarbanes-Oxley Act of 2002.
101.INS	XBRL Instance Document
101.SCH	XBRL Taxonomy Extension Schema Document
101.CAL	XBRL Taxonomy Extension Calculation Linkbase Document
101.LAB	XBRL Taxonomy Extension Label Linkbase Document
101.PRE	XBRL Taxonomy Extension Presentation Linkbase Document
101.DEF	XBRL Taxonomy Extension Definition Linkbase Document

* Incorporated herein by reference to the indicated filing.

+ Management contract or compensatory plan or arrangement

SCHEDULE II

SILICON LABORATORIES INC.
VALUATION AND QUALIFYING ACCOUNTS

<u>Valuation Allowance for Deferred Tax Assets</u>	<u>Balance at Beginning of Period</u>	<u>Additions Charged to Expenses</u>	<u>Deductions</u>	<u>Balance at End of Period</u>
		(in thousands)		
Year ended December 31, 2016	\$10,264	\$2,715	\$(618)	\$12,361
Year ended January 2, 2016	\$ 3,455	\$6,895	\$ (86)	\$10,264
Year ended January 3, 2015	\$ 3,775	\$ —	\$(320)	\$ 3,455

<u>Name</u>	<u>Title</u>	<u>Date</u>
<hr/> /s/ NEIL KIM Neil Kim	Director	February 1, 2017
<hr/> /s/ JACK R. LAZAR Jack R. Lazar	Director	February 1, 2017
<hr/> /s/ NINA RICHARDSON Nina Richardson	Director	February 1, 2017
<hr/> /s/ SUMIT SADANA Sumit Sadana	Director	February 1, 2017
<hr/> /s/ WILLIAM P. WOOD William P. Wood	Director	February 1, 2017

Report of Independent Registered Public Accounting Firm

The Board of Directors and Stockholders of Silicon Laboratories Inc.

We have audited Silicon Laboratories Inc.'s internal control over financial reporting as of December 31, 2016, based on criteria established in Internal Control—Integrated Framework issued by the Committee of Sponsoring Organizations of the Treadway Commission (2013 framework) (the COSO criteria). Silicon Laboratories Inc.'s management is responsible for maintaining effective internal control over financial reporting, and for its assessment of the effectiveness of internal control over financial reporting included in the accompanying Management's Report on Internal Control over Financial Reporting. Our responsibility is to express an opinion on the company's internal control over financial reporting based on our audit.

We conducted our audit in accordance with the standards of the Public Company Accounting Oversight Board (United States). Those standards require that we plan and perform the audit to obtain reasonable assurance about whether effective internal control over financial reporting was maintained in all material respects. Our audit included obtaining an understanding of internal control over financial reporting, assessing the risk that a material weakness exists, testing and evaluating the design and operating effectiveness of internal control based on the assessed risk, and performing such other procedures as we considered necessary in the circumstances. We believe that our audit provides a reasonable basis for our opinion.

A company's internal control over financial reporting is a process designed to provide reasonable assurance regarding the reliability of financial reporting and the preparation of financial statements for external purposes in accordance with generally accepted accounting principles. A company's internal control over financial reporting includes those policies and procedures that (1) pertain to the maintenance of records that, in reasonable detail, accurately and fairly reflect the transactions and dispositions of the assets of the company; (2) provide reasonable assurance that transactions are recorded as necessary to permit preparation of financial statements in accordance with generally accepted accounting principles, and that receipts and expenditures of the company are being made only in accordance with authorizations of management and directors of the company; and (3) provide reasonable assurance regarding prevention or timely detection of unauthorized acquisition, use, or disposition of the company's assets that could have a material effect on the financial statements.

Because of its inherent limitations, internal control over financial reporting may not prevent or detect misstatements. Also, projections of any evaluation of effectiveness to future periods are subject to the risk that controls may become inadequate because of changes in conditions, or that the degree of compliance with the policies or procedures may deteriorate.

In our opinion, Silicon Laboratories Inc. maintained, in all material respects, effective internal control over financial reporting as of December 31, 2016, based on the COSO criteria.

We also have audited, in accordance with the standards of the Public Company Accounting Oversight Board (United States), the consolidated balance sheets of Silicon Laboratories Inc. as of December 31, 2016 and January 2, 2016, and the related consolidated statements of income, comprehensive income, changes in stockholders' equity and cash flows for each of the three fiscal years in the period ended December 31, 2016 of Silicon Laboratories Inc. and our report dated February 1, 2017 expressed an unqualified opinion thereon.

/s/ ERNST & YOUNG LLP

Austin, Texas
February 1, 2017

Report of Independent Registered Public Accounting Firm

The Board of Directors and Stockholders of Silicon Laboratories Inc.

We have audited the accompanying consolidated balance sheets of Silicon Laboratories Inc. as of December 31, 2016 and January 2, 2016, and the related consolidated statements of income, comprehensive income, changes in stockholders' equity and cash flows for each of the three fiscal years in the period ended December 31, 2016. Our audits also included the financial statement schedule listed in the Index at Item 15(a). These financial statements and schedule are the responsibility of the Company's management. Our responsibility is to express an opinion on these financial statements and schedule based on our audits.

We conducted our audits in accordance with the standards of the Public Company Accounting Oversight Board (United States). Those standards require that we plan and perform the audit to obtain reasonable assurance about whether the financial statements are free of material misstatement. An audit includes examining, on a test basis, evidence supporting the amounts and disclosures in the financial statements. An audit also includes assessing the accounting principles used and significant estimates made by management, as well as evaluating the overall financial statement presentation. We believe that our audits provide a reasonable basis for our opinion.

In our opinion, the financial statements referred to above present fairly, in all material respects, the consolidated financial position of Silicon Laboratories Inc. at December 31, 2016 and January 2, 2016, and the consolidated results of its operations and its cash flows for each of the three fiscal years in the period ended December 31, 2016, in conformity with U.S. generally accepted accounting principles. Also, in our opinion, the related financial statement schedule, when considered in relation to the basic financial statements taken as a whole, present fairly in all material respects the information set forth therein.

We also have audited, in accordance with the standards of the Public Company Accounting Oversight Board (United States), Silicon Laboratories Inc.'s internal control over financial reporting as of December 31, 2016, based on criteria established in Internal Control-Integrated Framework issued by the Committee of Sponsoring Organizations of the Treadway Commission (2013 framework) and our report dated February 1, 2017 expressed an unqualified opinion thereon.

/s/ ERNST & YOUNG LLP

Austin, Texas
February 1, 2017

Silicon Laboratories Inc.
Consolidated Balance Sheets
(In thousands, except per share data)

	<u>December 31,</u> <u>2016</u>	<u>January 2,</u> <u>2016</u>
Assets		
Current assets:		
Cash and cash equivalents	\$ 141,106	\$ 114,085
Short-term investments	153,961	128,901
Accounts receivable, net	74,401	73,601
Inventories	59,578	53,895
Prepaid expenses and other current assets	<u>61,805</u>	<u>52,658</u>
Total current assets	490,851	423,140
Long-term investments	5,196	7,126
Property and equipment, net	129,559	131,132
Goodwill	276,130	272,722
Other intangible assets, net	103,565	121,354
Other assets, net	<u>76,543</u>	<u>55,989</u>
Total assets	<u>\$1,081,844</u>	<u>\$1,011,463</u>
Liabilities and Stockholders' Equity		
Current liabilities:		
Accounts payable	\$ 39,577	\$ 42,127
Current portion of long-term debt	—	10,000
Accrued expenses	50,100	52,131
Deferred income on shipments to distributors	45,568	35,448
Income taxes	<u>4,450</u>	<u>2,615</u>
Total current liabilities	139,695	142,321
Long-term debt	72,500	67,500
Other non-current liabilities	<u>42,691</u>	<u>40,528</u>
Total liabilities	254,886	250,349
Commitments and contingencies		
Stockholders' equity:		
Preferred stock—\$0.0001 par value; 10,000 shares authorized; no shares issued and outstanding	—	—
Common stock—\$0.0001 par value; 250,000 shares authorized; 41,889 and 41,727 shares issued and outstanding at December 31, 2016 and January 2, 2016, respectively	4	4
Additional paid-in capital	24,463	13,868
Retained earnings	801,999	747,749
Accumulated other comprehensive income (loss)	<u>492</u>	<u>(507)</u>
Total stockholders' equity	<u>826,958</u>	<u>761,114</u>
Total liabilities and stockholders' equity	<u>\$1,081,844</u>	<u>\$1,011,463</u>

The accompanying notes are an integral part of these Consolidated Financial Statements.

Silicon Laboratories Inc.
Consolidated Statements of Income
(In thousands, except per share data)

	Year Ended		
	December 31, 2016	January 2, 2016	January 3, 2015
Revenues	\$697,626	\$644,826	\$620,704
Cost of revenues	<u>276,122</u>	<u>264,056</u>	<u>242,153</u>
Gross margin	421,504	380,770	378,551
Operating expenses:			
Research and development	199,744	188,050	172,985
Selling, general and administrative	<u>155,483</u>	<u>160,486</u>	<u>154,145</u>
Operating expenses	<u>355,227</u>	<u>348,536</u>	<u>327,130</u>
Operating income	66,277	32,234	51,421
Other income (expense):			
Interest income	1,291	730	1,007
Interest expense	(2,587)	(2,828)	(3,154)
Other, net	<u>(485)</u>	<u>127</u>	<u>(234)</u>
Income before income taxes	64,496	30,263	49,040
Provision for income taxes	<u>3,002</u>	<u>677</u>	<u>11,019</u>
Net income	<u>\$ 61,494</u>	<u>\$ 29,586</u>	<u>\$ 38,021</u>
Earnings per share:			
Basic	\$ 1.47	\$ 0.70	\$ 0.88
Diluted	\$ 1.45	\$ 0.69	\$ 0.87
Weighted-average common shares outstanding:			
Basic	41,713	42,309	42,970
Diluted	42,376	42,945	43,793

The accompanying notes are an integral part of these Consolidated Financial Statements.

Silicon Laboratories Inc.
Consolidated Statements of Comprehensive Income
(In thousands)

	Year Ended		
	December 31, 2016	January 2, 2016	January 3, 2015
Net income	\$61,494	\$29,586	\$38,021
Other comprehensive income (loss), before tax:			
Net changes to available-for-sale securities:			
Unrealized gains (losses) arising during the period.....	(179)	(425)	1,107
Reclassification for losses included in net income	—	10	—
Net changes to cash flow hedges:			
Unrealized gains (losses) arising during the period.....	1,466	(728)	(799)
Reclassification for losses included in net income	249	489	618
Other comprehensive income (loss), before tax	1,536	(654)	926
Provision (benefit) for income taxes.....	537	(229)	324
Other comprehensive income (loss)	999	(425)	602
Comprehensive income	<u>\$62,493</u>	<u>\$29,161</u>	<u>\$38,623</u>

The accompanying notes are an integral part of these Consolidated Financial Statements.

Silicon Laboratories Inc.
Consolidated Statements of Changes in Stockholders' Equity
(In thousands)

	Common Stock			Retained Earnings	Accumulated Other Comprehensive Income (Loss)	Total Stockholders' Equity
	Number of Shares	Par Value	Additional Paid-In Capital			
Balance as of December 28, 2013 . .	42,779	\$ 4	\$ 48,630	\$690,612	\$(684)	\$738,562
Net income	—	—	—	38,021	—	38,021
Other comprehensive income (loss)	—	—	—	—	602	602
Stock issuances, net of shares withheld for taxes	1,124	—	13,320	—	—	13,320
Income tax benefit (shortfall) from stock-based awards	—	—	120	—	—	120
Repurchases of common stock . .	(1,678)	—	(71,676)	—	—	(71,676)
Stock-based compensation	—	—	39,107	—	—	39,107
Balance as of January 3, 2015	42,225	4	29,501	728,633	(82)	758,056
Net income	—	—	—	29,586	—	29,586
Other comprehensive income (loss)	—	—	—	—	(425)	(425)
Stock issuances, net of shares withheld for taxes	1,152	—	3,128	—	—	3,128
Income tax benefit (shortfall) from stock-based awards	—	—	(613)	—	—	(613)
Repurchases of common stock . .	(1,650)	—	(60,978)	(10,470)	—	(71,448)
Stock-based compensation	—	—	42,830	—	—	42,830
Balance as of January 2, 2016	41,727	4	13,868	747,749	(507)	761,114
Net income	—	—	—	61,494	—	61,494
Other comprehensive income (loss)	—	—	—	—	999	999
Stock issuances, net of shares withheld for taxes	1,055	—	6,346	—	—	6,346
Income tax benefit (shortfall) from stock-based awards	—	—	(2,061)	—	—	(2,061)
Repurchases of common stock . .	(893)	—	(33,299)	(7,244)	—	(40,543)
Stock-based compensation	—	—	39,609	—	—	39,609
Balance as of December 31, 2016 . .	<u>41,889</u>	<u>\$ 4</u>	<u>\$ 24,463</u>	<u>\$801,999</u>	<u>\$ 492</u>	<u>\$826,958</u>

The accompanying notes are an integral part of these Consolidated Financial Statements.

Silicon Laboratories Inc.
Consolidated Statements of Cash Flows
(In thousands)

	Year Ended		
	December 31, 2016	January 2, 2016	January 3, 2015
Operating Activities			
Net income	\$ 61,494	\$ 29,586	\$ 38,021
Adjustments to reconcile net income to cash provided by operating activities:			
Depreciation of property and equipment	13,216	12,517	12,561
Amortization of other intangible assets and other assets	27,715	29,131	17,923
Stock-based compensation expense	39,628	42,791	39,067
Income tax benefit (shortfall) from stock-based awards	(1,099)	469	489
Excess income tax benefit from stock-based awards	(572)	(2,497)	(632)
Deferred income taxes	(4,087)	(2,136)	3,054
Changes in operating assets and liabilities:			
Accounts receivable	46	1,702	1,757
Inventories	(6,093)	2,093	(7,170)
Prepaid expenses and other assets	(3,568)	(870)	9,332
Accounts payable	263	6,662	11,475
Accrued expenses	5,919	1,682	27,671
Deferred income on shipments to distributors	9,713	(5,298)	7,809
Income taxes	(3,040)	776	(3,371)
Other non-current liabilities	(10,625)	(11,161)	(20,543)
Net cash provided by operating activities	128,910	105,447	137,443
Investing Activities			
Purchases of available-for-sale investments	(185,231)	(107,366)	(166,094)
Sales and maturities of available-for-sale investments	161,921	171,831	156,520
Purchases of property and equipment	(10,927)	(11,268)	(11,225)
Purchases of other assets	(8,801)	(6,399)	(5,514)
Acquisitions of businesses, net of cash acquired	(6,546)	(96,112)	—
Net cash used in investing activities	(49,584)	(49,314)	(26,313)
Financing Activities			
Proceeds from issuance of long-term debt, net	—	81,238	—
Payments on debt	(5,000)	(94,706)	(7,500)
Repurchases of common stock	(40,543)	(71,448)	(71,676)
Payment of taxes withheld for vested stock awards	(11,133)	(13,869)	(9,622)
Proceeds from the issuance of common stock	13,299	16,998	22,942
Excess income tax benefit from stock-based awards	572	2,497	632
Payment of acquisition-related contingent consideration	(9,500)	(4,464)	—
Net cash used in financing activities	(52,305)	(83,754)	(65,224)
Increase (decrease) in cash and cash equivalents	27,021	(27,621)	45,906
Cash and cash equivalents at beginning of period	114,085	141,706	95,800
Cash and cash equivalents at end of period	<u>\$ 141,106</u>	<u>\$ 114,085</u>	<u>\$ 141,706</u>
Supplemental Disclosure of Cash Flow Information:			
Interest paid	<u>\$ 2,222</u>	<u>\$ 2,470</u>	<u>\$ 2,950</u>
Income taxes paid	<u>\$ 11,185</u>	<u>\$ 2,157</u>	<u>\$ 11,587</u>
Supplemental Disclosure of Non-Cash Activity:			
Stock issued in business combination	<u>\$ 4,181</u>	<u>\$ —</u>	<u>\$ —</u>

The accompanying notes are an integral part of these Consolidated Financial Statements.

Silicon Laboratories Inc.
Notes to Consolidated Financial Statements
December 31, 2016

1. Description of Business

Silicon Laboratories Inc. (the “Company”), a Delaware corporation, is a provider of silicon, software and solutions for the Internet of Things (IoT), Internet infrastructure, industrial, consumer and automotive markets. Within the semiconductor industry, the Company is known as a “fables” company meaning that the integrated circuits (ICs) incorporated in its products are manufactured by third-party foundry semiconductor companies.

2. Significant Accounting Policies

Basis of Presentation and Principles of Consolidation

The Company prepares financial statements on a 52- or 53-week fiscal year that ends on the Saturday closest to December 31. Fiscal 2016 and 2015 had 52 weeks and ended on December 31, 2016 and January 2, 2016, respectively. Fiscal 2014 had 53 weeks with the extra week occurring in the fourth quarter of the year and ended on January 3, 2015. The accompanying Consolidated Financial Statements include the accounts of the Company and its wholly owned subsidiaries. All significant intercompany balances and transactions have been eliminated in consolidation.

Foreign Currency Transactions

The Company’s foreign subsidiaries are considered to be extensions of the U.S. Company. The functional currency of the foreign subsidiaries is the U.S. dollar. Accordingly, gains and losses resulting from remeasuring transactions denominated in currencies other than U.S. dollars are included in other, net in the Consolidated Statements of Income.

Use of Estimates

The preparation of financial statements in conformity with accounting principles generally accepted in the United States requires management to make estimates and assumptions that affect the amounts reported in the financial statements and accompanying notes. Among the significant estimates affecting the financial statements are those related to inventories, stock-based compensation, investments in auction-rate securities, acquired intangible assets, goodwill, long-lived assets and income taxes. Actual results could differ from those estimates, and such differences could be material to the financial statements.

Reclassifications

Certain reclassifications have been made to prior year financial statements to conform to current year presentation.

Fair Value of Financial Instruments

The fair values of the Company’s financial instruments are recorded using a hierarchical disclosure framework based upon the level of subjectivity of the inputs used in measuring assets and liabilities. The three levels are described below:

Level 1—Inputs are unadjusted, quoted prices in active markets for identical assets or liabilities at the measurement date.

Silicon Laboratories Inc.
Notes to Consolidated Financial Statements
December 31, 2016 (Continued)

2. Significant Accounting Policies (Continued)

Level 2—Inputs are inputs other than quoted prices included within Level 1 that are observable for the asset or liability, either directly or indirectly.

Level 3—Inputs are unobservable for the asset or liability and are developed based on the best information available in the circumstances, which might include the Company's own data.

Cash and Cash Equivalents

Cash and cash equivalents consist of cash deposits, certificates of deposit, money market funds and investments in debt securities with original maturities of ninety days or less when purchased.

Investments

The Company's investments typically have original maturities greater than ninety days as of the date of purchase and are classified as either available-for-sale or trading securities. Investments in available-for-sale securities are reported at fair value, with unrealized gains and losses, net of tax, recorded as a component of accumulated other comprehensive income (loss) in the Consolidated Balance Sheet. Investments in trading securities are reported at fair value, with both realized and unrealized gains and losses recorded in other, net in the Consolidated Statement of Income. Investments in which the Company has the ability and intent, if necessary, to liquidate in order to support its current operations (including those with contractual maturities greater than one year from the date of purchase) are classified as short-term.

The Company reviews its available-for-sale investments as of the end of each reporting period for other-than-temporary declines in fair value based on the specific identification method. The Company considers various factors in determining whether an impairment is other-than-temporary, including the severity and duration of the impairment, changes in underlying credit ratings, forecasted recovery, its intent to sell or the likelihood that it would be required to sell the investment before its anticipated recovery in market value and the probability that the scheduled cash payments will continue to be made. When the Company concludes that an other-than-temporary impairment has occurred, the Company assesses whether it intends to sell the security or if it is more likely than not that it will be required to sell the security before recovery. If either of these two conditions is met, the Company recognizes a charge in earnings equal to the entire difference between the security's amortized cost basis and its fair value. If the Company does not intend to sell a security and it is not more likely than not that it will be required to sell the security before recovery, the unrealized loss is separated into an amount representing the credit loss, which is recognized in earnings, and the amount related to all other factors, which is recorded in accumulated other comprehensive income (loss).

In addition, the Company has made equity investments in non-publicly traded companies that it accounts for under the cost method. The Company periodically reviews these investments for other-than-temporary declines in fair value based on the specific identification method and writes down investments to their fair values when it determines that an other-than-temporary decline has occurred. There were no impairment charges recognized on equity investments during any of the periods presented.

Silicon Laboratories Inc.
Notes to Consolidated Financial Statements
December 31, 2016 (Continued)

2. Significant Accounting Policies (Continued)

Derivative Financial Instruments

The Company uses derivative financial instruments to manage certain exposures to the variability of interest rates and foreign currency exchange rates. The Company's objective is to offset increases and decreases in expenses resulting from these exposures with gains and losses on the derivative contracts, thereby reducing volatility of earnings. The Company does not use derivative contracts for speculative or trading purposes. The Company recognizes derivatives, on a gross basis, in the Consolidated Balance Sheet at fair value. Cash flows from derivatives are classified according to the nature of the cash receipt or payment in the Consolidated Statement of Cash Flows.

The Company uses interest rate swap agreements to manage exposure to interest rate risks. The swap agreements are designated and qualify as cash flow hedges. The effective portion of the gain or loss on the interest rate swaps is recorded in accumulated other comprehensive income (loss) as a separate component of stockholders' equity and is subsequently recognized as interest expense in the Consolidated Statement of Income when the hedged exposure affects earnings.

The Company uses foreign currency forward contracts to manage exposure to foreign exchange risk. These instruments are used to reduce the earnings impact that exchange rate fluctuations have on non-U.S. dollar balance sheet exposures. The Company recognizes gains and losses on the foreign currency forward contracts in other, net in the Consolidated Statement of Income in the same period as the remeasurement loss and gain of the related foreign currency denominated asset or liability. The Company does not apply hedge accounting to its foreign currency derivative instruments.

Inventories

Inventories are stated at the lower of cost, determined using the first-in, first-out method, or market. The Company writes down the carrying value of inventory to net realizable value for estimated obsolescence or unmarketable inventory based upon assumptions about the age of inventory, future demand and market conditions. Inventory impairment charges establish a new cost basis for inventory and charges are not subsequently reversed to income even if circumstances later suggest that increased carrying amounts are recoverable.

Property and Equipment

Property and equipment are stated at cost, net of accumulated depreciation. Depreciation is computed using the straight-line method over the useful lives of the assets ranging from three to seven years. Leasehold improvements are depreciated over the contractual lease period or their useful life, whichever is shorter.

The Company owns the facilities it had previously leased for its headquarters in Austin, Texas. The buildings are located on land which is leased through 2099 from a third party. The rents for these ground leases were prepaid for the term of the leases by the previous lessee. The buildings and leasehold interest in ground leases are being depreciated on a straight-line basis over their estimated useful lives of 40 years and 86 years, respectively.

Silicon Laboratories Inc.
Notes to Consolidated Financial Statements
December 31, 2016 (Continued)

2. Significant Accounting Policies (Continued)

Business Combinations

The Company records business combinations using the acquisition method of accounting and, accordingly, allocates the fair value of purchase consideration to the assets acquired and liabilities assumed based on their fair values at the acquisition date. The excess of the fair value of purchase consideration over the fair value of the assets acquired and liabilities assumed is recorded as goodwill. The results of operations of the businesses acquired are included in the Company's consolidated results of operations beginning on the date of the acquisition.

Long-Lived Assets

Purchased intangible assets are stated at cost, net of accumulated amortization, and are amortized using the straight-line method over their estimated useful lives, ranging from two to twelve years. Fair values are determined primarily using the income approach, in which the Company projects future expected cash flows and applies an appropriate discount rate.

Long-lived assets "held and used" by the Company are reviewed for impairment whenever events or changes in circumstances indicate that their net book value may not be recoverable. When such factors and circumstances exist, the Company compares the projected undiscounted future cash flows associated with the related asset or group of assets over their estimated useful lives against their respective carrying amounts. Impairment, if any, is based on the excess of the carrying amount over the fair value of those assets and is recorded in the period in which the determination was made.

The carrying value of goodwill is reviewed at least annually by the Company for possible impairment. The goodwill impairment test is a two-step process. The first step of the impairment analysis compares the fair value of the reporting unit to the net book value of the reporting unit. In determining fair value, several valuation methodologies are allowed, although quoted market prices are the best evidence of fair value. If the results of the first step demonstrate that the net book value is greater than the fair value, the Company must proceed to step two of the analysis. Step two of the analysis compares the implied fair value of goodwill to its carrying amount. If the carrying amount of goodwill exceeds its implied fair value, an impairment loss is recognized equal to that excess. The Company tests goodwill for impairment annually as of the first day of its fourth fiscal quarter and in interim periods if events occur that would indicate that the carrying value of goodwill may be impaired.

Revenue Recognition

Revenues are generated predominately by sales of the Company's products. The Company recognizes revenue when all of the following criteria are met: 1) there is persuasive evidence that an arrangement exists, 2) delivery of goods has occurred, 3) the sales price is fixed or determinable, and 4) collectibility is reasonably assured. Generally, revenue from product sales to direct customers and contract manufacturers is recognized upon shipment.

A portion of the Company's sales are made to distributors under agreements allowing certain rights of return and price protection related to the final selling price to the end customers. Accordingly, the Company defers revenue and cost of revenue on such sales until the distributors sell the product to the end customers. The net balance of deferred revenue less deferred cost of revenue associated with inventory shipped to a distributor but not yet sold to an end customer is recorded in the deferred

Silicon Laboratories Inc.
Notes to Consolidated Financial Statements
December 31, 2016 (Continued)

2. Significant Accounting Policies (Continued)

income on shipments to distributors liability on the Consolidated Balance Sheet. Such net deferred income balance reflects the Company's estimate of the impact of rights of return and price protection.

A small portion of the Company's revenues is derived from the sale of patents. The above revenue recognition criteria for patent sales are generally met upon the execution of the patent sale agreement.

Shipping and Handling

Shipping and handling costs are classified as a component of cost of revenues in the Consolidated Statements of Income.

Stock-Based Compensation

The Company has stock-based compensation plans, which are more fully described in Note 12, *Stock-Based Compensation*. The Company accounts for those plans using a fair-value method and recognizes the expense in its Consolidated Statement of Income.

Research and Development

Research and development costs are expensed as incurred. Research and development expense consists primarily of personnel-related expenses, including stock-based compensation, as well as new product masks, external consulting and services costs, equipment tooling, equipment depreciation, amortization of intangible assets, and an allocated portion of our occupancy costs. Assets purchased to support the Company's ongoing research and development activities are capitalized when related to products which have achieved technological feasibility or have an alternative future use, and are amortized over their estimated useful lives.

Advertising

Advertising costs are expensed as incurred. Advertising expenses were \$1.6 million, \$1.8 million and \$1.7 million in fiscal 2016, 2015 and 2014, respectively.

Income Taxes

The Company accounts for income taxes using the asset and liability method whereby deferred tax asset and liability account balances are determined based on differences between the financial reporting and the tax bases of assets and liabilities and are measured using the enacted tax laws and related rates that will be in effect when the differences are expected to reverse. These differences result in deferred tax assets and liabilities, which are included in the Company's Consolidated Balance Sheet. The Company then assesses the likelihood that the deferred tax assets will be realized. A valuation allowance is established against deferred tax assets to the extent the Company believes that it is more likely than not that the deferred tax assets will not be realized, taking into consideration the level of historical taxable income and projections for future taxable income over the periods in which the temporary differences are deductible.

Uncertain tax positions must meet a more-likely-than-not threshold to be recognized in the financial statements and the tax benefits recognized are measured based on the largest benefit that has

Silicon Laboratories Inc.
Notes to Consolidated Financial Statements
December 31, 2016 (Continued)

2. Significant Accounting Policies (Continued)

a greater than 50% likelihood of being realized upon final settlement. See Note 16, *Income Taxes*, for additional information.

Recent Accounting Pronouncements

In January 2017, the Financial Accounting Standards Board (FASB) issued Accounting Standards Update (ASU) No. 2017-01, *Business Combinations (Topic 805): Clarifying the Definition of a Business*. This ASU clarifies the definition of a business with the objective of adding guidance to assist entities with evaluating whether transactions should be accounted for as acquisitions (or disposals) of assets or businesses. This ASU is effective for annual periods beginning after December 15, 2017, including interim periods within those periods. The Company is currently evaluating the effect that the adoption of this ASU will have on its financial statements.

In August 2016, the FASB issued ASU No. 2016-16, *Income Taxes (Topic 740): Intra-Entity Transfers of Assets Other Than Inventory*. This ASU requires the recognition of the income tax consequences of an intra-entity transfer of an asset other than inventory when the transfer occurs. This ASU is effective for annual reporting periods beginning after December 15, 2017, including interim reporting periods within those annual reporting periods, with early adoption permitted. The amendments in this ASU should be applied on a modified retrospective basis through a cumulative-effect adjustment directly to retained earnings as of the beginning of the period of adoption. The Company has elected to early adopt this ASU on January 1, 2017. The Company currently expects to record a cumulative-effect adjustment to decrease retained earnings by between \$0.0 and \$2.5 million with a corresponding adjustment to non-current assets and deferred taxes on the Consolidated Balance Sheet.

In August 2016, the FASB issued ASU No. 2016-15, *Statement of Cash Flows (Topic 230): Classification of Certain Cash Receipts and Cash Payments*. This ASU provides guidance on statement of cash flows presentation for eight specific cash flow issues where diversity in practice exists. This ASU is effective for fiscal years beginning after December 15, 2017, and interim periods within those fiscal years. The Company is currently evaluating the effect that the adoption of this ASU will have on its financial statements.

In June 2016, the FASB issued ASU No. 2016-13, *Financial Instruments—Credit Losses (Topic 326): Measurement of Credit Losses on Financial Instruments*. This ASU requires instruments measured at amortized cost to be presented at the net amount expected to be collected. Entities are also required to record allowances for available-for-sale debt securities rather than reduce the carrying amount. This ASU is effective for fiscal years beginning after December 15, 2019, including interim periods within those fiscal years. The Company is currently evaluating the effect that the adoption of this ASU will have on its financial statements.

In March 2016, the FASB issued ASU No. 2016-09, *Compensation—Stock Compensation (Topic 718): Improvements to Employee Share-Based Payment Accounting*. This ASU simplifies several aspects of the accounting for share-based payment transactions, including the income tax consequences, classification of awards as either equity or liabilities and classification on the statement of cash flows. This ASU is effective for annual periods beginning after December 15, 2016, and interim periods within those annual periods. The Company expects the primary impact of this ASU to be the income tax effects of awards recognized in the income statement when the awards are vested or settled.

Silicon Laboratories Inc.
Notes to Consolidated Financial Statements
December 31, 2016 (Continued)

2. Significant Accounting Policies (Continued)

In February 2016, the FASB issued ASU No. 2016-02, *Leases (Topic 842)*. The core principle of Topic 842 is that a lessee should recognize the assets and liabilities that arise from leases. For operating leases, a lessee is required to recognize a right-of-use asset and a lease liability, initially measured at the present value of the lease payments, in the statement of financial position. This ASU is effective for fiscal years beginning after December 15, 2018, including interim periods within those fiscal years. The Company is currently evaluating the effect that the adoption of this ASU will have on its financial statements.

In January 2016, the FASB issued ASU No. 2016-01, *Financial Instruments—Overall (Subtopic 825-10): Recognition and Measurement of Financial Assets and Financial Liabilities*. This ASU addresses certain aspects of recognition, measurement, presentation and disclosure of financial instruments. This ASU is effective for fiscal years beginning after December 15, 2017, including interim periods within those fiscal years. The Company is currently evaluating the effect that the adoption of this ASU will have on its financial statements.

In July 2015, the FASB issued ASU No. 2015-11, *Inventory (Topic 330): Simplifying the Measurement of Inventory*. This ASU requires inventory to be measured at the lower of cost and net realizable value. Net realizable value is the estimated selling prices in the ordinary course of business, less reasonably predictable costs of completion, disposal, and transportation. This ASU is effective for fiscal years beginning after December 15, 2016, including interim periods within those fiscal years. The Company does not expect that the adoption of this ASU will have a material impact on its financial statements.

In May 2014, the FASB issued ASU No. 2014-09, *Revenue from Contracts with Customers (Topic 606)*, which supersedes the revenue recognition requirements in Accounting Standards Codification (ASC) 605, *Revenue Recognition*. The core principle of ASU 2014-09 is that an entity should recognize revenue to depict the transfer of promised goods or services to customers in an amount that reflects the consideration to which the entity expects to be entitled in exchange for those goods or services. The guidance provides a five-step process to achieve that core principle. In August 2015, the FASB issued ASU No. 2015-14, *Revenue from Contracts with Customers (Topic 606): Deferral of the Effective Date*, which deferred the effective date of ASU 2014-09 to annual reporting periods beginning after December 15, 2017, including interim periods within that reporting period. In 2016, the FASB issued the following amendments to ASC 606: ASU No. 2016-08, *Revenue from Contracts with Customers (Topic 606): Principal versus Agent Considerations (Reporting Revenue Gross versus Net)*, which clarifies the implementation guidance on principal versus agent considerations; ASU No. 2016-10, *Revenue from Contracts with Customers (Topic 606): Identifying Performance Obligations and Licensing*, which clarifies guidance on identification of performance obligations and licensing implementation; ASU No. 2016-12, *Compensation—Revenue from Contracts with Customers (Topic 606): Narrow-Scope Improvements and Practical Expedients*, which provides clarifying guidance on assessing collectibility, presentation of sales taxes, noncash consideration, contract modifications and completed contracts; and ASU No. 2016-20, *Technical Corrections and Improvements to Topic 606, Revenue from Contracts with Customers*, which clarifies narrow aspects of ASC 606 or corrects unintended application of the guidance. The standard may be applied retrospectively to each prior period presented (full retrospective method) or retrospectively with the cumulative effect recognized as of the date of initial application (modified retrospective method). Under the new standard, the Company expects the timing of revenue recognition from sales to distributors to be accelerated. The Company will recognize revenue at the time of sale to the distributor, net of the impact of estimated price adjustments and rights of return.

Silicon Laboratories Inc.
Notes to Consolidated Financial Statements
December 31, 2016 (Continued)

2. Significant Accounting Policies (Continued)

The Company currently anticipates adopting this standard using the modified retrospective method. The Company is continuing to evaluate the effect that the adoption will have on its financial statements.

3. Earnings Per Share

The following table sets forth the computation of basic and diluted earnings per share (in thousands, except per share data):

	Year Ended		
	December 31, 2016	January 2, 2016	January 3, 2015
Net income	\$61,494	\$29,586	\$38,021
Shares used in computing basic earnings per share	41,713	42,309	42,970
Effect of dilutive securities:			
Stock options and other stock-based awards	663	636	823
Shares used in computing diluted earnings per share	<u>42,376</u>	<u>42,945</u>	<u>43,793</u>
Earnings per share:			
Basic	\$ 1.47	\$ 0.70	\$ 0.88
Diluted	\$ 1.45	\$ 0.69	\$ 0.87

For fiscal years ended December 31, 2016, January 2, 2016 and January 3, 2015, approximately 0.1 million, 0.1 million and 0.1 million shares, respectively, consisting of restricted stock awards (RSUs), market stock awards (MSUs) and stock options, were not included in the diluted earnings per share calculation since the shares were anti-dilutive.

Silicon Laboratories Inc.
Notes to Consolidated Financial Statements
December 31, 2016 (Continued)

4. Fair Value of Financial Instruments

The following summarizes the valuation of the Company's financial instruments (in thousands). The tables do not include either cash on hand or assets and liabilities that are measured at historical cost or any basis other than fair value.

<u>Description</u>	Fair Value Measurements at December 31, 2016 Using			<u>Total</u>
	<u>Quoted Prices in Active Markets for Identical Assets (Level 1)</u>	<u>Significant Other Observable Inputs (Level 2)</u>	<u>Significant Unobservable Inputs (Level 3)</u>	
Assets:				
Cash equivalents:				
Money market funds	\$69,432	\$ —	\$ —	\$ 69,432
Certificates of deposit	—	7,153	—	7,153
Municipal bonds	—	3,904	—	3,904
Total cash equivalents	<u>\$69,432</u>	<u>\$ 11,057</u>	<u>\$ —</u>	<u>\$ 80,489</u>
Short-term investments:				
Municipal bonds	\$ —	\$ 79,702	\$ —	\$ 79,702
Corporate bonds	—	31,036	—	31,036
Variable-rate demand notes	—	16,400	—	16,400
U.S. government bonds	12,416	—	—	12,416
Asset-backed securities	—	8,173	—	8,173
Commercial paper	—	5,233	—	5,233
International government bonds	—	1,001	—	1,001
Total short-term investments	<u>\$12,416</u>	<u>\$141,545</u>	<u>\$ —</u>	<u>\$153,961</u>
Long-term investments:				
Auction rate securities	<u>\$ —</u>	<u>\$ —</u>	<u>\$5,196</u>	<u>\$ 5,196</u>
Total long-term investments	<u>\$ —</u>	<u>\$ —</u>	<u>\$5,196</u>	<u>\$ 5,196</u>
Other assets, net:				
Derivative instruments	<u>\$ —</u>	<u>\$ 1,808</u>	<u>\$ —</u>	<u>\$ 1,808</u>
Total	<u>\$ —</u>	<u>\$ 1,808</u>	<u>\$ —</u>	<u>\$ 1,808</u>
Total	<u><u>\$81,848</u></u>	<u><u>\$154,410</u></u>	<u><u>\$5,196</u></u>	<u><u>\$241,454</u></u>

Silicon Laboratories Inc.
Notes to Consolidated Financial Statements
December 31, 2016 (Continued)

4. Fair Value of Financial Instruments (Continued)

Description	Fair Value Measurements at January 2, 2016 Using			Total
	Quoted Prices in Active Markets for Identical Assets (Level 1)	Significant Other Observable Inputs (Level 2)	Significant Unobservable Inputs (Level 3)	
Assets:				
Cash equivalents:				
Money market funds	\$37,721	\$ —	\$ —	\$ 37,721
Commercial paper	—	11,272	—	11,272
Certificates of deposit	—	2,845	—	2,845
U.S. government agency	—	1,599	—	1,599
Municipal bonds	—	1,577	—	1,577
Total cash equivalents	\$37,721	\$ 17,293	\$ —	\$ 55,014
Short-term investments:				
Municipal bonds	\$ —	\$ 93,516	\$ —	\$ 93,516
Commercial paper	—	11,176	—	11,176
Variable-rate demand notes	—	8,995	—	8,995
Certificates of deposit	—	8,000	—	8,000
U.S. government agency	—	3,998	—	3,998
International government bonds	—	2,220	—	2,220
Corporate bonds	—	996	—	996
Total short-term investments	\$ —	\$128,901	\$ —	\$128,901
Long-term investments:				
Auction rate securities	\$ —	\$ —	\$ 7,126	\$ 7,126
Total long-term investments	\$ —	\$ —	\$ 7,126	\$ 7,126
Other assets, net:				
Derivative instruments	\$ —	\$ 92	\$ —	\$ 92
Total	\$ —	\$ 92	\$ —	\$ 92
Total	<u>\$37,721</u>	<u>\$146,286</u>	<u>\$ 7,126</u>	<u>\$191,133</u>
Liabilities:				
Accrued expenses:				
Contingent consideration	\$ —	\$ —	\$ 4,749	\$ 4,749
Other non-current liabilities:				
Contingent consideration	\$ —	\$ —	\$ 9,324	\$ 9,324
Total	<u>\$ —</u>	<u>\$ —</u>	<u>\$14,073</u>	<u>\$ 14,073</u>

Valuation methodology

The Company's cash equivalents and short-term investments that are classified as Level 2 are valued using non-binding market consensus prices that are corroborated with observable market data; quoted market prices for similar instruments in active markets; or pricing models, such as a discounted cash flow model, with all significant inputs derived from or corroborated with observable market data.

Silicon Laboratories Inc.
Notes to Consolidated Financial Statements
December 31, 2016 (Continued)

4. Fair Value of Financial Instruments (Continued)

Investments classified as Level 3 are valued using a discounted cash flow model. The assumptions used in preparing the discounted cash flow model include estimates for interest rates, amount of cash flows, expected holding periods of the securities and a discount to reflect the Company's inability to liquidate the securities. The Company's derivative instruments are valued using discounted cash flow models. The assumptions used in preparing the valuation models include quoted interest swap rates, foreign exchange rates, forward and spot prices for currencies, and market observable data of similar instruments.

The Company's contingent consideration is valued using a Monte Carlo simulation model or a probability weighted discounted cash flow model. The assumptions used in preparing the Monte Carlo simulation model include estimates for revenue growth rates, revenue volatility, contractual terms and discount rates. The assumptions used in preparing the discounted cash flow model include estimates for outcomes if milestone goals are achieved, the probability of achieving each outcome and discount rates.

Available-for-sale investments

The Company's investments typically have original maturities greater than ninety days as of the date of purchase. Investments are reported at fair value, with unrealized gains and losses, net of tax, recorded as a component of accumulated other comprehensive income (loss) in the Consolidated Balance Sheet. The following summarizes the contractual underlying maturities of the Company's available-for-sale investments at December 31, 2016 (in thousands):

	<u>Cost</u>	<u>Fair Value</u>
Due in one year or less	\$159,670	\$159,624
Due after one year through ten years	59,628	59,426
Due after ten years	21,400	20,596
	<u>\$240,698</u>	<u>\$239,646</u>

Silicon Laboratories Inc.
Notes to Consolidated Financial Statements
December 31, 2016 (Continued)

4. Fair Value of Financial Instruments (Continued)

The available-for-sale investments that were in a continuous unrealized loss position, aggregated by length of time that individual securities have been in a continuous loss position, were as follows (in thousands):

	Less Than 12 Months		12 Months or Greater		Total	
	Fair Value	Gross Unrealized Losses	Fair Value	Gross Unrealized Losses	Fair Value	Gross Unrealized Losses
As of December 31, 2016						
Municipal bonds	\$ 69,379	\$(140)	\$ —	\$ —	\$ 69,379	\$ (140)
Corporate bonds	18,561	(128)	—	—	18,561	(128)
U.S. government bonds	10,364	(16)	—	—	10,364	(16)
Auction rate securities	—	—	5,196	(804)	5,196	(804)
Asset-backed securities	3,176	(4)	—	—	3,176	(4)
	<u>\$101,480</u>	<u>\$(288)</u>	<u>\$5,196</u>	<u>\$(804)</u>	<u>\$106,676</u>	<u>\$(1,092)</u>
	Less Than 12 Months		12 Months or Greater		Total	
	Fair Value	Gross Unrealized Losses	Fair Value	Gross Unrealized Losses	Fair Value	Gross Unrealized Losses
As of January 2, 2016						
Municipal bonds	\$29,271	\$(30)	\$1,198	\$ (2)	\$30,469	\$ (32)
Auction rate securities	—	—	7,126	(874)	7,126	(874)
International government bonds	2,220	(7)	—	—	2,220	(7)
Corporate bonds	996	(3)	—	—	996	(3)
	<u>\$32,487</u>	<u>\$(40)</u>	<u>\$8,324</u>	<u>\$(876)</u>	<u>\$40,811</u>	<u>\$(916)</u>

The gross unrealized losses as of December 31, 2016 and January 2, 2016 were due primarily to the illiquidity of the Company's auction-rate securities and, to a lesser extent, to changes in market interest rates. The Company's auction-rate securities have been illiquid since 2008 when auctions for the securities failed because sell orders exceeded buy orders. These securities have a contractual maturity date of 2046 at December 31, 2016. The Company is unable to predict if these funds will become available before their maturity date.

The Company does not expect to need access to the capital represented by any of its auction-rate securities prior to their maturities. The Company does not intend to sell, and believes it is not more likely than not that it will be required to sell, its auction-rate securities before their anticipated recovery in market value or final settlement at the underlying par value. The Company believes that the credit ratings and credit support of the security issuers indicate that they have the ability to settle the securities at par value. As such, the Company has determined that no other-than-temporary impairment losses existed as of December 31, 2016.

At December 31, 2016 and January 2, 2016, there were no material unrealized gains associated with the Company's available-for-sale investments.

Silicon Laboratories Inc.
Notes to Consolidated Financial Statements
December 31, 2016 (Continued)

4. Fair Value of Financial Instruments (Continued)

Level 3 fair value measurements

The following summarizes quantitative information about Level 3 fair value measurements.

Auction rate securities

Fair Value at December 31, 2016 (000s)	Valuation Technique	Unobservable Input	Weighted Average
\$5,196	Discounted cash flow	Estimated yield	1.09%
		Expected holding period	10 years
		Estimated discount rate	3.89%

The Company has followed an established internal control procedure used in valuing auction rate securities. The procedure involves the analysis of valuation techniques and evaluation of unobservable inputs commonly used by market participants to price similar instruments, and which have been demonstrated to provide reasonable estimates of prices obtained in actual market transactions. Outputs from the valuation process are assessed against various market sources when they are available, including marketplace quotes, recent trades of similar illiquid securities, benchmark indices and independent pricing services. The technique and unobservable input parameters may be recalibrated periodically to achieve an appropriate estimation of the fair value of the securities.

Significant changes in any of the unobservable inputs used in the fair value measurement of auction rate securities in isolation could result in a significantly lower or higher fair value measurement. An increase in expected yield would result in a higher fair value measurement, whereas an increase in expected holding period or estimated discount rate would result in a lower fair value measurement. Generally, a change in the assumptions used for expected holding period is accompanied by a directionally similar change in the assumptions used for estimated yield and discount rate.

Contingent consideration

The Company has followed an established internal control procedure used in valuing contingent consideration. The valuation of contingent consideration for the Energy Micro acquisition was based on a Monte Carlo simulation model. The fair value of this valuation was estimated on a quarterly basis through a collaborative effort by the Company's sales, marketing and finance departments.

Silicon Laboratories Inc.
Notes to Consolidated Financial Statements
December 31, 2016 (Continued)

4. Fair Value of Financial Instruments (Continued)

The following summarizes the activity in Level 3 financial instruments for the years ended December 31, 2016 and January 2, 2016 (in thousands):

Assets

	Year Ended	
	December 31, 2016	January 2, 2016
<u>Auction Rate Securities</u>		
Beginning balance	\$ 7,126	\$7,419
Settlements	(2,000)	—
Gain (loss) included in other comprehensive income (loss)	70	(293)
Ending balance	<u>\$ 5,196</u>	<u>\$7,126</u>

Liabilities

	Year Ended	
	December 31, 2016	January 2, 2016
<u>Contingent Consideration (1)</u>		
Beginning balance	\$ 14,073	\$18,438
Settlements (2)	(11,375)	(4,464)
(Gain) loss recognized in earnings (3)	(2,698)	99
Balance at December 31, 2016	<u>\$ —</u>	<u>\$14,073</u>
Net loss for the period included in earnings attributable to contingent consideration held at the end of the period:	<u>\$ —</u>	<u>\$ (99)</u>

- (1) In connection with the acquisition of Energy Micro, the Company recorded contingent consideration based upon the expected achievement of certain milestone goals. Changes to the fair value of contingent consideration due to changes in assumptions used in preparing the valuation model were recorded in selling, general and administrative expenses in the Consolidated Statement of Income.
- (2) On March 11, 2016, the Company entered into an agreement which settled the total amount of contingent consideration related to the Energy Micro acquisition (including all amounts for fiscal 2015 through 2018). See Note 8, *Acquisitions*, for additional information.
- (3) The gain recognized in earnings was due to the settlement of the Energy Micro contingent consideration. This gain was offset in part by a charge of approximately \$2.7 million recorded in fiscal 2016 for a portion of the contingent consideration accounted for as post-combination compensation expense.

Fair values of other financial instruments

The Company's debt under the Credit Facilities bears interest at the Eurodollar rate plus an applicable margin. The Credit Facilities are recorded at cost, but are measured at fair value for

Silicon Laboratories Inc.
Notes to Consolidated Financial Statements
December 31, 2016 (Continued)

4. Fair Value of Financial Instruments (Continued)

disclosure purposes. Fair value is estimated based on Level 2 inputs, using a discounted cash flow analysis of future principal payments and projected interest based on current market rates. As of December 31, 2016 and January 2, 2016, the fair value of the Company's debt under the Credit Facilities was approximately \$72.5 million and \$77.5 million, respectively.

The Company's other financial instruments, including cash, accounts receivable and accounts payable, are recorded at amounts that approximate their fair values due to their short maturities.

5. Derivative Financial Instruments

The Company uses derivative financial instruments to manage certain exposures to the variability of interest rates and foreign currency exchange rates. The Company's objective is to offset increases and decreases in expenses resulting from these exposures with gains and losses on the derivative contracts, thereby reducing volatility of earnings.

Interest Rate Swaps

The Company is exposed to interest rate fluctuations in the normal course of its business, including through its Credit Facilities. The interest payments on the facility are calculated using a variable-rate of interest. The Company has entered into an interest rate swap agreement with an original notional value of \$72.5 million (equal to the outstanding balance of the Credit Facilities at July 8, 2016) and, effectively, converted the Eurodollar portion of the variable-rate interest payments to fixed-rate interest payments through July 2020. The Company's previous swap agreement with a remaining notional value of \$72.5 million was terminated on July 8, 2016.

The Company estimates the fair values of interest rate swaps based on quoted prices and market observable data of similar instruments. If the Credit Facilities or the interest rate swap agreement is terminated prior to maturity, the fair value of the interest rate swap recorded in accumulated other comprehensive income (loss) may be recognized in the Consolidated Statement of Income based on an assessment of the agreements at the time of termination. The fair value of the interest rate swap terminated on July 8, 2016 was not material. The Company did not discontinue any other cash flow hedges in any of the periods presented.

The Company measures the effectiveness of its cash flow hedge by comparing the change in fair value of the hedged variable interest payments with the change in fair value of the interest rate swap. The Company recognizes ineffective portions of the hedge, as well as amounts not included in the assessment of effectiveness, in the Consolidated Statement of Income. As of December 31, 2016, no portion of the gains or losses from the Company's hedging instrument was excluded from the assessment of effectiveness. Hedge ineffectiveness was not material for any of the periods presented.

The Company's derivative financial instrument in cash flow hedging relationships consisted of the following (in thousands):

	<u>Balance Sheet Location</u>	<u>Fair Value</u>	
		<u>December 31, 2016</u>	<u>January 2, 2016</u>
Interest rate swap	Other assets, net	\$1,808	\$92

Silicon Laboratories Inc.
Notes to Consolidated Financial Statements
December 31, 2016 (Continued)

5. Derivative Financial Instruments (Continued)

The before-tax effect of derivative instruments in cash flow hedging relationships was as follows (in thousands):

	Gain (Loss) Recognized in OCI on Derivatives (Effective Portion) during the Year Ended			Location of Loss Reclassified into Income	Loss Reclassified from Accumulated OCI into Income (Effective Portion) during the Year Ended		
	December 31, 2016	January 2, 2016	January 3, 2015		December 31, 2016	January 2, 2016	January 3, 2015
Interest rate swaps	\$1,466	\$(728)	\$(799)	Interest expense	\$(249)	\$(489)	\$(618)

The Company expects to reclassify \$0.1 million of its interest rate swap gains included in accumulated other comprehensive income (loss) as of December 31, 2016 into earnings in the next 12 months, which would be offset by higher interest payments.

Foreign Currency Forward Contracts

The Company uses foreign currency forward contracts to manage exposure to foreign exchange risk. As of December 31, 2016 and January 2, 2016, the Company held one foreign currency forward contract denominated in Norwegian Krone with a notional value of \$3.9 million and \$5.1 million, respectively. The fair value of the contracts was not material as of December 31, 2016 and January 2, 2016. The contract held as of December 31, 2016 has a maturity date of March 29, 2017 and it was not designated as a hedging instrument.

The before-tax effect of derivative instruments not designated as hedging instruments was as follows (in thousands):

Gain (Loss) Recognized in Income	Year Ended			Location
	December 31, 2016	January 2, 2016	January 3, 2015	
Foreign currency forward contracts	\$(92)	\$935	\$1,075	Other, net

6. Balance Sheet Details

The following tables show the details of selected Consolidated Balance Sheet items (in thousands):

Accounts Receivable, Net

	December 31, 2016	January 2, 2016
Accounts receivable	\$75,035	\$74,272
Allowance for doubtful accounts	(634)	(671)
	<u>\$74,401</u>	<u>\$73,601</u>

Silicon Laboratories Inc.
Notes to Consolidated Financial Statements
December 31, 2016 (Continued)

6. Balance Sheet Details (Continued)

Inventories

	<u>December 31, 2016</u>	<u>January 2, 2016</u>
Work in progress	\$40,755	\$36,774
Finished goods	18,823	17,121
	<u>\$59,578</u>	<u>\$53,895</u>

Prepaid Expenses and Other Current Assets

	<u>December 31, 2016</u>	<u>January 2, 2016</u>
Distributor advances	\$40,205	\$36,743
Other	21,600	15,915
	<u>\$61,805</u>	<u>\$52,658</u>

Property and Equipment

	<u>December 31, 2016</u>	<u>January 2, 2016</u>
Buildings and improvements	\$ 94,977	\$ 94,607
Equipment	57,677	55,072
Computers and purchased software	35,492	29,663
Leasehold interest in ground leases	23,840	23,840
Furniture and fixtures	5,484	4,777
Leasehold improvements	10,083	9,204
	227,553	217,163
Accumulated depreciation	(97,994)	(86,031)
	<u>\$129,559</u>	<u>\$131,132</u>

Accrued Expenses

	<u>December 31, 2016</u>	<u>January 2, 2016</u>
Accrued compensation and benefits	\$28,781	\$27,304
Other	21,319	24,827
	<u>\$50,100</u>	<u>\$52,131</u>

Silicon Laboratories Inc.
Notes to Consolidated Financial Statements
December 31, 2016 (Continued)

6. Balance Sheet Details (Continued)

Other Non-current Liabilities

	<u>December 31, 2016</u>	<u>January 2, 2016</u>
Software license accruals	\$14,436	\$ 1,107
Deferred tax liabilities	13,119	13,741
Other	<u>15,136</u>	<u>25,680</u>
	<u>\$42,691</u>	<u>\$40,528</u>

7. Risks and Uncertainties

Financial Instruments

Financial instruments that potentially subject the Company to significant concentrations of credit risk consist primarily of cash equivalents, investments, accounts receivable, notes receivable and derivatives. The Company places its cash equivalents and investments primarily in municipal bonds, money market funds, corporate bonds, variable-rate demand notes, U.S. government bonds, asset-back securities, certificates of deposit, commercial paper, auction-rate securities and international government bonds. Concentrations of credit risk with respect to accounts receivable are primarily due to customers with large outstanding balances. The Company's customers that accounted for greater than 10% of accounts receivable consisted of the following:

	<u>December 31, 2016</u>	<u>January 2, 2016</u>
Edom Technology	19%	17%
Arrow Electronics	13%	17%
Avnet	12%	14%

The Company performs periodic credit evaluations of its customers' financial condition and generally requires no collateral from its customers. The Company provides an allowance for potential credit losses based upon the expected collectibility of such receivables. Losses have not been significant for any of the periods presented.

The Company holds two notes receivable for \$1.5 million and \$0.7 million from a privately held company. The notes have a maturity date of the earlier of December 31, 2018 or certain liquidity events and were recorded in other assets, net in the Consolidated Balance Sheet.

The Company holds an equity investment in another privately held company with a carrying value of \$2.8 million as of December 31, 2016. The investment is accounted for under the cost method and was recorded in other assets, net in the Consolidated Balance Sheet.

As a result of its use of derivative instruments, the Company is exposed to the risk that its counterparties will fail to meet their contractual obligations. To mitigate this counterparty credit risk, the Company has a policy to enter into contracts with only selected major financial institutions. The Company periodically reviews and re-assesses the creditworthiness of such counterparties based on a variety of factors.

Silicon Laboratories Inc.
Notes to Consolidated Financial Statements
December 31, 2016 (Continued)

7. Risks and Uncertainties (Continued)

Distributor Advances

On sales to distributors, the Company's payment terms often require the distributor to initially pay amounts owed to the Company for an amount in excess of their ultimate cost. The Company's sales price to its distributors may be higher than the amount that the distributors will ultimately owe the Company because distributors often negotiate price reductions after purchasing the product from the Company and such reductions are often significant. These negotiated price discounts are not granted until the distributor sells the product to the end customer, which may occur after the distributor has paid the original invoice amount to the Company. Payment of invoices prior to receiving an associated discount can have an adverse impact on the working capital of the Company's distributors. Accordingly, the Company has entered into agreements with certain distributors whereby it advances cash to the distributors to reduce the distributor's working capital requirements. The advance amounts are based on the distributor's inventory balance, and are adjusted quarterly. Such amounts are recorded in prepaid expenses and other current assets in the Consolidated Balance Sheet. The terms of these advances are set forth in binding legal agreements and are unsecured, bear no interest on unsettled balances and are due upon demand. The agreements governing these advances can be cancelled by the Company at any time.

Suppliers

A significant portion of the Company's products are fabricated by Taiwan Semiconductor Manufacturing Co. (TSMC) or TSMC's affiliates and Semiconductor Manufacturing International Corporation (SMIC). The inability of TSMC or SMIC to deliver wafers to the Company on a timely basis could impact the production of the Company's products for a substantial period of time, which could have a material adverse effect on the Company's business, financial condition and results of operations.

Customers

The Company sells directly to end customers, distributors and contract manufacturers. Although the Company actually sells the products to, and is paid by, distributors and contract manufacturers, the Company refers to the end customer as its customer. None of the Company's contract manufacturers accounted for greater than 10% of revenue during fiscal 2016, 2015 or 2014. The Company's end customers and distributors that accounted for greater than 10% of revenue consisted of the following:

	Year Ended		
	December 31, 2016	January 2, 2016	January 3, 2015
<i>End Customers</i>			
Samsung*	**	**	12%
<i>Distributors</i>			
Edom Technology	17%	20%	20%
Avnet	13%	12%	12%
Arrow Electronics	11%	**	**

* Samsung's purchases were across a variety of product areas.

** Less than 10% of revenue

Silicon Laboratories Inc.
Notes to Consolidated Financial Statements
December 31, 2016 (Continued)

8. Acquisitions

Micrium

On October 3, 2016, the Company acquired Micrium, a private company. Micrium is a supplier of real-time operating system (RTOS) software for the IoT. The Company acquired Micrium for approximately \$12.4 million, consisting of approximately \$8.2 million in cash and \$4.2 million in stock consideration. An additional approximately \$1.0 million in stock consideration was accounted for as a transaction separate from the business combination based on its economic substance and will be recorded as post-combination compensation expense over four years. Approximately \$1.5 million of the consideration was held in escrow as security for breaches of warranties and certain other expressly enumerated matters.

The purchase price was allocated as follows: intangible assets—\$9.5 million; goodwill—\$3.4 million; and other net assets—\$(0.5) million. A portion of the goodwill is deductible for tax purposes. The allocation of the purchase price is preliminary and subject to change, primarily for the valuation of certain assets and accruals and the finalization of income tax matters. Accordingly, adjustments may be made to the values of the assets acquired and liabilities assumed as additional information is obtained about the facts and circumstances that existed at the valuation date.

Pro forma information related to this acquisition has not been presented because it would not be materially different from amounts reported. The Company recorded approximately \$0.3 million of acquisition-related costs in selling, general and administrative expenses during fiscal 2016.

Telegesis

On November 20, 2015, the Company acquired Telegesis (UK) Limited, a limited liability company incorporated in England and Wales. Telegesis is a supplier of wireless mesh networking modules based on the Company's zigbee and Thread technology, targeting applications in the smart energy, home automation and industrial automation markets. The Company acquired Telegesis for cash consideration of \$19.9 million. Approximately \$2.9 million of the consideration was held in escrow as security for breaches of warranties and certain other expressly enumerated matters.

The Company believes that this strategic acquisition accelerates its roadmap for zigbee and Thread modules. This factor contributed to a purchase price that was in excess of the fair value of the net

Silicon Laboratories Inc.
Notes to Consolidated Financial Statements
December 31, 2016 (Continued)

8. Acquisitions (Continued)

assets acquired and, as a result, the Company recorded goodwill. The goodwill is not deductible for tax purposes. The purchase price was allocated as follows (in thousands):

	<u>Amount</u>	<u>Weighted-Average Amortization Period (Years)</u>
Intangible assets:		
In-process research and development	\$ 10	Not amortized
Developed technology	4,980	7
Customer relationships	2,000	3
Trademarks	400	3
	<u>7,390</u>	
Cash and cash equivalents	717	
Other current assets	4,545	
Goodwill	9,344	
Other non-current assets	131	
Current liabilities	(689)	
Non-current deferred tax liabilities	<u>(1,508)</u>	
Total purchase price	<u>\$19,930</u>	

Pro forma information related to this acquisition has not been presented because it would not be materially different from amounts reported. The Company recorded approximately \$0.5 million of acquisition-related costs in selling, general and administrative expenses during fiscal 2015.

Bluegiga

On January 30, 2015, the Company acquired Bluegiga Technologies Oy, a private company based in Finland. Bluegiga is a provider of Bluetooth Smart, Bluetooth Classic and Wi-Fi modules and software stacks for a multitude of applications in the IoT, industrial automation, consumer electronics, automotive, retail, residential, and health and fitness markets. The Company acquired Bluegiga for cash consideration of approximately \$58.0 million.

The Company believes that this strategic acquisition will accelerate its entry into the wireless module market. This factor contributed to a purchase price that was in excess of the fair value of the

Silicon Laboratories Inc.
Notes to Consolidated Financial Statements
December 31, 2016 (Continued)

8. Acquisitions (Continued)

net assets acquired and, as a result, the Company recorded goodwill. The goodwill is not deductible for tax purposes. The purchase price was allocated as follows (in thousands):

	<u>Amount</u>	<u>Weighted-Average Amortization Period (Years)</u>
Intangible assets:		
In-process research and development	\$ 5,710	Not amortized
Developed technology	12,190	8
Customer relationships	6,670	4
Trademarks	880	3
	<u>25,450</u>	
Cash and cash equivalents	1,132	
Other current assets	6,156	
Goodwill	34,597	
Other non-current assets	208	
Current liabilities	(3,289)	
Non-current deferred tax liabilities	(3,780)	
Long-term debt	(2,232)	
Other non-current liabilities	(220)	
Total purchase price	<u>\$58,022</u>	

In-process research and development (IPR&D) represents acquired technology that had not achieved technological feasibility as of the acquisition date and had no alternative future use. The IPR&D recorded in connection with the acquisition of Bluegiga consisted primarily of Bluetooth Smart Ready and Bluetooth Smart modules and software stacks. The fair value of these technologies was determined using the income approach. The discount rate applicable to the cash flows was 16.1%.

Pro forma information related to this acquisition has not been presented because it would not be materially different from amounts reported. The Company recorded approximately \$1.2 million of acquisition-related costs in selling, general and administrative expenses during fiscal 2015.

Energy Micro

On July 1, 2013, the Company acquired Energy Micro. In the first quarter of 2015, the Company made the following payments in connection with the Energy Micro acquisition: (a) approximately \$20.0 million was paid for the release of the holdback; and (b) approximately \$6.3 million was paid for the first annual period of the earn-out. Approximately \$1.8 million of the earn-out payment was recorded as compensation expense during fiscal 2014. The remaining approximately \$4.5 million of the earn-out payment represented additional consideration.

On March 11, 2016, the Company entered into an agreement with Energy AS, the former parent of Energy Micro. The agreement settled the amount of the earn-out to be paid for fiscal 2015 through 2018. The total settlement amount was approximately \$16.0 million (in lieu of potential payments of up to \$26.7 million) and was paid on May 11, 2016. The settlement amount represented approximately \$11.4 million of additional consideration and approximately \$4.6 million of compensation expense (of

Silicon Laboratories Inc.
Notes to Consolidated Financial Statements
December 31, 2016 (Continued)

8. Acquisitions (Continued)

which approximately \$2.7 million was recorded in fiscal 2016 and approximately \$1.9 million was recorded in fiscal 2015). The compensation expense recorded in fiscal 2016 was offset in part by a gain of approximately \$2.7 million to adjust the consideration portion of the earn-out to fair value due to the settlement.

9. Goodwill and Other Intangible Assets

Goodwill

The following summarizes the activity in goodwill for the years ended December 31, 2016 and January 2, 2016 (in thousands):

	Year Ended	
	December 31, 2016	January 2, 2016
Beginning balance	\$272,722	\$228,781
Additions due to business combinations	3,408	43,941
Ending balance	\$276,130	\$272,722

Other Intangible Assets

The gross carrying amount and accumulated amortization of other intangible assets are as follows (in thousands):

	Weighted-Average Amortization Period (Years)	December 31, 2016		January 2, 2016	
		Gross Amount	Accumulated Amortization	Gross Amount	Accumulated Amortization
Intangible assets:					
Subject to amortization:					
Core and developed technology	9	\$157,321	\$(70,181)	\$170,541	\$(70,135)
Customer relationships	7	24,970	(11,356)	23,170	(7,259)
Patents	6	3,000	(2,250)	3,022	(1,763)
Trademarks	7	3,690	(1,629)	3,490	(952)
	9	188,981	(85,416)	200,223	(80,109)
Not subject to amortization:					
In-process research and development	Not amortized	—	—	1,240	—
Total intangible assets		\$188,981	\$(85,416)	\$201,463	\$(80,109)

Gross intangible assets decreased \$12.5 million in fiscal 2016 due to the removal of \$22.0 million of fully amortized assets. This decrease was offset by \$9.5 million in assets added due to the acquisition of Micrium.

Silicon Laboratories Inc.
Notes to Consolidated Financial Statements
December 31, 2016 (Continued)

9. Goodwill and Other Intangible Assets (Continued)

Amortization expense related to intangible assets for fiscal 2016, 2015 and 2014 was \$27.3 million, \$26.5 million and \$17.9 million, respectively. The estimated aggregate amortization expense for intangible assets subject to amortization for each of the five succeeding fiscal years is as follows (in thousands):

<u>Fiscal Year</u>	
2017	\$24,957
2018	22,890
2019	17,192
2020	14,697
2021	10,308

10. Debt

On July 31, 2012, the Company and certain of its domestic subsidiaries (the “Guarantors”) entered into a \$230 million five-year Credit Agreement (the “Credit Agreement”), which consisted of a \$100 million Term Loan Facility and a \$130 million Revolving Credit Facility (collectively, the “Credit Facilities”). On July 24, 2015, the Company and the Guarantors amended the Credit Agreement (the “Amended Credit Agreement”) in order to, among other things, increase the borrowing capacity under the Revolving Credit Facility to \$300 million, eliminate the Term Loan Facility and extend the maturity date to five years from the closing date. On July 24, 2015, the Company borrowed \$82.5 million under the Amended Credit Agreement and paid off the remaining balance of its Term Loan Facility.

The Amended Credit Agreement includes a \$25 million letter of credit sublimit and a \$10 million swingline loan sublimit. The Company also has an option to increase the size of the borrowing capacity by up to an aggregate of \$200 million in additional commitments, subject to certain conditions.

The Revolving Credit Facility, other than swingline loans, will bear interest at the Eurodollar rate plus an applicable margin or, at the option of the Company, a base rate (defined as the highest of the Wells Fargo prime rate, the Federal Funds rate plus 0.50% and the Eurodollar Base Rate plus 1.00%) plus an applicable margin. Swingline loans accrue interest at the base rate plus the applicable margin for base rate loans. The applicable margins for the Eurodollar rate loans range from 1.25% to 2.00% and for base rate loans range from 0.25% to 1.00%, depending in each case, on the leverage ratio as defined in the Agreement.

The Amended Credit Agreement contains various conditions, covenants and representations with which the Company must be in compliance in order to borrow funds and to avoid an event of default, including financial covenants that the Company must maintain a leverage ratio (funded debt/EBITDA) of no more than 3.00 to 1 and a minimum fixed charge coverage ratio (EBITDA/interest payments, income taxes and capital expenditures) of no less than 1.25 to 1. As of December 31, 2016, the Company was in compliance with all covenants of the Amended Credit Agreement. The Company’s obligations under the Amended Credit Agreement are guaranteed by the Guarantors and are secured by a security interest in substantially all assets of the Company and the Guarantors.

Silicon Laboratories Inc.
Notes to Consolidated Financial Statements
December 31, 2016 (Continued)

10. Debt (Continued)

Interest Rate Swap Agreement

In connection with the outstanding balance of the Credit Facilities at July 8, 2016, the Company entered into an interest rate swap agreement as a hedge against the Eurodollar portion of such variable interest payments. Under the terms of the swap agreement, the Company effectively converted the Eurodollar portion of the interest on the Credit Facilities to a fixed interest rate of 0.875% through July 2020. As of December 31, 2016, the combined interest rate of the Credit Facilities (which includes an applicable margin) and the interest rate swap was 2.375%. See Note 5, *Derivative Financial Instruments*, for additional information.

11. Stockholders' Equity

Common Stock

The Company issued 1.1 million shares of common stock during fiscal 2016, including approximately 0.1 million shares in connection with the acquisition of Micrium.

Share Repurchase Programs

The Board of Directors authorized the following share repurchase programs (in thousands):

<u>Program Authorization Date</u>	<u>Program Termination Date</u>	<u>Program Amount</u>
January 2017	December 2017	\$100,000
August 2015	December 2016	\$100,000
October 2014	December 2015	\$100,000
January 2014	January 2015	\$100,000

These programs allow for repurchases to be made in the open market or in private transactions, including structured or accelerated transactions, subject to applicable legal requirements and market conditions. The Company repurchased 0.9 million shares, 1.7 million shares and 1.7 million shares of its common stock for \$40.5 million, \$71.4 million and \$71.7 million and during fiscal 2016, 2015 and 2014, respectively. These shares were retired upon repurchase.

Silicon Laboratories Inc.
Notes to Consolidated Financial Statements
December 31, 2016 (Continued)

11. Stockholders' Equity (Continued)

Accumulated Other Comprehensive Income (Loss)

The components of accumulated other comprehensive income (loss), net of taxes, were as follows (in thousands):

	<u>Unrealized Gain on Cash Flow Hedge</u>	<u>Net Unrealized Losses on Available- For-Sale Securities</u>	<u>Total</u>
Balance at December 28, 2013	\$ 333	\$(1,017)	\$(684)
Other comprehensive income (loss) before reclassifications . .	(520)	720	200
Amount reclassified from accumulated other comprehensive income (loss)	<u>402</u>	<u>—</u>	<u>402</u>
Net change for the period	<u>(118)</u>	<u>720</u>	<u>602</u>
Balance at January 3, 2015	215	(297)	(82)
Other comprehensive income (loss) before reclassifications . .	(473)	(276)	(749)
Amount reclassified from accumulated other comprehensive income (loss)	<u>318</u>	<u>6</u>	<u>324</u>
Net change for the period	<u>(155)</u>	<u>(270)</u>	<u>(425)</u>
Balance at January 2, 2016	60	(567)	(507)
Other comprehensive income (loss) before reclassifications . .	953	(116)	837
Amount reclassified from accumulated other comprehensive income (loss)	<u>162</u>	<u>—</u>	<u>162</u>
Net change for the period	<u>1,115</u>	<u>(116)</u>	<u>999</u>
Balance at December 31, 2016	<u>\$1,175</u>	<u>\$ (683)</u>	<u>\$ 492</u>

Reclassifications From Accumulated Other Comprehensive Income (Loss)

The following table summarizes the effect on net income from reclassifications out of accumulated other comprehensive income (loss) (in thousands):

<u>Reclassification</u>	<u>Year ended</u>		
	<u>December 31, 2016</u>	<u>January 2, 2016</u>	<u>January 3, 2015</u>
Losses on cash flow hedges to:			
Interest expense	\$(249)	\$(489)	\$(618)
Gains (losses) on available-for-sales securities to:			
Interest income	<u>—</u>	<u>(10)</u>	<u>—</u>
	(249)	(499)	(618)
Income tax benefit	<u>87</u>	<u>175</u>	<u>216</u>
Total reclassifications	<u>\$(162)</u>	<u>\$(324)</u>	<u>\$(402)</u>

Silicon Laboratories Inc.
Notes to Consolidated Financial Statements
December 31, 2016 (Continued)

11. Stockholders' Equity (Continued)

Income Tax Allocated to the Components of Other Comprehensive Income (Loss)

The income tax effects of the components of other comprehensive income (loss) were as follows (in thousands):

<u>Income tax (expense) benefit on:</u>	Year ended		
	December 31, 2016	January 2, 2016	January 3, 2015
Net changes to available-for-sale securities:			
Unrealized gains (losses) arising during the period	\$ 63	\$ 149	\$(387)
Reclassification for losses included in net income	—	(4)	—
Net changes to cash flow hedges:			
Unrealized gains (losses) arising during the period	(513)	255	279
Reclassification for losses included in net income	<u>(87)</u>	<u>(171)</u>	<u>(216)</u>
	<u><u>\$(537)</u></u>	<u><u>\$ 229</u></u>	<u><u>\$(324)</u></u>

12. Stock-Based Compensation

In fiscal 2009, the stockholders of the Company approved the 2009 Stock Incentive Plan (the “2009 Plan”) and the 2009 Employee Stock Purchase Plan (the “2009 Purchase Plan”). In fiscal 2014, the stockholders of the Company approved amendments to both the 2009 Plan and the 2009 Purchase Plan. The amendments authorized additional shares of common stock for issuance, to comply with changes in applicable law, improve the Company’s corporate governance and to implement other best practices. The amended plans are currently effective.

2009 Stock Incentive Plan

Under the 2009 Plan, the following may be granted: stock options, stock appreciation rights, performance shares, performance stock units, restricted stock units (RSUs), restricted stock awards (RSAs), performance-based awards and other awards (collectively, all such grants are referred to as “awards”). The amendment of the shares of common stock reserved for issuance in the 2009 Plan created two share pools—Prior Pool and New Pool. Awards of stock options and stock appreciation rights each deduct one share from the 2009 Plan shares available for issuance for each share granted, and full value awards (awards other than for which the participant is required to pay at least the fair market value of the underlying shares on the date of grant) deduct 1.55 shares from the 2009 Plan shares available for issuance for each share granted under the Prior Pool. Awards of stock options, stock appreciation rights, and full value awards each deduct one share from the 2009 Plan shares available for issuance for each share granted under the New Pool. Awards granted under the 2009 Plan generally contain vesting provisions ranging from three to four years. The exercise price of stock options offered under the 2009 Plan may not be less than 100% of the fair market value of a share of our common stock on the date of grant. To the extent awards granted under the 2009 Plan terminate, expire or lapse for any reason, or are settled in cash, shares subject to such awards will again be available for grant.

Silicon Laboratories Inc.
Notes to Consolidated Financial Statements
December 31, 2016 (Continued)

12. Stock-Based Compensation (Continued)

2000 Stock Incentive Plan

In fiscal 2000, the Company's Board of Directors and stockholders approved the 2000 Plan. The 2000 Plan contains programs for (i) the discretionary granting of stock options to employees, non-employee board members and consultants for the purchase of shares of the Company's common stock, (ii) the discretionary issuance of common stock directly (as granted under direct issuance shares in RSAs and RSUs), (iii) the granting of special below-market stock options to executive officers and other highly compensated employees of the Company for which the exercise price can be paid using payroll deductions and (iv) the automatic issuance of stock options to non-employee board members. The discretionary issuance of common stock, RSUs and stock options generally contain vesting provisions ranging from three to eight years. If permitted by the Company, stock options can be exercised immediately and, similar to the direct issuance shares, are subject to repurchase rights which generally lapse in accordance with the vesting schedule. The repurchase rights provide that upon certain defined events, the Company can repurchase unvested shares at the price paid per share. The term of each stock option is no more than ten years from the date of grant.

Stock Grants and Modifications

The Company granted to its employees 1.3 million, 0.9 million and 0.8 million shares of full value awards and 0.2 million, 0.0 million, and 0.0 million stock options from the 2009 Plan during fiscal 2016, 2015 and 2014, respectively.

The Company recorded \$0.9 million and \$2.3 million in selling, general and administrative expense during fiscal 2016 and 2015, respectively, in connection with the modifications of certain equity awards. The modifications were pursuant to three employee terminations in fiscal 2016 and two employee terminations in fiscal 2015. There were no other significant modifications made to any stock grants during fiscal 2016, 2015 or 2014.

Included in the full value awards granted under the 2009 Plan in fiscal 2016, 2015 and 2014 were a total of 65 thousand, 89 thousand and 76 thousand market-based stock awards, respectively. The awards, also known as MSUs, provide the rights to acquire a number of shares of common stock for no cash consideration based upon achievement of specified levels of market conditions. The requisite service period for these MSUs is also the vesting period, which is generally three years. The performance criteria of the MSUs measure the difference between the total stockholders' return of the Company against that of the Philadelphia Semiconductor Sector Total Return Index.

Also included in the full value awards granted under the 2009 Plan during fiscal 2016 were 65 thousand performance-based stock awards. The awards, also known as PSUs, provide for the rights to acquire a number of shares of common stock for no cash consideration based upon the achievement of specified revenue objectives during the year. The requisite service period for these PSUs is approximately three years from the date of grant.

2009 Employee Stock Purchase Plan

The rights to purchase common stock granted under the 2009 Purchase Plan are intended to be treated as either (i) purchase rights granted under an "employee stock purchase plan," as that term is defined in Section 423(b) of the Internal Revenue Code (the "423(b) Plan"), or (ii) purchase rights

Silicon Laboratories Inc.
Notes to Consolidated Financial Statements
December 31, 2016 (Continued)

12. Stock-Based Compensation (Continued)

granted under an employee stock purchase plan that is not subject to the terms and conditions of Section 423(b) of the Internal Revenue Code (the “Non-423(b) Plan”). The Company will retain the discretion to grant purchase rights under either the 423(b) Plan or the Non-423(b) Plan. Eligible employees may purchase a limited number of shares of the Company’s common stock at no less than 85% of the fair market value of a share of common stock at prescribed purchase intervals during an offering period. Each offering period will be comprised of a series of one or more successive and/or overlapping purchase intervals and has a maximum term of 24 months. During fiscal 2016, 2015 and 2014, the Company issued 224 thousand, 210 thousand and 204 thousand shares, respectively, under the 2009 Purchase Plan to its employees. The weighted-average fair value for purchase rights granted in fiscal 2016 under the 2009 Purchase Plan was \$13.43 per share.

Accounting for Stock-Based Compensation

Stock-based compensation costs are based on the fair values on the date of grant for stock awards and stock options and on the date of enrollment for the employee stock purchase plans. The fair values of stock awards (such as RSUs, PSUs and RSAs) are estimated based on their intrinsic values. The fair values of MSUs are estimated using a Monte Carlo simulation. The fair values of stock options and employee stock purchase plans are estimated using the Black-Scholes option-pricing model.

The Black-Scholes valuation calculation requires the Company to estimate key assumptions such as future stock price volatility, expected terms, risk-free rates and dividend yield. Expected stock price volatility is based upon a combination of both historical volatility and implied volatility derived from traded options on the Company’s stock in the marketplace. Expected term is derived from an analysis of historical exercises and remaining contractual life of options. The risk-free rate is based on the U.S. Treasury yield curve in effect at the time of grant. The Company has never paid cash dividends and does not currently intend to pay cash dividends, thus it has assumed a 0% dividend yield.

The Monte Carlo simulation used to calculate the fair value of the MSUs simulates the present value of the potential outcomes of future stock prices of the Company and the Philadelphia Semiconductor Sector Total Return Index over the requisite service period. The projection of stock prices are based on the risk-free rate of return, the volatilities of the stock price of the Company and the Index, and the correlation of the stock price of the Company with the Index.

The Company must estimate potential forfeitures of stock grants and adjust compensation cost recorded accordingly. The estimate of forfeitures will be adjusted over the requisite service period to the extent that actual forfeitures differ, or are expected to differ, from such estimates. Changes in estimated forfeitures are recognized through a cumulative catch-up adjustment in the period of change and will also impact the amount of stock-based compensation expense to be recognized in future periods.

The fair values of stock options and RSUs are amortized as compensation expense on a straight-line basis over the vesting period of the grants. The fair values of RSAs are fully expensed in the period of grant, when shares are immediately issued with no vesting restrictions. The fair values of MSUs are amortized as compensation expense on a straight-line basis over the performance and service periods of the grants. The fair values of PSUs are amortized as compensation expense on a straight-line basis over the performance period when the performance is probable of achievement, and over the remaining service periods thereafter. Compensation expense recognized is shown in the operating activities section of the Consolidated Statements of Cash Flows.

Silicon Laboratories Inc.
Notes to Consolidated Financial Statements
December 31, 2016 (Continued)

12. Stock-Based Compensation (Continued)

The fair values estimated from the Black-Scholes option-pricing model for ESPP and stock options granted were calculated using the following assumptions:

	Year Ended		
	December 31, 2016	January 2, 2016	January 3, 2015
Employee Stock Purchase Plan			
Expected volatility	30%	31%	28%
Risk-free interest rate %	0.6%	0.2%	0.2%
Expected term (in months)	15	8	15
Dividend yield	—	—	—
	Year Ended		
	December 31, 2016	January 2, 2016	January 3, 2015
Stock Options			
Expected volatility	32%	—	—
Risk-free interest rate %	1.3%	—	—
Expected term (in years)	5.4	—	—
Dividend yield	—	—	—

The fair values estimated from Monte Carlo simulation for MSUs were calculated using the following assumptions:

	Year Ended		
	December 31, 2016	January 2, 2016	January 3, 2015
MSUs			
Expected volatility	30%	31%	33%
Risk-free interest rate %	0.9%	1.0%	0.7%
Expected term (in years)	2.9	2.9	2.8
Dividend yield	—	—	—

A summary of stock-based compensation activity with respect to fiscal 2016 follows:

	Shares (000s)	Weighted- Average Exercise Price	Weighted-Average	Aggregate Intrinsic Value (000s)
			Remaining Contractual Term (In Years)	
Stock Options				
Outstanding at January 2, 2016	212	\$34.64		
Granted	173	\$40.39		
Exercised	(137)	\$33.08		
Cancelled or expired	(20)	\$57.26		
Outstanding at December 31, 2016	228	\$37.95	7.14	\$6,165
Vested at December 31, 2016 and expected to vest	209	\$37.74	6.97	\$5,708
Exercisable at December 31, 2016	55	\$30.31	0.96	\$1,908

Silicon Laboratories Inc.
Notes to Consolidated Financial Statements
December 31, 2016 (Continued)

12. Stock-Based Compensation (Continued)

<u>RSAs and RSUs</u>	<u>Shares (000s)</u>	<u>Weighted- Average Purchase Price</u>	<u>Weighted-Average Remaining Vesting Term (In Years)</u>	<u>Aggregate Intrinsic Value (000s)</u>
Outstanding at January 2, 2016	1,554	\$—		
Granted	1,169	\$—		
Vested or issued	(871)	\$—		
Cancelled or forfeited	(163)	\$—		
Outstanding at December 31, 2016	1,689	\$—	1.05	\$109,807
Outstanding at December 31, 2016 and expected to vest	1,568	\$—	1.05	\$101,940

<u>PSUs and MSUs</u>	<u>Shares (000s)</u>	<u>Weighted- Average Purchase Price</u>	<u>Weighted-Average Remaining Vesting Term (In Years)</u>	<u>Aggregate Intrinsic Value (000s)</u>
Outstanding at January 2, 2016	250	\$—		
Granted	131	\$—		
Cancelled or forfeited	(152)	\$—		
Outstanding at December 31, 2016	229	\$—	1.41	\$14,855
Outstanding at December 31, 2016 and expected to vest	184	\$—	1.41	\$11,928

The following summarizes the Company's weighted average fair value at the date of grant:

	<u>Year Ended</u>		
	<u>December 31, 2016</u>	<u>January 2, 2016</u>	<u>January 3, 2015</u>
Per grant of RSAs and RSUs	\$40.55	\$49.14	\$47.93
Per grant of PSUs and MSUs	\$32.23	\$48.36	\$60.08

The following summarizes the Company's stock-based payment and stock option values (in thousands):

	<u>Year Ended</u>		
	<u>December 31, 2016</u>	<u>January 2, 2016</u>	<u>January 3, 2015</u>
Intrinsic value of stock options exercised	\$ 2,560	\$ 6,612	\$ 5,674
Intrinsic value of RSAs and RSUs that vested	\$36,502	\$45,298	\$32,138
Grant date fair value of RSAs and RSUs that vested	\$39,853	\$41,072	\$29,668

The Company received cash of \$2.2 million for the issuance of common stock, net of shares withheld for taxes, during fiscal 2016. The Company issues shares from the shares reserved under its stock plans upon the exercise of stock options, issuance of RSAs, vesting of RSUs and MSUs, and purchases through employee stock purchase plans. The Company does not currently expect to repurchase shares from any source to satisfy such obligation.

Silicon Laboratories Inc.
Notes to Consolidated Financial Statements
December 31, 2016 (Continued)

12. Stock-Based Compensation (Continued)

The following table presents details of stock-based compensation costs recognized in the Consolidated Statements of Income (in thousands):

	Year Ended		
	December 31, 2016	January 2, 2016	January 3, 2015
Cost of revenues	\$ 1,070	\$ 960	\$ 775
Research and development	19,573	19,451	18,521
Selling, general and administrative	18,985	22,380	19,771
	39,628	42,791	39,067
Income tax benefit	8,496	9,264	4,024
	\$31,132	\$33,527	\$35,043

The Company had approximately \$52.1 million of total unrecognized compensation costs related to granted stock options and awards as of December 31, 2016 that are expected to be recognized over a weighted-average period of approximately 2.2 years. There were no significant stock-based compensation costs capitalized into assets in any of the periods presented.

As of December 31, 2016, the Company had reserved shares of common stock for future issuance as follows (in thousands):

2000 Stock Incentive Plan	55
2009 Stock Incentive Plan	1,935
2009 Employee Stock Purchase Plan	447
Total shares reserved	2,437

13. Employee Benefit Plan

The Company maintains a defined contribution or 401(k) Plan for its qualified U.S. employees. Participants may contribute a percentage of their compensation on a pre-tax basis, subject to a maximum annual contribution imposed by the Internal Revenue Code. The Company may make discretionary matching contributions as well as discretionary profit-sharing contributions to the 401(k) Plan. The Company contributed \$3.4 million, \$3.3 million and \$3.2 million to the 401(k) Plan during fiscal 2016, 2015 and 2014, respectively.

14. Commitments and Contingencies

Operating Leases

The Company leases certain facilities under operating lease agreements that expire at various dates through 2025. Some of these arrangements contain renewal options and require the Company to pay taxes, insurance and maintenance costs.

Silicon Laboratories Inc.
Notes to Consolidated Financial Statements
December 31, 2016 (Continued)

14. Commitments and Contingencies (Continued)

Rent expense under operating leases was \$4.7 million, \$4.6 million and \$4.2 million and for fiscal 2016, 2015 and 2014, respectively. The minimum annual future rentals under the terms of these leases as of December 31, 2016 are as follows (in thousands):

<u>Fiscal Year</u>	
2017	\$ 5,139
2018	3,852
2019	2,700
2020	2,432
2021	2,286
Thereafter	<u>4,638</u>
Total minimum lease payments	<u>\$21,047</u>

Litigation

Patent Litigation

On January 21, 2014, Cresta Technology Corporation (“Cresta Technology”), a Delaware corporation, filed a lawsuit against the Company, Samsung Electronics Co., Ltd., Samsung Electronics America, Inc., LG Electronics Inc. and LG Electronics U.S.A., Inc. in the United States District Court in the District of Delaware, alleging infringement of three United States Patents (the “Cresta Patents”). The Delaware District Court action has been stayed.

On January 28, 2014, Cresta Technology also filed a complaint with the United States International Trade Commission (“ITC”) alleging infringement of the same patents. On September 29, 2015, the ITC issued its Final Determination, finding that all the patent claims asserted against the Company’s products were either invalid or not infringed and that Cresta Technology failed to establish the ITC’s domestic industry requirement. The ITC found no violation by the Company and terminated the investigation. On November 30, 2015, Cresta Technology filed an appeal of the ITC decision to the Federal Circuit. On March 8, 2016, pursuant to a stipulated dismissal, the Federal Circuit dismissed Cresta Technology’s appeal in its entirety.

In a parallel process, the Company challenged the validity of the claims of the Cresta Patents asserted in the ITC investigation through a series of *Inter-Partes* Review (IPR) proceedings at the Patent Trial and Appeal Board (PTAB) of the United States Patent and Trademark Office (USPTO). On October 21, 2015, the USPTO issued final written decisions on a first set of reviewed claims finding all of the reviewed claims invalid. On December 18, 2015, Cresta Technology appealed those adverse decisions to the United States Court of Appeals for the Federal Circuit as to this first USPTO determination. The Federal Circuit summarily affirmed the USPTO’s first determination on November 8, 2016 and the mandate issued on December 16, 2016, rendering the USPTO’s determination final.

The USPTO instituted a second set of IPR proceedings against a second set of the remaining claims. On August 11, 2016, the PTAB issued its final written decisions in these proceedings and found all of these remaining claims unpatentable. On October 13, 2016, the patent owner, now known as CF Crespe LLC, filed a notice of appeal with the Federal Circuit seeking to overturn the USPTO’s

Silicon Laboratories Inc.
Notes to Consolidated Financial Statements
December 31, 2016 (Continued)

14. Commitments and Contingencies (Continued)

final written decision as to a subset of the claims found unpatentable in this second set of IPR proceedings. That appeal is currently in briefing. No hearing date has been set.

On March 18, 2016, Cresta Technology filed for chapter 7 bankruptcy in the United States Bankruptcy Court for the Northern District of California.

On May 13, 2016, the Bankruptcy Court approved an agreement for DBD Credit Funding LLC (“DBD”) to buy Cresta Technology’s entire IP portfolio and certain related litigation. Following that sale, DBD (through an apparent assignee, CF Crespe LLC) has substituted in the Delaware District Court action, the appeal proceedings at the U.S. Court of Appeals for the Federal Circuit for the first set of IPR proceedings and the USPTO PTAB proceedings for the second set of IPRs replacing Cresta Technology.

On July 16, 2014, the Company filed a lawsuit against Cresta Technology in the United States District Court in the Northern District of California alleging infringement of six United States Patents. The Company is seeking a permanent injunction and an award of damages and attorney fees. As a result of the chapter 7 bankruptcy filing by Cresta Technology, these proceedings were stayed. However, as a result of the May 13, 2016 sale order by the Bankruptcy Court, DBD and CF Crespe LLC were ordered to substitute in as Defendant for Cresta Technology. DBD and CF Crespe LLC have appealed the Bankruptcy Court’s order in that regard. Subject to that appeal, the Company’s patent infringement trial against DBD and CF Crespe LLC is set to begin October 2, 2017.

As is customary in the semiconductor industry, the Company provides indemnification protection to its customers for intellectual property claims related to the Company’s products. The Company has not accrued any material liability on its Consolidated Balance Sheet related to such indemnification obligations in connection with the Cresta Technology litigation.

The Company intends to continue to vigorously defend against Cresta Technology’s (now DBD and CF Crespe LLC’s) allegations and to continue to pursue its claims against Cresta and their patents. At this time, the Company cannot predict the outcome of these matters or the resulting financial impact to it, if any.

Other

The Company is involved in various other legal proceedings that have arisen in the normal course of business. While the ultimate results of these matters cannot be predicted with certainty, the Company does not expect them to have a material adverse effect on its Consolidated Financial Statements.

15. Related Party Transactions

In August 2016, Bill Bock, a member of the Company’s board of directors, joined the board of directors of Spredfast. Spredfast has been a tenant in one of the buildings at the Company’s headquarters in Austin, Texas since May 2013. During fiscal 2016, 2015 and 2014, the Company received payments from Spredfast of \$3.2 million, \$2.5 million and \$1.6 million, respectively, in connection with the leased facilities.

Silicon Laboratories Inc.
Notes to Consolidated Financial Statements
December 31, 2016 (Continued)

15. Related Party Transactions (Continued)

On July 1, 2013, Geir Førre joined the Company as senior vice president. Mr. Førre was chief executive officer of Energy Micro, until it was acquired by the Company. Mr. Førre was the beneficial owner of approximately 30% of the Energy Micro equity and accordingly received approximately \$35 million at closing. In the first quarter of 2015, Mr. Førre received approximately \$6.1 million of the \$20.0 million paid for the holdback related to potential indemnification claims and approximately \$1.9 million of the \$6.3 million paid for the fiscal 2014 earn-out. On March 11, 2016, the Company entered into an agreement which settled the amount of the earn-out to be paid for fiscal 2015 through 2018. Under this agreement, Mr. Førre received approximately \$4.8 million of the \$16.0 million that was paid.

Alf-Egil Bogen served on the Company's board of directors from October 17, 2013 to April 21, 2016. Mr. Bogen was chief marketing officer of Energy Micro, until it was acquired by the Company. Mr. Bogen was the beneficial owner of approximately 2% of the Energy Micro equity and accordingly received approximately \$0.9 million at closing. In the first quarter of 2015, Mr. Bogen received approximately \$0.4 million of the \$20.0 million paid for the holdback related to potential indemnification claims and approximately \$0.1 million of the \$6.3 million paid for the fiscal 2014 earn-out. Under the settlement agreement, Mr. Bogen received approximately \$0.3 million of the \$16.0 million that was paid for fiscal 2015 through 2018 earn-out. Mr. Bogen had invested approximately \$0.8 million in Energy Micro prior to the acquisition.

16. Income Taxes

Income before income taxes includes the following components (in thousands):

	Year Ended		
	December 31, 2016	January 2, 2016	January 3, 2015
Domestic	\$ 4,313	\$ 2,249	\$38,174
Foreign	60,183	28,014	10,866
	<u>\$64,496</u>	<u>\$30,263</u>	<u>\$49,040</u>

The provision for income taxes consists of the following (in thousands):

	Year Ended		
	December 31, 2016	January 2, 2016	January 3, 2015
Current:			
Domestic	\$ 2,639	\$ 951	\$ 7,083
International	4,421	3,015	882
Total Current	7,060	3,966	7,965
Deferred:			
Domestic	(2,430)	(5,825)	2,352
International	(1,628)	2,536	702
Total Deferred	(4,058)	(3,289)	3,054
Provision for income taxes	<u>\$ 3,002</u>	<u>\$ 677</u>	<u>\$11,019</u>

Silicon Laboratories Inc.
Notes to Consolidated Financial Statements
December 31, 2016 (Continued)

16. Income Taxes (Continued)

The reconciliation of the federal statutory tax rate to the Company's effective tax rate is as follows:

	Year Ended		
	December 31, 2016	January 2, 2016	January 3, 2015
Federal statutory rate	35.0%	35.0%	35.0%
Foreign tax rate benefit	(27.2)	(30.7)	(3.5)
Research and development tax credits	(4.1)	(5.6)	(8.6)
Release of prior year unrecognized tax benefits . .	(1.7)	(1.9)	(2.6)
Excess officer compensation	1.4	3.2	2.3
Change in cost-sharing treatment of stock-based compensation	(0.5)	(7.1)	—
Change in prior period valuation allowance	(0.6)	8.8	(1.4)
Other	2.4	0.5	1.3
Effective Tax Rate	4.7%	2.2%	22.5%

The effective tax rate for fiscal 2016 increased from fiscal 2015 primarily due to fiscal 2015 including a net benefit from a change in the tax accounting treatment of stock-based compensation in a cost-sharing arrangement following a U.S. Tax Court case (Altera). The increase in the effective tax rate was offset by a reduction in the prior period valuation allowance.

The effective tax rate for fiscal 2015 decreased from fiscal 2014, primarily due to the completion of payments related to a prior year intercompany licensing arrangement as well as the recognition of a net benefit from a change in the tax accounting treatment of stock-based compensation in a cost-sharing arrangement following a U.S. Tax Court case (Altera). The decrease in the effective tax rate during fiscal 2015 was offset by an increase in the prior year valuation allowance related to lower expectations of profitability in jurisdictions where tax attributes exist.

On July 27, 2015, the U.S. Tax Court (the "Court") issued an opinion in *Altera Corp. v. Commissioner* related to the treatment of stock-based compensation expense in an intercompany cost-sharing arrangement. A final decision was entered by the Court on December 1, 2015. In its opinion, the Court accepted Altera's position of excluding stock-based compensation from its cost-sharing arrangement and concluded that the related U.S. Treasury Regulations were invalid. In February 2016, the U.S. Internal Revenue Service (the "IRS") appealed the decision to the U.S. Court of Appeals for the Ninth Circuit. Although the IRS has appealed the decision, and the U.S. Treasury has not withdrawn the requirement to include stock-based compensation from its regulations, based on the facts and circumstances of the Tax Court Case, the Company believes that it is more likely than not that the Tax Court decision will be upheld and has recognized a benefit in its financial statements of \$33.1 million. This change to cost-sharing is expected to increase the Company's cumulative foreign earnings at the time of final resolution of the case. As such, the Company has accrued a deferred tax liability of \$31.2 million for the U.S. tax cost of potential repatriation of the associated foreign earnings because at this time, the Company cannot reasonably conclude that it will have the ability and intent to indefinitely reinvest these contingent earnings. The Company will continue to monitor ongoing developments and potential impacts to its Consolidated Financial Statements.

Silicon Laboratories Inc.
Notes to Consolidated Financial Statements
December 31, 2016 (Continued)

16. Income Taxes (Continued)

The Company's operations in Singapore are subject to reduced tax rates through June 30, 2019, as long as certain conditions are met. The income tax benefit from the reduced Singapore tax rate reflected in earnings was approximately \$7.7 million (representing \$0.18 per diluted share) in fiscal 2016, approximately \$14.4 million (representing \$0.34 per diluted share) in fiscal 2015 and approximately \$2.0 million (representing \$0.05 per diluted share) in fiscal 2014.

At the end of fiscal 2016, undistributed earnings of the Company's foreign subsidiaries of approximately \$361.4 million are intended to be permanently reinvested outside the U.S. Accordingly, no provision for U.S. federal and state income taxes associated with a distribution of these earnings has been made. Determination of the amount of the unrecognized deferred tax liability on these unremitted earnings is not practicable.

Deferred Income Taxes

Deferred tax assets and liabilities are recorded for the estimated tax impact of temporary differences between the tax basis and book basis of assets and liabilities. Significant components of the Company's deferred taxes as of December 31, 2016 and January 2, 2016 are as follows (in thousands):

	<u>December 31, 2016</u>	<u>January 2, 2016</u>
Deferred tax assets:		
Net operating loss carryforwards	\$ 21,187	\$ 25,869
Research and development tax credit carryforwards	15,068	13,335
Stock-based compensation	7,396	8,757
Capitalized research and development	6,802	8,741
Deferred income on shipments to distributors	9,338	7,413
Expected future cost-sharing adjustment	29,719	25,896
Accrued liabilities and other	11,321	8,619
	<u>100,831</u>	<u>98,630</u>
Less: Valuation allowance	<u>(12,361)</u>	<u>(10,264)</u>
	88,470	88,366
Deferred tax liabilities:		
Acquired intangible assets	25,785	33,020
Depreciation and amortization	2,939	2,349
Unremitted foreign earnings for expected future cost-sharing adjustment	31,165	27,495
Prepaid expenses and other	3,069	1,991
	<u>62,958</u>	<u>64,855</u>
Net deferred tax assets	<u>\$ 25,512</u>	<u>\$ 23,511</u>

As of December 31, 2016, the Company had federal net operating loss and research and development tax credit carryforwards of approximately \$44.5 million and \$1.9 million, respectively, as a result of the Silicon Clocks, Spectra Linear and Ember acquisitions. These carryforwards expire in fiscal years 2021 through 2032. Recognition of these loss and credit carryforwards is subject to an annual

Silicon Laboratories Inc.
Notes to Consolidated Financial Statements
December 31, 2016 (Continued)

16. Income Taxes (Continued)

limit, which may cause them to expire before they are used. Additionally, as of December 31, 2016, the Company had generated \$7.4 million of federal research and development tax credit carryforwards. These carryforwards will begin expiring in 2036.

As of December 31, 2016, the Company had foreign net operating loss carryforwards of approximately \$13.2 million as a result of the Energy Micro acquisition. These loss carryforwards do not expire and recognition is not subject to an annual limit.

The Company also had state loss and research and development tax credit carryforwards of approximately \$49.1 million and \$13.1 million, respectively. A portion of these loss and credit carryforwards was generated by the Company and a portion was acquired through the Integration Associates, Silicon Clocks, Spectra Linear and Ember acquisitions. Certain of these carryforwards expire in fiscal years 2017 through 2033, and others do not expire. Recognition of some of these loss and credit carryforwards is subject to an annual limit, which may cause them to expire before they are used.

A valuation allowance is established against a deferred tax asset when it is more likely than not that the deferred tax asset will not be realized. As of December 31, 2016, the Company maintains a valuation allowance with respect to certain deferred tax assets relating primarily to U.S. federal and state research and development tax credit carryforwards.

Uncertain Tax Positions

The following table summarizes the activity related to gross unrecognized tax benefits (in thousands):

	Year Ended		
	December 31, 2016	January 2, 2016	January 3, 2015
Beginning balance	\$ 3,610	\$3,929	\$ 4,998
Additions based on tax positions related to current year	439	432	465
Additions based on tax positions related to prior years	99	—	58
Reductions for tax positions as a result of a lapse of the applicable statute of limitations	(1,094)	(751)	(1,592)
Ending balance	<u>\$ 3,054</u>	<u>\$3,610</u>	<u>\$ 3,929</u>

As of December 31, 2016, January 2, 2016 and January 3, 2015, the Company had gross unrecognized tax benefits of \$3.0 million, \$3.6 million and \$3.9 million, respectively, of which \$2.2 million, \$3.2 million and \$4.0 million, respectively, would affect the effective tax rate if recognized.

The Company recognizes interest and penalties related to unrecognized tax benefits in the provision for income taxes. These amounts were not material for fiscal years 2016, 2015 and 2014.

Tax years 2012 through 2016 remain open to examination by the major taxing jurisdictions to which the Company is subject. The Company is not currently under audit in any major taxing jurisdiction.

Silicon Laboratories Inc.
Notes to Consolidated Financial Statements
December 31, 2016 (Continued)

16. Income Taxes (Continued)

Although the timing of resolution, settlement and closures of audits is not certain, the Company does not expect the gross unrecognized tax benefits to materially change in the next 12 months.

17. Segment Information

The Company has one operating segment, mixed-signal analog intensive products, consisting of numerous product areas. The Company's chief operating decision maker is considered to be its Chief Executive Officer. The chief operating decision maker allocates resources and assesses performance of the business and other activities at the operating segment level.

The Company groups its products into four categories, based on the markets and applications in which its ICs may be used. The following summarizes the Company's revenue by product category (in thousands):

	Year Ended		
	December 31, 2016	January 2, 2016	January 3, 2015
Internet of Things	\$314,614	\$262,329	\$209,005
Broadcast	157,746	161,787	204,256
Infrastructure	147,677	121,974	108,123
Access	77,589	98,736	99,320
Total	<u>\$697,626</u>	<u>\$644,826</u>	<u>\$620,704</u>

Revenue is attributed to a geographic area based on the shipped-to location. The following summarizes the Company's revenue by geographic area (in thousands):

	Year Ended		
	December 31, 2016	January 2, 2016	January 3, 2015
United States	\$ 94,583	\$ 96,959	\$ 89,935
China	291,974	281,306	271,818
Rest of world	311,069	266,561	258,951
Total	<u>\$697,626</u>	<u>\$644,826</u>	<u>\$620,704</u>

The following summarizes the Company's property and equipment, net by geographic area (in thousands):

	December 31, 2016	January 2, 2016
United States	\$124,163	\$126,404
Rest of world	5,396	4,728
Total	<u>\$129,559</u>	<u>\$131,132</u>

Silicon Laboratories Inc.
Notes to Consolidated Financial Statements
December 31, 2016 (Continued)

18. Subsequent Event

Acquisition

On January 20, 2017, the Company acquired Zentri, Inc., a private company. Zentri is an innovator in low-power, cloud-connected Wi-Fi technologies for the IoT. The Company acquired Zentri for: 1) initial cash consideration of \$15.5 million adjusted for an amount equal to: a) certain Zentri liabilities as of the closing date, b) Zentri transaction expenses, and c) the aggregate exercise price of all vested options for which the per common share closing consideration exceeds the per share exercise price for such vested options, and 2) potential additional consideration of up to approximately \$10.0 million payable based on fiscal 2017 revenue from certain Zentri products.

The Company will record the purchase of Zentri using the acquisition method of accounting and will recognize the assets acquired and liabilities assumed at their fair values as of the date of the acquisition. The results of Zentri's operations will be included in the Company's consolidated results of operations beginning on the date of the acquisition.

The Company is currently evaluating the fair values of the consideration transferred, assets acquired and liabilities assumed. The Company expects to complete its initial purchase price allocation in the first quarter of fiscal 2017.

Supplementary Financial Information (Unaudited)

Quarterly financial information for fiscal 2016 and 2015 is as follows. All quarterly periods reported here had 13 weeks (in thousands, except per share amounts):

	Fiscal 2016			
	Fourth Quarter	Third Quarter	Second Quarter	First Quarter
Revenues	\$182,610	\$178,083	\$174,908	\$162,025
Gross margin	109,476	108,203	108,294	95,531
Operating income	20,083	21,732	17,614	6,848
Net income	\$ 20,109	\$ 20,018	\$ 15,559	\$ 5,808
Earnings per share:				
Basic	\$ 0.48	\$ 0.48	\$ 0.37	\$ 0.14
Diluted	\$ 0.47	\$ 0.47	\$ 0.37	\$ 0.14
	Fiscal 2015			
	Fourth Quarter	Third Quarter	Second Quarter	First Quarter
Revenues	\$160,071	\$156,194	\$164,856	\$163,705
Gross margin	93,538	93,435	97,428	96,369
Operating income	4,796	11,223	9,003	7,212
Net income	\$ 5,658	\$ 9,975	\$ 7,575	\$ 6,378
Earnings per share:				
Basic	\$ 0.14	\$ 0.24	\$ 0.18	\$ 0.15
Diluted	\$ 0.13	\$ 0.23	\$ 0.17	\$ 0.15

**Supplementary Financial Information
to the Annual Report**

**Appendix I. Reconciliation of GAAP
to Non-GAAP Financial Measures**

(This page has been left blank intentionally.)

Appendix I: Supplemental Financial Information (Unaudited)

The non-GAAP financial measurements provided below do not replace the presentation of Silicon Laboratories' GAAP financial results. These measurements merely provide supplemental information to assist investors in analyzing Silicon Laboratories' financial position and results of operations; however, these measures are not in accordance with, or an alternative to, GAAP and may be different from non-GAAP measures used by other companies. We are providing this information because it may enable investors to perform meaningful comparisons of operating results, and more clearly highlight the results of core ongoing operations.

Unaudited Reconciliation of GAAP to Non-GAAP Financial Measures (In thousands, except per share data)

Non-GAAP Income Statement Items	Year Ended December 31, 2016								
	GAAP Measure	GAAP Percent of Revenue	Stock Compensation Expense*	Intangible Asset Amortization*	Acquisition Related Items*	Termination Costs*	Income Tax Adjustments	Non-GAAP Measure	Non-GAAP Percent of Revenue
Revenues	\$697,626								
Gross margin	421,504	60.4%	\$ 1,070	\$ 909	\$ 427	\$ —	\$ —	\$423,910	60.8%
Research and development	199,744	28.6%	19,573	20,090	(231)	236	—	160,076	22.9%
Selling, general and administrative	155,483	22.3%	18,985	5,780	569	1,460	—	128,689	18.5%
Operating expenses	355,227	50.9%	38,558	25,870	337	1,697	—	288,765	41.4%
Operating income	66,277	9.5%	39,628	26,779	764	1,697	—	135,145	19.4%
Net income	61,494	8.8%	39,628	26,779	764	1,697	(12,716)	117,646	16.9%
Diluted shares outstanding	42,376		—	—	—	—	—	42,376	
Diluted earnings per share	\$ 1.45							\$ 2.78	

* Represents pre-tax amounts

Unaudited Reconciliation of GAAP to Non-GAAP Financial Measures
(In thousands, except per share data)
(Continued)

Non-GAAP Income Statement Items	Three Months Ended December 31, 2016								
	GAAP Measure	GAAP Percent of Revenue	Stock Compensation Expense*	Intangible Asset Amortization*	Acquisition Related Items*	Termination Costs*	Income Tax Adjustments	Non-GAAP Measure	Non-GAAP Percent of Revenue
Revenues	\$182,610								
Gross margin	109,476	60.0%	\$ 264	\$ —	\$ —	\$ —	\$ —	\$109,740	60.1%
Research and development	50,626	27.7%	4,879	4,601	(232)	—	—	41,378	22.7%
Selling, general and administrative	38,767	21.3%	4,429	1,522	282	742	—	31,792	17.4%
Operating expenses	89,393	49.0%	9,308	6,123	50	742	—	73,170	40.1%
Operating income	20,083	11.0%	9,572	6,123	50	742	—	36,570	20.0%
Net income	20,109	11.0%	9,572	6,123	50	742	(4,585)	32,011	17.5%
Diluted shares outstanding	42,728		—	—	—	—	—	42,728	
Diluted earnings per share	\$ 0.47							\$ 0.75	

* Represents pre-tax amounts

Non-GAAP Income Statement Items	Three Months Ended October 1, 2016								
	GAAP Measure	GAAP Percent of Revenue	Stock Compensation Expense*	Intangible Asset Amortization*	Acquisition Related Items*	Termination Costs*	Income Tax Adjustments	Non-GAAP Measure	Non-GAAP Percent of Revenue
Revenues	\$178,083								
Gross margin	108,203	60.8%	\$ 272	\$ 130	\$ —	\$ —	\$ —	\$108,605	61.0%
Research and development	48,437	27.2%	4,580	4,257	—	—	—	39,600	22.2%
Selling, general and administrative	38,034	21.4%	4,343	1,420	311	552	—	31,408	17.7%
Operating expenses	86,471	48.6%	8,923	5,677	311	552	—	71,008	39.9%
Operating income	21,732	12.2%	9,195	5,807	311	552	—	37,597	21.1%
Net income	20,018	11.2%	9,195	5,807	311	552	(3,467)	32,416	18.2%
Diluted shares outstanding	42,307		—	—	—	—	—	42,307	
Diluted earnings per share	\$ 0.47							\$ 0.77	

* Represents pre-tax amounts

Unaudited Reconciliation of GAAP to Non-GAAP Financial Measures
(In thousands, except per share data)
(Continued)

Non-GAAP Income Statement Items	Three Months Ended July 2, 2016								
	GAAP Measure	GAAP Percent of Revenue	Stock Compensation Expense*	Intangible Asset Amortization*	Acquisition Related Items*	Termination Costs*	Income Tax Adjustments	Non-GAAP Measure	Non-GAAP Percent of Revenue
Revenues	\$174,908								
Gross margin	108,294	61.9%	\$ 269	\$ 389	\$—	\$ —	\$ —	\$108,952	62.3%
Research and development	51,635	29.5%	5,205	5,616	—	236	—	40,578	23.2%
Selling, general and administrative	39,045	22.3%	5,044	1,419	—	63	—	32,519	18.6%
Operating expenses	90,680	51.8%	10,249	7,035	—	299	—	73,097	41.8%
Operating income	17,614	10.1%	10,518	7,424	—	299	—	35,855	20.5%
Net income	15,559	8.9%	10,518	7,424	—	299	(2,046)	31,754	18.2%
Diluted shares outstanding	42,284		—	—	—	—	—	42,284	
Diluted earnings per share	\$ 0.37							\$ 0.75	

* Represents pre-tax amounts

Non-GAAP Income Statement Items	Three Months Ended April 2, 2016								
	GAAP Measure	GAAP Percent of Revenue	Stock Compensation Expense*	Intangible Asset Amortization*	Acquisition Related Items*	Termination Costs*	Income Tax Adjustments	Non-GAAP Measure	Non-GAAP Percent of Revenue
Revenues	\$162,025								
Gross margin	95,531	59.0%	\$ 266	\$ 390	\$426	\$ —	\$ —	\$96,613	59.6%
Research and development	49,046	30.3%	4,910	5,616	—	—	—	38,520	23.8%
Selling, general and administrative	39,637	24.5%	5,168	1,419	(24)	104	—	32,970	20.3%
Operating expenses	88,683	54.8%	10,078	7,035	(24)	104	—	71,490	44.1%
Operating income	6,848	4.2%	10,344	7,425	402	104	—	25,123	15.5%
Net income	5,808	3.6%	10,344	7,425	402	104	(2,618)	21,465	13.2%
Diluted shares outstanding	42,199		—	—	—	—	—	42,199	
Diluted earnings per share	\$ 0.14							\$ 0.51	

* Represents pre-tax amounts

(This page has been left blank intentionally.)

Silicon Labs makes silicon, software and solutions for a more connected world.

Founded in 1996 and headquartered in Austin, Texas, Silicon Labs has more than 1,500 patents issued or pending. The company's common stock is traded on the NASDAQ exchange under the ticker symbol "SLAB."

Board of Directors

Nav S. Sooch

Chief Executive Officer,
Ketra

Tyson Tuttle

President and
Chief Executive Officer,
Silicon Labs

Bill Bock

Former President, Silicon Labs

Neil Kim

Former Executive Vice President
of Operations and Central
Engineering, Broadcom

Jack Lazar

Former CFO, Go Pro

Nina Richardson

Managing Director,
Three Rivers Energy

Sumit Sadana

Former Executive Vice President,
Chief Strategy Officer and General
Manager of Enterprise Solutions,
Sandisk

Bill Wood

General Partner,
Silverton Partners

Executive Officers

Tyson Tuttle

President and
Chief Executive Officer

John Hollister

Senior Vice President and
Chief Financial Officer

Brandon Tolany

Senior Vice President of
Worldwide Sales

Sandeep Kumar, PhD

Senior Vice President
of Worldwide Operations

Corporate Information

Stock Listing

Common stock traded on
NASDAQ, symbol SLAB

Options

The Company's options are traded
on the Chicago Board Option
Exchange and the American
Stock Exchange.

Legal Counsel

DLA Piper US LLP
401 Congress Avenue,
Suite 2500
Austin, Texas, 78701 USA

Independent Registered Public Accounting Firm

Ernst & Young LLP
401 Congress Avenue,
Suite 1800
Austin, Texas, 78701 USA

Transfer Agent and Registrar

American Stock Transfer &
Trust Company
59 Maiden Lane
Plaza Level
New York, New York, 10038 USA
+1 800-937-5449

Stock Data

As of 1/23/2017, there were 85
holders of record, holding a total
of 41,890,791 shares. The table
below shows the high and low per-
share sales prices of our common
stock for the periods indicated, as
reported by NASDAQ.

	High	Low
Q1	\$48.00	\$36.56
Q2	\$51.00	\$42.63
Q3	\$59.35	\$45.94
Q4	\$68.95	\$55.97

Annual Meeting

The Silicon Laboratories Inc.
annual meeting will be held on
Thursday, April 20, 2017 at 9:30
a.m. Central Time at the Lady Bird
Johnson Wildflower Center,
4801 La Crosse Avenue,
Austin, Texas, 78739 USA

Investor Relations

For more information about
Silicon Labs, please visit our
website at www.silabs.com, or
contact:

Investor Relations
Silicon Labs
400 West Cesar Chavez Street
Austin, Texas, 78701 USA
+1 512-416-8500
investor.relations@silabs.com



Silicon, software and solutions for a smarter, more connected world.