

# CYPRESS

## 2 0 1 2 A N N U A L R E P O R T

### 30 YEARS OF INNOVATION

Cypress celebrated its 30th birthday on December 1, 2012 with the launch of its most important chip ever.

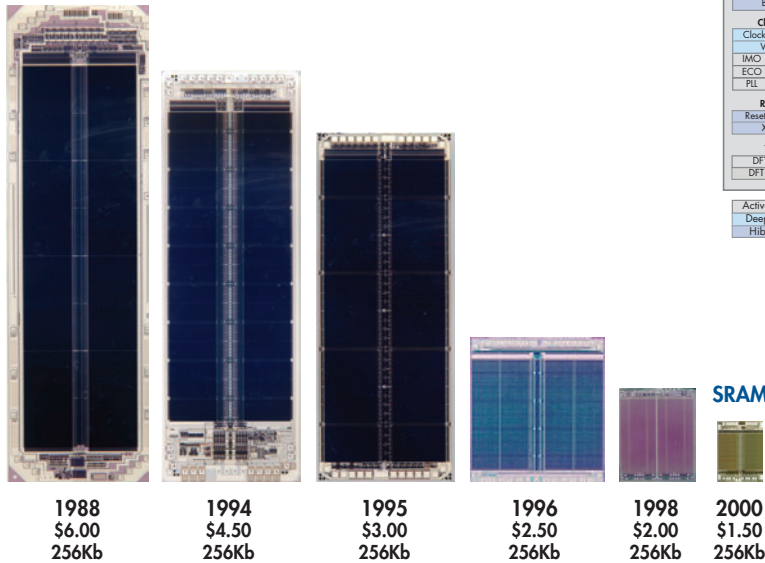

### PSoC® 4 Is Here!

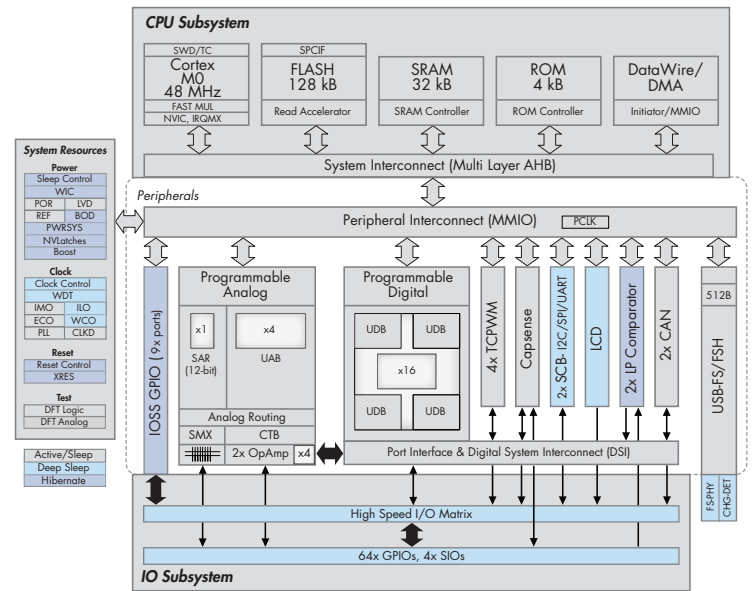

- PSoc 4**
- 2013**  
**\$1.00**  
**32-bit ARM CPU**  
 32 Kb SRAM  
 256 Kb Flash  
 32 Kb ROM
- Programmable IP**
- 1 CapSense Block (36 buttons)
  - 2 Programmable IDACs
  - 2 Serial Communications Blocks
  - 4 Timer-Counter Pulse-Width Modulators
  - 2 Low Power Analog Comparators
- Programmable Analog**
- 12-bit SAR ADC
  - Continuous-Time Block w/2 OpAmps
- Programmable Digital**
- 4x Universal Digital Blocks each w/2 PLDs and 1 datapath
- Programmable I/O**
- High-speed IO Matrix
  - 36 Programmable General Purpose IOs
  - 2 Analog/Mux Buses in all GPIOs

**Cypress Transformation—From Chips to Solutions:** As an SRAM company, founded in 1982, our objective was follow Moore's Law to reduce chip size, lower device cost and increase performance. The photos above show six generations of our 256-Kilobit (Kb) SRAM chip—designed on increasingly smaller geometries—alongside our new PSoc 4 programmable system-on-chip, which contains 32 Kb of SRAM, and a lot more, as the list of circuit blocks shows. PSoc 4 integrates our programmable analog technology; our flexible, programmable digital logic; SRAM and Flash memory; and an ARM® Cortex™-M0 microcontroller core—all on a tiny chip. All for \$1.



# PSoC® 4, PSoC CREATOR™ AND PSoC COMPONENTS™: A POWERFUL, NEW DESIGN PLATFORM

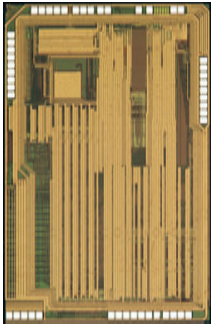

PSoC 4: The world's most flexible, lowest-power ARM Cortex-M0-based device for \$1.

Imagine if you could get an entire mixed-signal embedded system chip with an ARM® 32-bit processor for \$1. Cypress's new PSoC 4 programmable system-on-chip architecture combines our programmable precision analog circuitry, programmable digital blocks, and fully-routable I/Os, with our CapSense® capacitive touch technology and ARM's power-efficient Cortex™-M0 core.

PSoC 4 enables design engineers to leverage ARM's low-cost cores, which account for an increasing share of the MCU market, along with a wealth of programmable elements, to enable complete system design—all for \$1.

Our PSoC Creator platform system design software features pre-verified, production-ready PSoC Components, virtual chips within PSoC 4 that replace and integrate multiple competitor chips to create custom solutions. Our solution—PSoC 4, PSoC Components and PSoC Creator, our highly-rated development platform—simplifies and accelerates the design process, reduces BOM, and enables our customers to change their hardware as easily and rapidly as they change their firmware.

*“Can life get simpler? PSoC and PSoC Creator greatly simplify the setup and configuration process in embedded designs. The drag-and-drop approach to system components enables engineers to connect functional hardware and software at the block-diagram level. Bravo, Cypress.”*

— Jon Titus, leading electronics journalist, designer of the Mark-8 PC prototype in the Smithsonian Institution

## FOUR DESIGN STEPS TO A RELIABLE, INTEGRATED PSoC SOLUTION

**1** A COMPLEX CAPSENSE DESIGN IN CHALLENGING ENVIRONMENTS...



Wet environments  
Curved and thick overlays

**2** IS QUICKLY AND SIMPLY DESIGNED IN OUR PSoC CREATOR DESIGN ENVIRONMENT WITH PRODUCTION-READY CAPSENSE COMPONENTS...

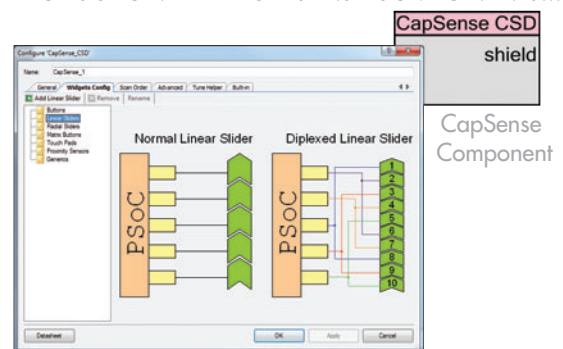

Embedded Component Configuration Tool

**3** INTEGRATED WITH OTHER SYSTEM FUNCTIONS ON A SINGLE PSoC 4 CHIP...

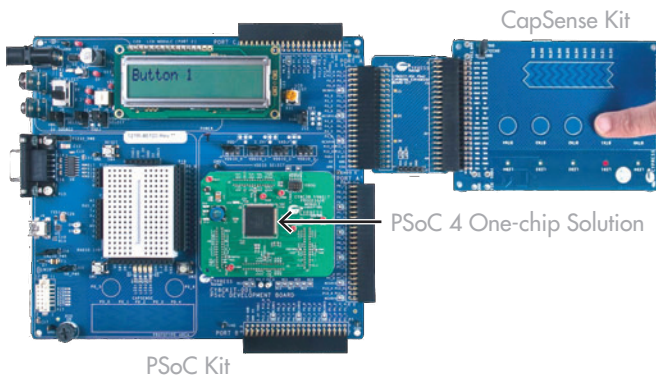

PSoC Kit

**4** TO CREATE A RELIABLE, ONE-CHIP SOLUTION FOR A SLEEK, WATERPROOF INTERFACE.



## FELLOW SHAREHOLDERS: \*

### INTRODUCTION

In last year's Annual Report, I made some statements that look reasonable one year later, such as, "We have increased our dividend to \$0.44 per year, making Cypress stock an attractive investment that can provide a reasonable return, even during semiconductor dips." Other statements of mine did not age well over the year, for example:

"We believe Cypress has become an attractive equity-only investment."

"We expect PSoC<sup>®</sup> to grow more modestly in 2012."

And, finally, "TrueTouch<sup>®</sup> revenue will hold the high-water mark achieved in 2011 with a new chip only engineers could have named: Touch Screen Generation 4, or TSG4."

The realities of 2012 turned out to be contrary to the statements above. The TSG4 chip did not ramp into production quickly enough to replace our blockbuster TSG3 chip, causing our touchscreen revenue to drop \$103 million year-on-year. PSoC revenue dropped accordingly. Combined with a significant slowdown in the Static Random Access Memory (SRAM) market, the TSG4 problem led to declines in 2012 revenue (\$995 million to \$770 million), EPS (\$1.25 to \$0.55), and consequently share price (\$16.89 to \$10.50). Thus, Cypress was not an attractive equity investment in 2012.

The TSG4 problem exposed a fundamental weakness in our software development organization that delayed our TSG4 entry into the market by six months, long enough to lose almost all the TSG4 revenue in our 2012 operating plan. The software development problem has been rectified by a major reorganization that appears to be working: Our next-generation TSG5 chip is already in the market with software that was ready when the chip came out.

We have been fighting a long-term SRAM Total Available Market (TAM) decline for over a decade. The resulting SRAM-based revenue decline has been offset by the rapid revenue growth of our Programmable System-on-Chip (PSoC) product family, but that balance has held our total revenue flat since 2003. We

expect the SRAM TAM to finally bottom out over the next two to three years, allowing undiminished PSoC growth to show up on the top line.

This report provides details on our finances, the PSoC story along with the TSG4 problem and its correction, an analysis of our long-term performance in the SRAM market, and metrics on shareholder value creation.

### FINANCIALS

Cypress's revenue over the last four years is shown in *Figure 1*. Our 2012 revenue declined year-on-year in each quarter in a poor semiconductor market, but we improved on our performance in the poor market of 2009 and remained profitable in every quarter of 2012.

#### REVENUE AND PROFIT BEFORE TAX

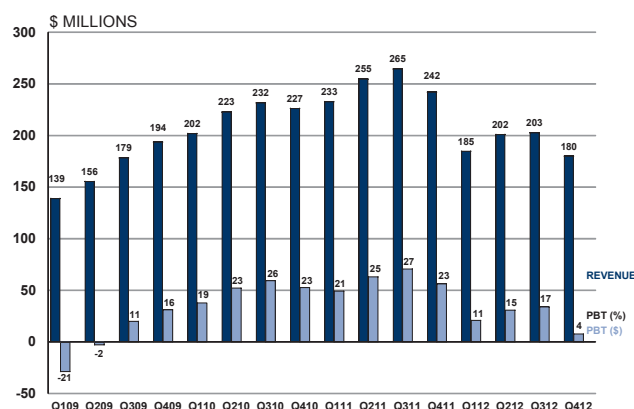
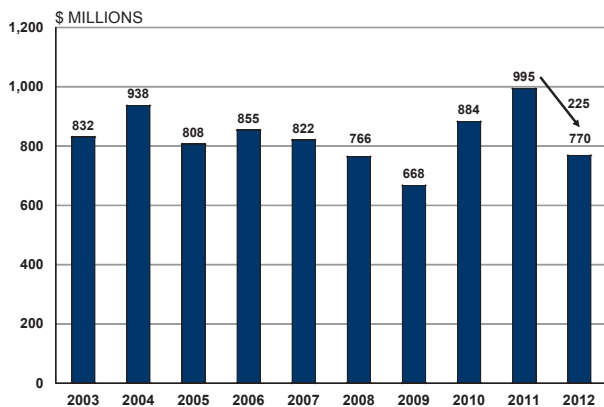

**Figure 1.** Cypress's 2009-2012 quarterly revenue trend showed a year-long revenue decline in 2012. The company did remain profitable in every quarter and averaged 12.2% profit before taxes (PBT) for the year. During the last semiconductor recession, which bottomed in Q1 2009, Cypress's revenue dipped to \$139 million, leading to a 21% loss. We are performing better in this downturn. **(This report is designed so that the reader can go through only the figures and captions and understand a majority of its content.)**

Cypress's annual revenue trend (*Figure 2*) shows a \$225 million decline in revenue from \$995 million in 2011 to \$770 million in 2012. The biggest contributor to our year-on-year revenue decline was a drop in our touchscreen chip revenue (\$103 million), which was caused partly by the delayed launch of our TSG4 chip, and partly by some major end-customer implosions. An execution problem that will be described later delayed the TSG4 software by six months—an eternity in that fast-moving market.

\* This report is designed so the reader can go through only the figures and captions and understand a majority of its content.

## REVENUE



**Figure 2.** Cypress’s 2012 revenue dropped \$225 million to \$770 million vs. \$995 million in 2011. The root causes of this revenue drop were (in order of importance): first, a loss of market share in cell-phone touchscreen chips discussed in the body of this report (\$103 million); second, a general semiconductor market decline (\$67 million); and third, a significant decline in the Static Random Access Memory (SRAM) market (\$55 million). Over the last decade, Cypress’s revenue has been flat, averaging \$834 million, with upsides in good years like 2011 and downsides in poor years like 2009. This long-term revenue trend has been driven by a balance between a decline in our SRAM revenue offset by rapid growth in our Programmable System-on-Chip (PSoC) revenue.

The second contributor to our 2012 revenue decline (\$67 million) was a significant semiconductor market contraction of 2.7% during the year.

The third contributor to our revenue decline was a particularly severe 20% contraction in the SRAM market in 2012, which caused our SRAM revenue to drop \$55 million year-on-year, despite our record 39% market share.

In the 2011 Annual Report, I described our frustration in trying to break through the billion-dollar revenue barrier. Another way to model our 2003-2012 revenue trend, shown in *Figure 2*, is as a flat annual revenue of \$834 million with upsides and downsides of as much as \$166 million, based on the market and other conditions. We have launched many revenue initiatives to grow out of this problem.

The invention of PSoC in 2000 by our internal, Seattle-based startup, Cypress Microsystems, has been our most significant effort to reinvent Cypress, the SRAM company. Cypress has also funded other startup companies and business units to create new sources of revenue growth.

For example, we invested in SunPower when it was just a \$2 million company. It propelled our 2008 revenue to \$1.8 billion dollars, but our shareholders wanted to monetize that investment (in retrospect, a great call). We obliged with a \$2.55 billion spinout to shareholders on September 30, 2008 (*Figure 16*). But the “New” Cypress, again a stand-alone chip company, got a lot smaller. Our revenue declined from \$600 million the quarter before the spinout to \$165 million in the quarter after, and our share price dropped from \$35.94 the day before the spinout to a closing price on the day of the spinout of \$5.22—“New” Cypress’s starting point (*Figure 13*).

Our Emerging Technology Division (ETD) consists of four startups that could “move the needle” on Cypress revenue. They are described, along with a graph of ETD revenue, in *Figure 3*. The obvious question about that graph is why did the revenue of our “growth” division, ETD, go down in 2012? We divested Cypress EnviroSystems in 2012, which accounted for some of the decline, but revenue shortfalls from the other ETD businesses were the biggest factor.

At Cypress, we drive the revenue of each of our internal business units daily. Our ETD startups are given more slack than our internal business units so that they can focus on creating new technologies and products. The startups can provide many plausible reasons why their optimistic revenue expectations for 2012 were delayed, such as the precipitous drop in the sales of our Optical Navigation System chips for use as trackballs in Blackberry cell phones. But the main problem was that we did not do a deep, zero-based analysis of the risky revenue streams of our startup companies. This year, after a careful analysis, we are highly confident that our ETD revenue will grow. We will be disappointed if it does not set a revenue record, as projected in *Figure 3*.

Cypress EnviroSystems produced \$2.6 million in revenue in Q1-Q3 of 2012 before being divested. Based on the economics and market acceptance of its energy-saving products—and my experience observing a wave of “green” startups struggle in Silicon Valley—we decided not to continue to invest in it. Our management attention has been shifted to a quiet-phase battery startup, in which we currently hold a minority interest.

## EMERGING TECHNOLOGY DIVISION REVENUE

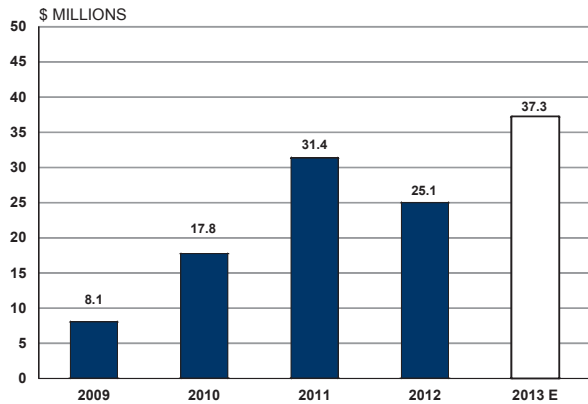

**Figure 3.** The revenue of our Emerging Technology Division, or ETD, dropped to \$25.1 million in 2012. Cypress funds startup companies and business units to enter new markets. These startups include AgigA Tech (very large nonvolatile memories for PC servers), Deca Technologies (chipscale packaging using repurposed SunPower technology), Foundry Services to monetize Cypress's wafer fabrication plant (fab) investments, and Module Solutions (optical navigation and trackpads) for the PC and automotive markets. Cypress EnviroSystems, a "green technology" startup, was divested in 2012. That divestiture accounted for part of the 2012 ETD revenue decline. We have a carefully scrubbed plan to grow to \$37.3 million in ETD revenue for 2013.

I remind investors that startups are exceptionally risky and that, despite our great successes with Cypress Microsystems and SunPower, we have also endured 10 startup failures over the years.

Finally, Cypress acquired Ramtron, the Colorado Springs-based maker of nonvolatile RAMs, to grow the revenue of our Memory Products Division (MPD). We will not report Ramtron revenue separately in the future, but we expect it to be immediately accretive to earnings and to add \$40.9 million in MPD revenue in 2013. That figure will be tracked as a *corporate priority*, meaning that it is one of my formal objectives that is reported quarterly to the Cypress board.

Cypress's gross margin for 2003-2012 is shown in *Figure 4*. Our gross margin in 2012 was 55.4%—in the 55%-59% territory that has defined Cypress since it implemented its fab-lite strategy but down 1.9 percentage points from our 2011 gross margin. This decline is due primarily to the underabsorption of manufacturing overhead caused by lower 2012 revenue.

## GROSS MARGIN

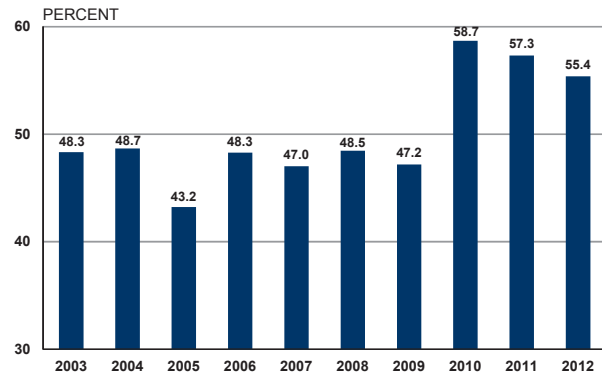

**Figure 4.** Our gross margin ranged from 43% to 49% during the 2003-2009 period, when Cypress built SRAMs in internal fabs and followed Moore's Law. As our new PSoC and fab-lite strategies took over in 2010-2012, our gross margin jumped into the 55%-59% range. Cypress's 2012 gross margin of 55.4% reflected price pressure in a down semiconductor market and underloading in both our wafer fabrication plant (Fab 4 in Minnesota) and our assembly and test plant (CML in Manila).

Cypress's EPS for 2003-2012 is shown in *Figure 5*. Our long-term trend shows an EPS increase of \$0.064 per year, although it is obvious that any single-year EPS may differ wildly from that trend.

### EARNINGS PER SHARE

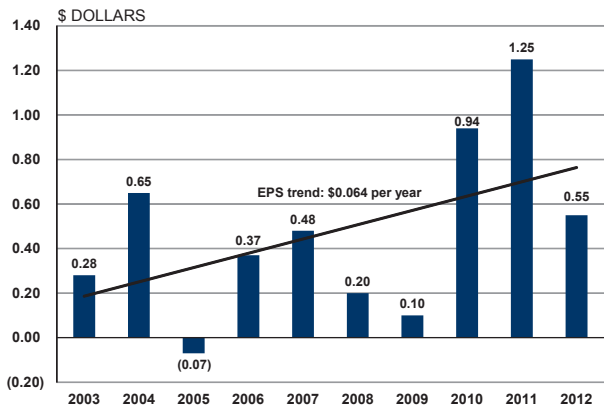

**Figure 5.** Cypress's 2012 EPS was \$0.55, down from our peak EPS of \$1.25 in 2011, due primarily to the 22.7% revenue decline in 2012. The EPS decline was mitigated significantly (about \$0.26) by our 2012 World Class Cost (WCC) cost-cutting program described in detail in the body of this report. The EPS trend line for 2003-2012 shows \$0.064 EPS growth per year with large excursions that reflect the booms and busts of the semiconductor industry.

In the 2011 Annual Report, I described our World Class Cost program in this way:

“We continuously reduce all corporate expenses with our ‘World Class Cost’ (WCC) program. The idea behind WCC is to get a large number of people actively working in parallel to simultaneously reduce the costs on hundreds of line items. In our detailed 2012 WCC plan, we have 172 employee project ‘owners’ working on 514 individual cost-reduction projects. These projects are grouped together into ‘trackers,’ which aggregate cost savings in a given area; for example, all projects that save energy cost in our San Jose headquarters. Overall, there are 95 trackers run by 54 managers. The trackers are subsequently rolled up into six divisional WCC plans, one for each of our four divisions, one for manufacturing and one for opex. A finance person is assigned to audit each tracker. A senior executive runs the WCC program as his only responsibility.

“For 2012, we have identified \$25.2 million in WCC savings. Eighty percent of the savings are included in the [2012 operating] plan.”

The WCC program actually saved \$45.4 million in 2012, about \$20.2 million more than was required to meet our 2012 operating plan. That extraordinary WCC accomplishment, saving 6.7% of our \$673 million in total expenses in 2012, was aided by extra cost-cutting measures implemented midyear in a down semiconductor environment. The 2013 WCC operating plan is to save \$30.6 million. This objective is also a corporate priority.

The benefit of our WCC program shows up in *Figure 6*, Cypress's 2003-2012 operating expense (opex) trend. The trend line shows a decline in opex of approximately \$5.2 million per year over the last 10 years. We plan to reduce our opex further to \$320 million in 2013—and that target includes the absorption of about \$15 million in annual opex from the Ramtron acquisition. The opex reduction plan, internally called “OPEX80,” is one of our top two corporate priorities for 2013.

### OPERATING EXPENSES

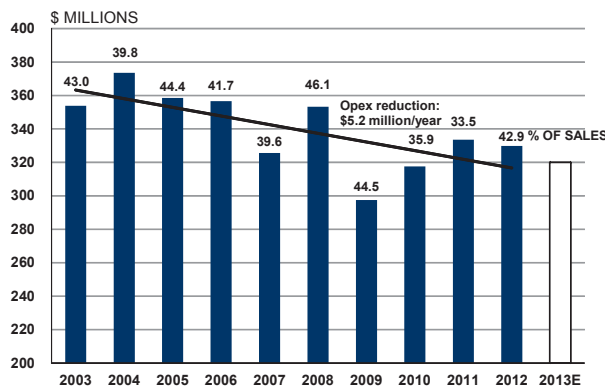

**Figure 6.** Cypress's operating expenses (opex) have varied, but the trend line for 2003-2012 shows that opex has been driven down at the rate of \$5.2 million per year (about 1.5% per year) for a decade. Our 2012 opex of \$330 million was 1.1% lower than in 2011, but it represented 42.9% of sales, well above our target of 30%. This trend should reverse in 2013, when our plan is not only to grow revenue, but also to cut opex to \$320 million. Opex reduction is again one of our top corporate priorities for 2013, meaning that it is one of my formal objectives that is reported quarterly to the Cypress board.

## PSoC

Figure 7 shows our lifetime PSoC unit-shipment trend. With 361 million units shipped in 2012, PSoC matched the million-unit-per-day volume record set in 2011. However, our 2012 PSoC revenue (Figure 8) dropped 27% to \$299 million, obviously due to a mix shift and lower ASPs. Simply put, we shipped more low-end PSoC chips in 2012 than in 2011.

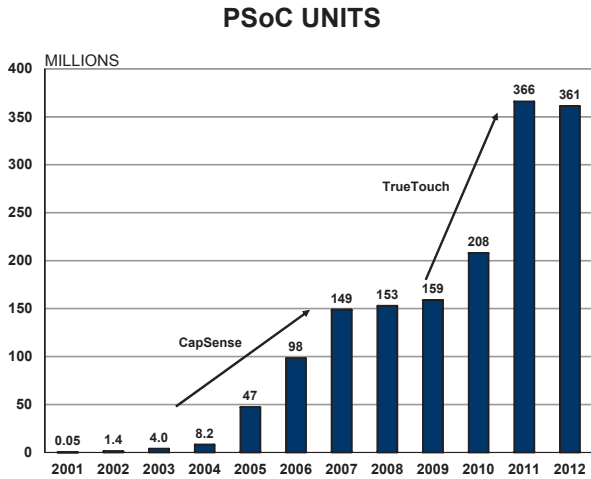

**Figure 7.** The unit shipments of Cypress’s flagship Programmable System-on-Chip (PSoC) products remained at peak levels in 2012—one million units *per day*—despite the soft semiconductor market. We expected to ship another 20-50 million units of our Touch Screen Generation 4 (TSG4) chip during the year, but did not because software problems caused a late market entry.

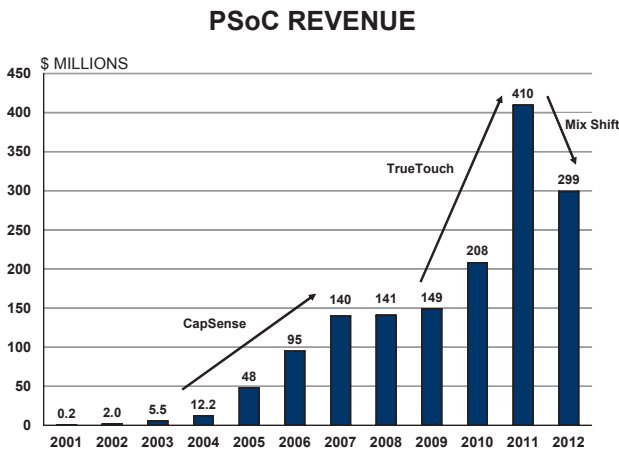

**Figure 8.** The lifetime PSoC revenue trend shows that 2012 PSoC revenue dropped to \$299 million from \$410 million in 2011. This decline was a result of much higher unit sales of smaller, lower-priced PSoC chips, combined with the missed TSG4 touchscreen shipments described in Figure 7. Today, TSG4 is shipping in volume and our TSG5 chip is already in the market with software that was ready when the first TSG5 wafers arrived.

As stated earlier, the \$103 million touchscreen revenue miss is primarily due to a very-late production ramp of our TSG4 TrueTouch chip. The TSG4 chip itself—the hardware—always worked well, as I described in the 2011 Annual Report. Our problem was the software—or, more accurately, the “firmware,” the code used to program TrueTouch chips, which are actually small computers that are more powerful than PCs were until 1992.

For all TrueTouch chips through the TSG3 generation, the firmware was simple enough to be written by our 100-plus Field Application Engineers (FAEs). This capability, to quickly create touchscreen firmware for customers at their sites, gave Cypress a great advantage and contributed to our record \$410 million in 2011 PSoC revenue.

At first, it appeared to us that the firmware for our new TSG4 chip required nothing more than ordinary generational engineering improvements. In fact, the change required was nothing less than a paradigm shift in the way we developed software at Cypress.

Our customers demanded one substantial improvement over the TSG3 touchscreen solution—greater immunity to “charger noise.” Many people work on their cell phones while they are charging them. Unfortunately, most chargers are of the low-cost, “just good enough” variety. They inject noise signals of up to 40 volts into the cell phone at multiple frequencies up to 500,000 cycles per second (think about a radio where the static is 100 times stronger than the music signal). This noise causes missed-touch and false-touch errors that range from just annoying to rendering the cell phone non-functional.

Cell phone user forums are loaded with complaints about this industrywide charger-noise problem. It cannot be fixed with a simple filter. It must be solved at the system level—where, for example, the cell phone is programmed to examine the frequencies of the noise signals coming from the charger (each charger brand is different), and operate the touchscreen at a frequency with minimum noise. Sometimes the noise jumps around in different environments (we once had to deal with a malady known as the “sixth-floor” problem at one of our customers). When the noise changes, the cell phone must change to another, quieter operating frequency while it is being used.

We test our touchscreen solutions by injecting various forms of electronic noise directly into the touchscreen through robotically controlled copper “fingers.” The diameter of these fingers ranges from four millimeters to 22 millimeters (the size of your thumb placed sideways on the screen). The point here is that the charger noise problem became a Ph.D.-level challenge that transcended the capability of our FAEs to create simple firmware programs in the field.

In addition to asking us to fix the charger noise problem, our customers also required that the position of a touch be measured accurately to one millimeter (1/32 of an inch). How do you measure to an accuracy of one millimeter when a typical, 10 millimeter-sized finger is touching a 10-millimeter measurement grid? (Answer: Use sophisticated computer algorithms. See the back cover for the description of a new system, which measures finger placement to 0.001 millimeters.)

Our TrueTouch business unit needed six months to solve the touchscreen problems described above—an eternity in that fast-moving market—and it cost us dearly.

After solving the technical problems, we also permanently improved our software team. We transferred some high-level talent into the TrueTouch group. We acquired a world-class software development group in Istanbul. We consolidated our various software efforts and their 210 engineers under our top software engineer, Alan Hawse, who became a member of Cypress’s Executive Staff. As I said earlier, what started out as an engineering problem ended up requiring a corporate transformation.

This is the third time that a seemingly straightforward engineering problem has forced organizational change at Cypress: In 1993, a nominally simple step to the 0.5-micron node on Moore’s Law shut us down for a year because our process development methods had become obsolete. In 2008, our new, more sophisticated PSoC 3 and PSoC 5 microcontroller designs were delayed by two years because our design methodology had become inadequate.

Our new firmware development process has passed its first test. The TSG5 firmware, including charger noise improvements, was ready when our new TSG5 chip came out in Q4. The chip is already sampling to customers. It is smaller, faster and has twice the

immunity to charger noise of TSG4—but I won’t brag this year; I’ll report accomplishments in the 2013 Annual Report.

Our TrueTouch chips for touchscreens and CapSense® chips for button and slider replacement are special-purpose PSoC chips. In each case, the effort started with a general-purpose PSoC chip that was programmed to perform some new function. We launched our CapSense business in 2005, when Apple used the PSoC code-named Neutron to implement the “clickwheel” on its new iPod. There was a land rush of CapSense business after that. Our CapSense business unit is now No. 1 with over 40% market share.

In 2007, Apple introduced the iPhone, which featured a capacitive touchscreen driven by chips proprietary to Apple. This triggered a land rush for touchscreen chips. We were able to respond to the market quickly by programming a general-purpose PSoC chip, code-named “Radon,” to become a touchscreen chip. We call the theme of these stories “Design Win Replication.” After a hit product surprises the market, Cypress programs a general-purpose PSoC to meet the new market need immediately—and later creates specialized PSoCs, like TrueTouch and CapSense, as the new market matures.

PSoC’s power to rapidly create widely divergent products comes from the integration of microcontrollers, programmable memories, programmable logic gates, programmable analog circuitry, and an overarching system design environment called PSoC Creator™ that allows our customers to co-design hardware and firmware.

Our first PSoC chip—PSoC 1—achieved its first \$2 million of revenue in 2002 (*Figure 7*). At face value, the *Components* of PSoC 1—the chips within a chip—were less powerful than the competing stand-alone chips from other vendors. Renesas and Microchip made more powerful microcontrollers. Linear Technology and Analog Devices made more accurate analog chips. And Xilinx and Altera made bigger programmable logic chips. Nonetheless, PSoC 1—the integrated combination of *Components*—became a market winner that took Cypress’s standing in the 8-bit microcontroller market from No. 35 in 2002 to No. 7 in 2010. During that period, our market share ranking passed that of such notable companies as Sony, Panasonic, Toshiba, Fujitsu and Infineon. PSoC 1 and its CapSense cousins



have become a consistently profitable business with over 600 million units shipped to over 8,000 customers to date.

The second-generation PSoC 3 and PSoC 5 are more powerful than PSoC 1 in every performance measurement, as illustrated in *Figure 9*.

### PSoC 3 AND PSoC 5 vs. PSoC 1

	PSoC 1	PSoC 3	PSoC 5
<b>CENTRAL PROCESSING UNIT</b>			
TYPE	CYPRESS M8	8051	ARM M3
BITS	8	8	32
CLOCK FREQUENCY (MHz)	24	67	80
COMPUTING SPEED (MIPS)*	4	33	100
FLASH MEMORY SIZE (KBYTES)	32	64	256
<b>ANALOG-TO-DIGITAL SAMPLING RATE**</b>			
12 BITS	0.5	192	1,000
20 BITS	-	0.18	0.18
PROGRAMMABLE LOGIC (GATES)	2,000	20,000	20,000
POWER (MILLIWATTS @ 24MHz)	48	12	16

\* Millions of instructions per second  
 \*\* Thousands of samples per second

**Figure 9.** Relative to PSoC 1, the ARM Cortex M3-based PSoC 5 has 25 times more computing power, 8 times more program memory, 2,000 times faster analog-to-digital conversion, and 10 times more programmable logic gates—and still operates on only 16 milliwatts, three times less power than PSoC 1 uses.

These products are now ramping in revenue. We have learned that the bigger PSoC 3 and PSoC 5 chips sell to different customers in totally different segments of the microcontroller market. They offer the PSoC benefit of quick time to new markets using simultaneous hardware and firmware programming. For example, PSoC 3 targets high-reliability automotive touch control interfaces (see the back cover for examples of PSoC in automotive applications). The only disadvantage of PSoC 3 and PSoC 5 is that they are priced two to 10 times higher than our older PSoC 1 chips, which are still producing over \$100 million per year in revenue.

PSoC 4 is Cypress's newest chip. It is a game-changer. It has the performance of PSoC 5 and the cost of PSoC 1. It is being sampled to customers now. Our new design methods produced fully functional chips on the

first wafers. And our new software methods produced working firmware for 12 different demonstration systems only two weeks after the first PSoC 4 samples arrived.

PSoC 4 provides our customers with a sophisticated 32-bit ARM Cortex M0 processor and the superior programmable analog and digital circuitry of PSoC 3 and PSoC 5—all on small chips that will sell for as little as \$1.00. The PSoC 4 story is on both sides of the front cover.

## SRAM

Cypress is the undisputed market leader in SRAMs with 39% share, as shown in *Figure 10*. We have gained SRAM share every year for the last decade.

### CYPRESS SRAM MARKET SHARE

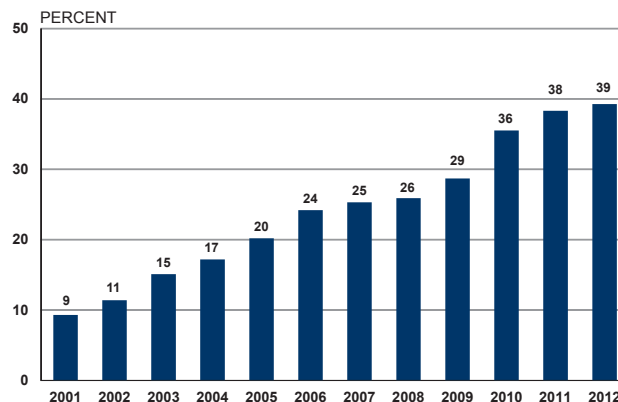
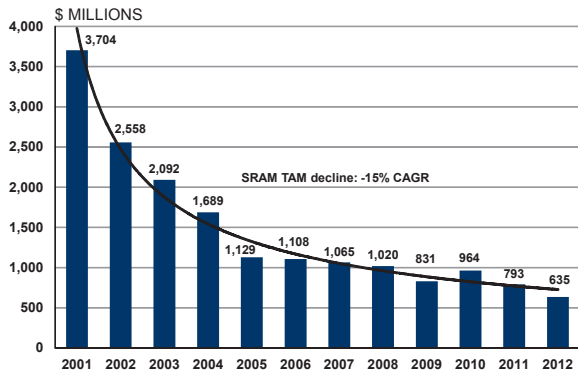

**Figure 10.** Cypress continued to be No. 1 in the SRAM market in 2012 with 39% market share—about 10 percentage points higher than the market share of the No. 2 SRAM supplier, Renesas, which runs the combined SRAM businesses of the former semiconductor divisions of Hitachi, Mitsubishi and NEC.

Our market share is about 10 percentage points higher than the market share of the No. 2 SRAM supplier, Renesas, which runs the combined SRAM businesses of the former semiconductor divisions of Hitachi, Mitsubishi and NEC.

The problem with the SRAM market is that SRAMs, even large ones, can now be integrated into system-level chips such as microprocessors and cell phone application processors, reducing the demand for stand-alone SRAM chips. This has caused a dramatic 15% CAGR decline in the SRAM market over the 2001-2012 period, as shown in *Figure 11*.

### SRAM MARKET



**Figure 11.** The SRAM Total Available Market (TAM) has declined with a -15% CAGR over the 2001-2012 period, due to SRAM integration into system chips, such as microprocessors and cell-phone applications processors. We believe the SRAM TAM will bottom out in the next 2-3 years, when the SRAMs that cannot be made with common foundry technologies will create a smaller but stable market for stand-alone SRAM chips.

Fortunately, the declining SRAM TAM has been largely offset by Cypress’s increasing SRAM market share. The result is that Cypress’s SRAM revenue over the last decade has declined slightly (*Figure 12*) at a rate of \$3.2 million per year. The gradual SRAM revenue decline has in turn been offset by PSoC revenue growth, leaving Cypress’s overall revenue flat during the 2001-2012 period.

### CYPRESS SRAM REVENUE

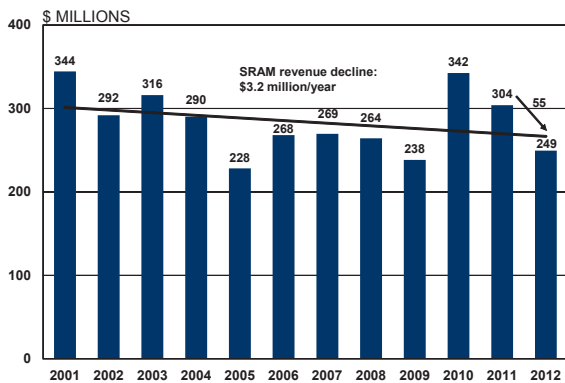

**Figure 12.** Cypress’s SRAM revenue declined sharply from \$304 million in 2011 to \$249 million in 2012 due to a steep drop in the SRAM TAM that was due, in turn, to a semiconductor market downturn combined with the SRAM integration problem described in Figure 11. Cypress’s SRAM revenue has trended downward at a rate of \$3.2 million per year during the 2001-2012 period.

We believe the SRAM TAM will bottom out over the next two to three years, when specialized SRAMs that cannot be made with generic foundry technologies create a stable market for stand-alone SRAMs. These special SRAM families include: (1) very fast synchronous SRAMs (that now require neutron radiation immunity) for data routers and switches, (2) ultra-low power SRAMs for battery-powered products, (3) high-reliability SRAMs for the automotive market, and (4) gamma radiation-tolerant SRAMs for space and military applications. Cypress has business units to address each of these markets.

### NONVOLATILE RAM (NVRAM)

Our Memory Products Division (MPD) also has three NVRAM business units to grow its non-SRAM revenue.

By definition, Random Access Memories (RAMs) allow *fast* access to any stored data in *random* order; they are the workhorse memories that are closely coupled to the processors of most systems, from PCs to routers. Static RAMs, or SRAMs, hold their data as long as the power is on (vs. Dynamic RAMs, or DRAMs, which must be continuously refreshed to hold data, even while the power is on). This DRAM annoyance is tolerated only because DRAMs are 400x cheaper than SRAMs.

NVRAMs create a third RAM category that has all of the functionality of SRAMs and DRAMs with one critical added feature—they retain data when the power goes off. NVRAMs sell for about 15x the price of comparably sized SRAMs. The current DRAM-SRAM-NVRAM average prices per megabit are about \$0.001-\$0.43-\$6.19, respectively. The NVRAM market is thus a high-priced memory niche. Cypress’s NVSRAM revenue will grow to about \$75 million in 2013 with further planned growth to \$100 million in 2015.

Cypress has become one of the worldwide leaders in NVRAMs by investing in three NVRAM technologies, each optimized for a different market need (high speed, high density and low power), as described on the inside back cover. Our 2012 acquisition, Ramtron, makes the lowest-power NVRAMs in the world.

## SHAREHOLDER VALUE

Cypress has delivered a compound annual share price growth rate of 10.7% per year since its IPO in 1986, as shown in our lifetime share price history in *Figure 13*.

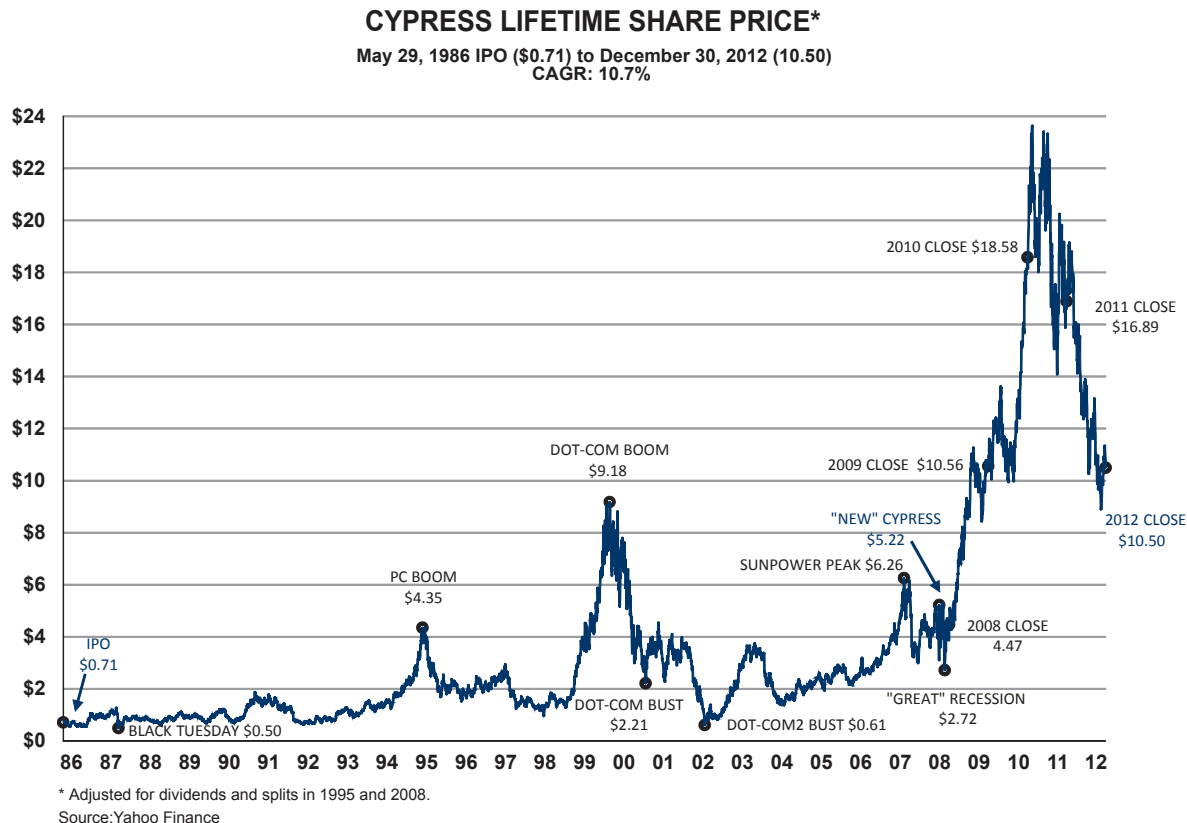

**Figure 13.** Cypress Semiconductor became a public company on May 29, 1986 at a share price of \$0.71, adjusted for splits and the SunPower spinout. Our share price at the end of 2012 was \$10.50, giving us a lifetime share-price CAGR of 10.7% per year. The major events that drove the peaks and valleys over our 26.6 years as a public company are given as annotations. The “New” Cypress label on the September 30, 2008 share price gives the \$5.22 closing price of Cypress stock on the day of the SunPower spinout. This was our initial share price after again becoming a pure-play semiconductor company.

While I am proud of that accomplishment, I am very unhappy with our recent share price performance. (I am Cypress’s second largest shareholder, after Fidelity.) As shown in *Figure 14*, Cypress’s share price dropped 37.8% in 2012, while the benchmark SOX index rose 3.4%. The share price problem was caused by our 2012 revenue decline of \$225 million, whose root causes and corrective actions have been the main topic of this report.

### CYPRESS 2012 RELATIVE SHARE PRICE



**Figure 14.** Cypress’s share price dropped 37.8% in 2012. This was directly attributable to Cypress’s declines in revenue and EPS. The SOX semiconductor index appreciated 3.4% in 2012.

Finally, despite our 2012 problems, our performance since the SunPower spinout (*Figure 15*) has been excellent with 101% appreciation, or a 17.9% CAGR, vs. the performance of the SOX with 22.8% appreciation, or a 5.0% CAGR.

### CYPRESS RELATIVE SHARE PRICE SINCE SPWR SPOFF



**Figure 15.** Cypress’s share price has increased 101% since the SunPower spinout to shareholders at the end of Q3 2008. Cypress’s revenue of \$600 million in Q3 2008 dropped dramatically to \$165 million in semiconductor-only revenue in Q4 2008. After the spinout, Cypress’s share price was reset at \$5.22 (*Figure 13*). Over its 4¼-year lifetime, “New” Cypress has generated a 17.9% CAGR. During the same period, the SOX generated a 5.0% CAGR.

We have also prioritized the return of capital to shareholders since the SunPower spinout, as outlined in *Figure 16*. Our fab-lite model creates positive cash flow, part of which is returned to shareholders as a dividend. We have also repurchased \$1.2 billion in shares, reducing our fully diluted share count to 165 million in 2012, the lowest in a decade.

### CAPITAL RETURN TO SHAREHOLDERS

YEAR	SHARES BOUGHT (MILLIONS)	COST/ SHARE	COST (MILLIONS)	DIVIDEND (MILLIONS)
2012	18.0	\$12.88	\$232	\$63 <sup>1</sup>
2011	36.0	\$18.08	\$651	\$29 <sup>2</sup>
2010	12.6	\$12.29	\$155	N/A
2009	7.7	\$8.03	\$62	N/A
2008 (POST-SPWR)	25.1	\$4.17	\$105	\$2,554 <sup>3</sup>
TOTAL	99.4	\$12.11	\$1,204	\$2,646

<sup>1</sup> Cash dividend at \$0.42 per share

<sup>2</sup> Cash dividend at \$0.36 per share (partial year)

<sup>3</sup> SPWR stock dividend

**Figure 16.** Cypress has prioritized returning capital to shareholders via share repurchases and dividends. Since the \$2.55 billion SunPower spinout, Cypress has repurchased 99.4 million shares for \$1.20 billion dollars and started paying cash dividends in 2011 that now amount to a cumulative \$92.2 million. The total return of capital to shareholders has been \$3.85 billion over the 4¼-year life of the “New” Cypress.

### CONCLUSION

In 1992, Cypress suffered its first-ever revenue decline and loss. We had grown rapidly and lost our startup intensity. Some employees wondered if we would be another “Silicon Valley miracle” that went public and then got acquired.

On one return flight from Japan, I worked my way down to the very last item in the “emergency” reading material I always keep on the bottom of my briefcase. It was a paper, “Organizational Vision and Visionary Organizations,” sent to me unsolicited by Prof. Jim Collins of the Stanford Business School—well before Collins and his co-author, Prof. Jerry Porras, wrote the blockbuster hit, “Built to Last,” in 1994.

Although Cypress had a very strong culture, I learned how important reinforcing culture was by reading what I still consider to be the most important business paper I've ever read. I hired Collins and Porras as consultants, and I spent the next six months talking to small groups of employees in an effort to formally codify what common beliefs Cypress people held; that is, our Core Values.

After refinement and wordsmithing, our statement of Core Values now hangs framed on each floor of every Cypress building. Our employees know that almost all Cypress EVPs are long-tenured engineers who truly believe in our Core Values and have worked their way to the top.

Our Core Values are embraced by Cypress employees. For example, Cypress's Core Value No. 2 reads:

"We are smart, tough and work hard. We tell the truth and don't make excuses. We value

knowledge, logic and reason. We admit to and solve problems quickly. We deplore politicians." (This refers to corporate politicians.)

The first sentence in Cypress's Core Value No. 1, written in 1994, reads as follows:

"We do not tolerate losing."

That's how the Executive Staff and I feel about 2012.

By year-end 2013, the word "losing" will be erased from our investors' vocabulary.



T.J. Rodgers  
President and CEO

This is the 27th Annual Report I've written for our public shareholders. I thank the Cypress employees who helped to create the report, often after-hours and over the weekends. We tell our own story without the use of ad agencies or PR firms. *TJR*

All financial comments relate to our non-GAAP financial reporting unless otherwise noted.

The preceding letter contains several forward-looking statements made subject to the safe harbor provisions of the Private Litigation Reform Act of 1995, regarding, among other things, our financial performance in the current economy, our expected revenue and growth of our Emerging Technology Division (ETD), the accretive nature of our Ramtron acquisition, our expected savings from our World Class Cost (WCC) program, our plans to further reduce our operating expenses in 2013, our expectations regarding our latest touchscreen chip, TSG5, and our expectations regarding the bottoming out of the SRAM TAM. Readers are cautioned that these forward-looking statements are not guarantees and may differ materially from actual future events or results due to a variety of factors, including but not limited to: the possibility of a further decline in the general economy, the economic conditions and growth trends in the semiconductor industry and the markets served by Cypress and its Emerging Technology Division (ETD), whether or not our ETD startups operate profitably and gain market acceptance of their product offerings, whether the expected success of TSG5 is achieved, our ability to successfully integrate Ramtron and achieve our expected revenue gains, market acceptance of new product offerings, industry wide shifts in supply and demand, our ability to continue to drive down our operating expenses and meet our WCC program goals and other risks identified in Cypress's most recent reports on Form 10-K and 10-Q, including in this Annual Report. We use words such as "anticipates," "believes," "expects," "forecast," "future," "intends," "look forward," "plans," "should," and similar expressions to identify such forward-looking statements. All forward-looking statements included in the preceding letter are based upon information available to, and the expectations of, Cypress management as of the date of the letter, which may change. We assume no obligation to update any such forward-looking statement. Such information speaks only as of the date of this release.

## CONTENTS

To supplement its consolidated financial results presented in accordance with GAAP, Cypress uses non-GAAP financial measures which are adjusted from the most directly comparable GAAP financial measures to exclude certain items, as described in the following reconciliation tables. Management believes that these non-GAAP financial measures reflect an additional and useful way of viewing aspects of Cypress's operations that, when viewed in conjunction with Cypress's GAAP results, provide a more comprehensive understanding of the various factors and trends affecting Cypress's business and operations.

Cypress uses each of these non-GAAP financial measures for internal managerial purposes, when providing its financial results and business outlook to the public, and to facilitate period-to-period comparisons. Management believes that these non-GAAP measures provide meaningful supplemental information regarding Cypress's operational and financial performance of current and historical results. Management uses these non-GAAP measures for strategic and business decision making, internal budgeting, forecasting and resource allocation processes. In addition, these non-GAAP financial measures facilitate management's internal comparisons to Cypress's historical operating results and comparisons to competitors' operating results.

Cypress believes that providing these non-GAAP financial measures, in addition to the GAAP financial results, are useful to investors because they allow investors to see Cypress's results "through the eyes" of management as these non-GAAP financial measures reflect Cypress's internal measurement processes. Management believes that these non-GAAP financial measures enable investors to better assess changes in each key element of Cypress's operating results across different reporting periods on a consistent basis. Thus, management believes that each of these non-GAAP financial measures provides investors with another method for assessing Cypress's operating results in a manner that is focused on the performance of its ongoing operations.

<b>Consolidated Statements of Operations (Annual)</b> .....	<b>13</b>
<b>Reconciliation of GAAP to Non-GAAP Financial Measures (Annual)</b> .....	<b>14</b>
<b>Consolidated Statements of Operations (Quarterly)</b> .....	<b>15</b>
<b>Reconciliation of GAAP to Non-GAAP Financial Measures (Quarterly)</b> .....	<b>16</b>
<b>GAAP and Non-GAAP Financial Measures as a Percentage of GAAP and Non-GAAP Revenue (Quarterly)</b> .....	<b>16</b>
<b>Consolidated Balance Sheets</b> .....	<b>17</b>

## Consolidated Statements of Operations (Annual)

(In millions, except per-share data)

	Year Ended		
	Dec. 30, 2012	Jan. 1, 2012	Jan. 2, 2011
Revenues	\$ 770	\$ 995	\$ 878
Costs and expenses (credits):			
Cost of revenues	377	448	388
Research and development	190	190	177
Selling, general and administrative	212	228	219
Amortization of acquisition-related intangible assets	4	3	3
Restructuring costs	4	6	3
(Gain) loss on divestiture	2	(34)	-
Total costs and expenses, net	789	841	790
Operating income (loss)	(19)	154	88
Interest and other income (expense), net	(3)	2	6
Income (loss) before income taxes and noncontrolling interest	(22)	156	94
Income tax provision (benefit)	2	(11)	19
Income (loss), net of taxes	(24)	167	75
Loss attributable to noncontrolling interest, net of income taxes	2	1	1
Net income (loss) attributable to Cypress	\$ (22)	\$ 168	\$ 76
Net income (loss) per share attributable to Cypress:			
Basic	\$ (0.15)	\$ 1.02	\$ 0.47
Diluted	\$ (0.15)	\$ 0.90	\$ 0.40
Cash dividend declared per share	\$ 0.44	\$ 0.27	\$ -
Weighted-average shares outstanding:			
Basic	149	164	161
Diluted	149	187	191

## Reconciliation of GAAP to Non-GAAP Financial Measures (Annual)

(In millions, except per-share data)

	Year Ended		
	Dec. 30, 2012	Jan. 1, 2012	Jan. 2, 2011
GAAP revenues	\$ 770	\$ 995	\$ 878
SRAM legal settlement	-	-	6
Non-GAAP revenues	\$ 770	\$ 995	\$ 884
GAAP gross margin	\$ 393	\$ 546	\$ 489
Stock-based compensation expense	19	24	23
Impairment of assets and others	4	-	-
Patent license fee	7	-	-
Acquisition-related expense	3	-	-
Divestiture expenses	1	-	-
SRAM legal settlement	-	-	6
Non-GAAP gross margin	\$ 427	\$ 570	\$ 518
GAAP research and development expenses	\$ 190	\$ 190	\$ 177
Stock-based compensation expense	(20)	(24)	(22)
Acquisition-related expense	(3)	-	-
Changes in value of deferred compensation plan (1)	(1)	-	-
Non-GAAP research and development expenses	\$ 166	\$ 166	\$ 155
GAAP selling, general and administrative expenses	\$ 212	\$ 228	\$ 219
Stock-based compensation expense	(36)	(53)	(47)
Impairment of assets and other	-	(4)	(5)
Acquisition-related expense	(9)	-	-
Divestiture expenses	(1)	-	-
Changes in value of deferred compensation plan (1)	(2)	1	(2)
Building donation	-	(4)	-
SRAM legal settlement	-	-	(1)
Non-GAAP selling, general and administrative expenses	\$ 164	\$ 168	\$ 164
GAAP operating income (loss)	\$ (19)	\$ 154	\$ 88
Stock-based compensation expense	74	101	92
Impairment of assets and other	4	4	5
Patent license fee	7	-	-
Acquisition-related expenses	20	3	3
(Gain) loss on divestiture and expenses	3	(34)	-
Changes in value of deferred compensation plan (1)	3	(1)	3
Non-cash compensation	1	-	-
Restructuring costs	4	6	3
Building donation	-	4	-
SRAM legal settlement	-	-	7
Non-GAAP operating income	\$ 97	\$ 237	\$ 201
GAAP net income (loss) attributable to Cypress	\$ (22)	\$ 168	\$ 76
Stock-based compensation expense	74	101	92
Impairment of assets and other	4	4	5
Patent license fee	7	-	-
Acquisition-related expenses	20	3	3
(Gain) loss on divestiture and expenses	3	(34)	-
Changes in value of deferred compensation plan (1)	(1)	-	-
Non-cash compensation	1	-	-
Restructuring costs	4	6	3
Building donation	-	4	-
SRAM legal settlement	-	-	7
Investment-related losses (gains)	3	-	(3)
Tax effects	(2)	(14)	3
Non-GAAP net income attributable to Cypress	\$ 91	\$ 238	\$ 186
GAAP net income (loss) per share attributable to Cypress - diluted	\$ (0.15)	\$ 0.90	\$ 0.40
Stock-based compensation expense	0.45	0.53	0.45
Impairment of assets and other	0.02	0.02	0.03
Patent license fee	0.04	-	-
Acquisition-related expenses	0.12	0.02	0.01
Gain (loss) on divestiture and expenses	0.02	(0.18)	-
Restructuring costs	0.03	0.04	0.01
Building donation	-	0.02	-
SRAM legal settlement	-	-	0.04
Investment-related losses (gains)	0.02	-	(0.02)
Tax effects	(0.01)	(0.08)	0.02
Non-GAAP share count adjustment	0.01	(0.02)	-
Non-GAAP net income per share attributable to Cypress - diluted	\$ 0.55	\$ 1.25	\$ 0.94

(1) Consistent with the current presentation, all prior periods have been recast to reflect changes in deferred compensation plan



## Consolidated Statements of Operations (Quarterly)

(In millions, except per-share data)

	Quarter Ended							
	Dec. 30, 2012	Sep. 30, 2012	Jul. 1, 2012	Apr. 1, 2012	Jan. 1, 2012	Oct. 2, 2011	Jul. 3, 2011	Apr. 3, 2011
GAAP revenues	\$ 180	\$ 203	\$ 202	\$ 185	\$ 242	\$ 265	\$ 255	\$ 233
Costs and expenses (credits):								
Cost of revenues	96	93	95	93	112	116	116	104
Research and development	47	47	48	48	47	46	49	48
Selling, general and administrative	53	47	52	60	55	55	59	59
Amortization of acquisition-related intangible assets	1	1	1	1	1	1	1	1
Restructuring costs	3	-	1	-	1	1	4	-
(Gain) loss on divestiture	2	-	-	-	-	-	-	(34)
Total costs and expenses, net	202	188	197	202	216	219	229	178
Operating income (loss)	(22)	15	5	(17)	26	46	26	55
Interest and other income (expense), net	(2)	(1)	-	-	3	(2)	-	2
Income (loss) before income taxes and noncontrolling interest	(24)	14	5	(17)	29	44	26	57
Income tax provision (benefit)	-	-	-	2	(2)	4	(15)	2
Income (loss), net of taxes	\$ (24)	\$ 14	\$ 5	\$ (19)	\$ 31	\$ 40	\$ 41	\$ 55
Loss attributable to noncontrolling interest, net of income taxes	2	-	-	-	1	-	-	-
Net income (loss) attributable to Cypress	\$ (22)	\$ 14	\$ 5	\$ (19)	\$ 32	\$ 40	\$ 41	\$ 55
Net income (loss) per share - basic	\$ (0.15)	\$ 0.10	\$ 0.03	\$ (0.13)	\$ 0.21	\$ 0.24	\$ 0.24	\$ 0.32
Net income (loss) per share - diluted	\$ (0.15)	\$ 0.09	\$ 0.03	\$ (0.13)	\$ 0.18	\$ 0.22	\$ 0.21	\$ 0.28
Cash dividend declared per share	\$ 0.11	\$ 0.11	\$ 0.11	\$ 0.11	\$ 0.09	\$ 0.09	\$ 0.09	\$ -
Weighted-average shares outstanding:								
Basic	144	148	152	154	154	164	169	171
Diluted	144	160	165	154	172	183	192	200

## Reconciliation of GAAP to Non-GAAP Financial Measures (Quarterly)

(In millions)

	Quarter Ended								
	Dec. 30, 2012	Sep. 30, 2012	Jul. 1, 2012	Apr. 1, 2012	Jan. 1, 2012	Oct. 2, 2011	Jul. 3, 2011	Apr. 3, 2011	
GAAP gross margin	\$ 84	\$ 110	\$ 107	\$ 92	\$ 130	\$ 149	\$ 139	\$ 129	
Stock-based compensation expense	2	5	8	4	6	5	7	6	
Impairment of assets and other	2	1	1	-	-	-	-	-	
Patent license fee	-	-	-	7	-	-	-	-	
Acquisition-related expense	3	-	-	-	-	-	-	-	
Divestiture expenses	1	-	-	-	-	-	-	-	
Changes in value of deferred compensation plan (1)	-	-	-	-	-	(1)	-	-	
Non-GAAP gross margin	\$ 92	\$ 116	\$ 116	\$ 103	\$ 136	\$ 153	\$ 146	\$ 135	
GAAP research and development expenses	\$ 47	\$ 47	\$ 48	\$ 48	\$ 47	\$ 46	\$ 49	\$ 48	
Stock-based compensation expense	(2)	(5)	(6)	(7)	(6)	(6)	(7)	(5)	
Acquisition-related expenses	(3)	-	-	-	-	-	-	-	
Changes in value of deferred compensation plan (1)	(1)	-	-	-	-	1	-	(1)	
Non-GAAP research and development	\$ 41	\$ 42	\$ 42	\$ 41	\$ 41	\$ 41	\$ 42	\$ 42	
GAAP selling, general and administrative	\$ 52	\$ 47	\$ 52	\$ 61	\$ 55	\$ 55	\$ 59	\$ 59	
Stock-based compensation expense	(3)	(6)	(9)	(18)	(13)	(14)	(16)	(9)	
Impairment of assets and other	-	-	-	-	-	(2)	(2)	-	
Acquisition-related expenses	(7)	-	(2)	-	-	-	-	-	
Divestiture expenses	(1)	-	-	-	-	-	-	-	
Changes in value of deferred compensation plan (1)	-	(1)	-	(1)	(1)	2	-	(1)	
Building donation	-	-	-	-	-	-	-	(4)	
Non-GAAP selling, general and administrative	\$ 41	\$ 40	\$ 41	\$ 42	\$ 41	\$ 41	\$ 41	\$ 45	
GAAP operating income (loss)	\$ (21)	\$ 15	\$ 5	\$ (18)	\$ 26	\$ 46	\$ 26	\$ 55	
Stock-based compensation expense	7	16	22	29	25	25	30	21	
Impairment of assets and other	3	1	-	-	-	2	2	-	
Patent license fee	-	-	-	7	-	-	-	-	
Acquisition related expenses	15	1	3	1	1	1	1	1	
(Gain) loss on divestiture and expenses	3	-	-	-	-	-	-	(34)	
Changes in value of deferred compensation plan (1)	(1)	2	-	2	2	(4)	-	1	
Non-cash compensation	1	-	-	-	-	-	-	-	
Restructuring costs	3	-	1	-	1	-	4	1	
Building donation	-	-	-	-	-	-	-	4	
Non-GAAP operating income	\$ 10	\$ 35	\$ 31	\$ 21	\$ 55	\$ 70	\$ 63	\$ 49	
GAAP net income (loss) attributable to Cypress	\$ (22)	\$ 14	\$ 5	\$ (19)	\$ 32	\$ 40	\$ 41	\$ 55	
Stock-based compensation expense	7	16	22	29	25	25	30	21	
Impairment of assets and other	1	1	-	2	-	2	2	-	
Patent license fee	-	-	-	7	-	-	-	-	
Acquisition related expenses	15	1	3	1	1	1	1	1	
(Gain) loss on divestiture and expenses	3	-	-	-	-	-	-	(34)	
Changes in value of deferred compensation plan (1)	(1)	-	-	-	-	-	-	-	
Non-cash compensation	1	-	-	-	-	-	-	-	
Restructuring costs	3	-	1	-	1	-	4	1	
Building donation	-	-	-	-	-	-	-	4	
Investment-related gains/losses	2	2	(1)	-	-	(1)	-	-	
Tax/other expense effects on non-GAAP adjustments	(1)	(2)	-	1	(2)	2	(14)	1	
Non-GAAP net income attributable to Cypress	\$ 8	\$ 32	\$ 30	\$ 21	\$ 57	\$ 69	\$ 63	\$ 49	

(1) Consistent with the current presentation, all prior periods have been recast to reflect changes in deferred compensation plan as a Non-GAAP adjustment.

## GAAP and Non-GAAP Financial Measures as a Percentage of GAAP and Non-GAAP Revenue (Quarterly)

	Quarter Ended								
	Dec. 30, 2012	Sep. 30, 2012	Jul. 1, 2012	Apr. 1, 2012	Jan. 1, 2012	Oct. 2, 2011	Jul. 3, 2011	Apr. 3, 2011	
GAAP gross margin	47%	54%	53%	50%	54%	56%	55%	55%	
Non-GAAP gross margin	51%	57%	57%	56%	56%	58%	57%	58%	
GAAP research and development expenses	26%	23%	24%	26%	19%	17%	19%	21%	
Non-GAAP research and development	23%	21%	21%	22%	17%	15%	16%	18%	
GAAP selling, general and administrative	29%	23%	26%	33%	23%	21%	23%	25%	
Non-GAAP selling, general and administrative	23%	20%	20%	23%	17%	15%	16%	19%	
GAAP operating income (loss)	-12%	7%	2%	-10%	11%	17%	10%	24%	
Non-GAAP operating income	6%	17%	15%	11%	23%	26%	25%	21%	
GAAP net income (loss) attributable to Cypress	-12%	7%	2%	-10%	13%	15%	16%	24%	
Non-GAAP net income attributable to Cypress	4%	16%	15%	11%	24%	26%	25%	21%	

## Consolidated Balance Sheets

(In millions)

	As of	
	Dec. 30, 2012	Jan. 1, 2012
<b>ASSETS</b>		
Cash, cash equivalents and short-term investments	\$ 117	\$ 166
Accounts receivable, net	83	104
Inventories	128	92
Property, plant and equipment, net	275	285
Goodwill and other intangible assets	113	41
Other assets [1]	116	122
<b>Total assets</b>	<b>\$ 832</b>	<b>\$ 810</b>
<b>LIABILITIES AND STOCKHOLDERS' EQUITY</b>		
Accounts payable	\$ 59	\$ 53
Deferred income	131	151
Income tax liabilities	48	43
Long-term revolving credit facility	232	-
Other liabilities	185	165
<b>Total liabilities</b>	<b>655</b>	<b>412</b>
Total Cypress stockholders' equity	181	400
Non-controlling interest	(4)	(2)
<b>Total equity [2]</b>	<b>177</b>	<b>398</b>
<b>Total liabilities and stockholders' equity</b>	<b>\$ 832</b>	<b>\$ 810</b>

[1] Includes auction rate securities of \$6 and \$21 classified as long term investments as of December 30, 2012 and January 1, 2012, respectively.

[2] Common stock: 650 and 650 shares authorized; 287 and 279 shares issued; 144 and 154 shares outstanding as of December 30, 2012 and January 1, 2012, respectively.

## CORPORATE INFORMATION

<b>BOARD OF DIRECTORS</b>	W. Steve Albrecht <sup>(1)</sup>	Andersen Alumni Professor of Accounting, Marriott School of Management, Brigham Young University
	Eric A. Benhamou <sup>(1,2)</sup>	Chairman of our Board, Former Chairman of the Board of 3Com
	Lloyd Carney <sup>(2)</sup>	CEO Brocade Communications Systems
	James R. Long <sup>(2,3)</sup>	Former Executive Vice President of Nortel Networks
	J. Daniel McCranie <sup>(1,3,4)</sup>	Chairman of the Board of ON Semiconductor
	T. J. Rodgers	President and Chief Executive Officer of Cypress
	J.D. Sherman <sup>(1)</sup>	President and COO, HubSpot
	Wilbert van den Hoek <sup>(3,4)</sup>	Former Executive Vice President and CTO, Novellus Systems, Inc.
<b>EXECUTIVE MANAGEMENT</b>	T. J. Rodgers	Founder, President, Chief Executive Officer and Director
	Brad W. Buss	Executive Vice President, Finance and Administration and Chief Financial Officer
	Sabbas Daniel	Executive Vice President, Quality
	J. Augusto de Oliveria	Executive Vice President and Chief Technical Officer
	Hassane El-Khoury	Executive Vice President, Programmable Systems Division
	Alan Hawse	Executive Vice President, Software Development
	Paul Keswick	Executive Vice President, New Product Development, Engineering, IT
	Badri Kothandaraman	Executive Vice President, Data Communications Division and Executive Director of Cypress Semiconductor Technology India Private Limited
	Dana Nazarian	Executive Vice President, Memory Products Division
	Minh Phan	Executive Vice President, Worldwide Manufacturing and Operations
	Christopher Seams	Executive Vice President, Sales and Marketing
	Thomas Surrette	Executive Vice President, Human Resources
	Timothy L. Olson	President & CEO, Deca Technologies, Inc. (subsidiary)
	Ron Sartore	CEO, AgigA Tech, Inc. (subsidiary)
<b>LEGAL MATTERS</b>	Questions regarding legal matters should be directed to:	
	Victoria Valenzuela	General Counsel and Vice President, Legal
<b>LEGAL COUNSEL</b>	Wilson Sonsini Goodrich & Rosati, P.C.	
	650 Page Mill Road Palo Alto, California 94304-1050 (650) 493-9300	
<b>INDEPENDENT ACCOUNTANTS</b>	PricewaterhouseCoopers LLP	
	488 Almaden Blvd., Suite 1800 San Jose, California 95110 (408) 817-3700	
<b>CORPORATE HEADQUARTERS</b>	Cypress Semiconductor Corporation	Telephone: (408) 943-2600
	198 Champion Court San Jose, California 95134-1709	Facsimile: (408) 943-4730 Internet: <a href="http://www.cypress.com">http://www.cypress.com</a>
<b>REGISTRAR AND TRANSFER AGENT</b>	Computershare Trust Company, NA	
	PO Box 43078 Providence, RI 02940-3078 (781) 575-2879	

### ANNUAL MEETING

The annual meeting of stockholders for Cypress Semiconductor Corporation will be held on Friday, May 10, 2013, 10:00 a.m., Pacific Daylight Time, at Cypress's offices at 198 Champion Court, San Jose, California 95134-1709.

### COMMON STOCK

Cypress Semiconductor Corporation's common stock is traded on the NASDAQ Global Select Market under the symbol "CY."

### FORM 10-K

A copy of Cypress's Annual Report on Form 10-K, as filed with the Securities and Exchange Commission on February 28, 2013, will be made available without charge to all stockholders upon written request to Cypress. Direct requests may be made to the Attention of the Chief Financial Officer at 198 Champion Court, San Jose, Calif. 95134-1709.

<sup>(1)</sup> Member of the Audit Committee

<sup>(2)</sup> Member of the Compensation Committee

<sup>(3)</sup> Member of the Nominating and Governance Committee

<sup>(4)</sup> Member of the Operations Committee

The letter to Stockholders and "Management Discussion and Analysis" contain a number of forward-looking statements about the prospects for Cypress and its subsidiaries as well as the semiconductor industry more generally, which are based on our current information and expectations and could be affected by uncertainties and risk factors, including but not limited to those described in our Annual Report on Form 10-K, filed February 28, 2013. Our actual results may differ materially. We use words such as, "anticipates", "believes", "expects", "future", "planning", "intends" and similar expressions to identify forward-looking statements which include statements related to our prices, growth, supply, operations, shipments, our current and future products, profit and revenue.

Cypress, the Cypress logo, PSoC, CapSense, EZ-USB and TrueTouch are registered trademarks of Cypress Semiconductor Corp. PSoC Components, PSoC Creator, and FX3 are trademarks of Cypress Semiconductor Corp. SunPower is a registered trademark of SunPower Corp. AgigA and AGIGARAM are registered trademarks of AgigA Tech. Inc. Cypress Envirosystems is a trademark of Cypress Systems Corporation. ARM is a registered trademark and Cortex and ARM9 are trademarks of ARM Limited. Leap Motion is a trademark of Leap Motion, Inc. Tesla is a trademark of Tesla Motors, Inc. Toyota is a trademark of Toyota Motor Corporation. DENSO is a trademark of DENSO Corporation. Kindle is a trademark of Amazon.com, Inc. Samsung, Samsung EZON and Samsung Galaxy Grand DUOS are registered trademarks of Samsung Electronics Co. Ltd. Corp. Saeco is a trademark of Koninklijke Philips Electronics.N.V. Apple, iPhone and iPod are trademarks of Apple Inc. All other trademarks are the properties of their respective owners.

---

---

**UNITED STATES  
SECURITIES AND EXCHANGE COMMISSION**  
Washington, D.C. 20549

---

**Form 10-K**

---

(Mark One)

**ANNUAL REPORT PURSUANT TO SECTION 13 OR 15(d) OF THE SECURITIES EXCHANGE ACT OF 1934**

For the fiscal year ended December 30, 2012

Or

**TRANSITION REPORT PURSUANT TO SECTION 13 OR 15(d) OF THE SECURITIES EXCHANGE ACT OF 1934**

For the transition period from \_\_\_\_\_ to \_\_\_\_\_

Commission file number: 1-10079

---

**CYPRESS SEMICONDUCTOR CORPORATION**

(Exact name of registrant as specified in its charter)

---

**Delaware**  
(State or other jurisdiction of  
incorporation or organization)

**94-2885898**  
(I.R.S. Employer  
Identification No.)

**198 Champion Court, San Jose, California 95134**

(Address of principal executive offices and zip code)

**Registrant's telephone number, including area code: (408) 943-2600**

---

**Securities registered pursuant to Section 12(b) of the Act:**

Title of Each Class

Name of Each Exchange on Which Registered

---

Common Stock, \$.01 par value

The NASDAQ Stock Market

**Securities registered pursuant to Section 12(g) of the Act:**

None

---

Indicate by check mark if the registrant is a well-known seasoned issuer, as defined in Rule 405 of the Securities Act.  Yes  No

Indicate by check mark if the registrant is not required to file reports pursuant to Section 13 or Section 15(d) of the Act.  Yes  No

Indicate by check mark whether the registrant (1) has filed all reports required to be filed by Section 13 or 15(d) of the Securities Exchange Act of 1934 during the preceding 12 months (or for such shorter period that the registrant was required to file such reports), and (2) has been subject to such filing requirements for the past 90 days.  Yes  No

Indicate by check mark whether the registrant has submitted electronically and posted on its corporate Website, if any, every Interactive Data File required to be submitted and posted pursuant to Rule 405 of Regulation S-T during the preceding 12 months (or for such shorter period that the registrant was required to submit and post such files).  Yes  No

Indicate by check mark if disclosure of delinquent filers pursuant to Item 405 of Regulation S-K is not contained herein, and will not be contained, to the best of registrant's knowledge, in definitive proxy or information statements incorporated by reference in Part III of this Form 10-K or any amendment to this Form 10-K.

Indicate by check mark whether the registrant is a large accelerated filer, an accelerated filer, a non-accelerated filer, or a smaller reporting company. See the definitions of "larger accelerated filer," "accelerated filer," and "smaller reporting company" in Rule 12b-2 of the Exchange Act. (Check one):

Large accelerated filer  Accelerated filer  Non-accelerated filer  Smaller reporting company

Indicate by check mark whether the registrant is a shell company (as defined in Rule 12b-2 of the Act).  Yes  No

The market value of voting and non-voting common stock held by non-affiliates of the registrant, based upon the closing sale price of the common stock on July 1, 2012 as reported on the NASDAQ Global Select Market, was approximately \$1.8 billion. Shares of common stock held by each executive officer and director and by each person who owns 5% or more of the outstanding common stock have been excluded from the foregoing calculation in that such persons may be deemed affiliates. This determination of affiliate status is not necessarily a conclusive determination for other purposes.

As of February 15, 2013, 145,984,047 shares of the registrant's common stock were outstanding.

**DOCUMENTS INCORPORATED BY REFERENCE**

Portions of the Definitive Proxy Statement for the registrant's Annual Meeting of Stockholders to be filed pursuant to Regulation 14A for the year ended December 30, 2012 are incorporated by reference in Items 10 - 14 of Part III of this Annual Report on Form 10-K.

---

---

## TABLE OF CONTENTS

	<u>Page</u>
<b>PART I</b>	
Item 1 Business	4
Item 1A Risk Factors	18
Item 1B Unresolved Staff Comments	29
Item 2 Properties	29
Item 3 Legal Proceedings	30
Item 4 Mine Safety Disclosures	30
<b>PART II</b>	
Item 5 Market for Registrant’s Common Equity, Related Stockholder Matters and Issuer Purchases of Equity Securities	31
Item 6 Selected Financial Data	36
Item 7 Management’s Discussion and Analysis of Financial Condition and Results of Operations	37
Item 7A Quantitative and Qualitative Disclosure About Market Risk	56
Item 8 Financial Statements and Supplementary Data	57
Item 9 Changes in and Disagreements with Accountants on Accounting and Financial Disclosures	110
Item 9A Controls and Procedures	110
Item 9B Other Information	111
<b>PART III</b>	
Item 10 Directors, Executive Officers and Corporate Governance	112
Item 11 Executive Compensation	112
Item 12 Security Ownership of Certain Beneficial Owners and Management and Related Stockholder Matters	113
Item 13 Certain Relationships and Related Transactions and Director Independence	113
Item 14 Principal Accountant Fees and Services	113
<b>PART IV</b>	
Item 15 Exhibits and Financial Statement Schedule	114
Signatures and Power of Attorney	118

## STATEMENTS

The discussion in this Annual Report on Form 10-K contains statements that are not historical in nature, but are forward-looking statements within the meaning of Section 27A of the Securities Act of 1933, as amended, and Section 21E of the Securities Exchange Act of 1934, as amended, that involve risks and uncertainties, including, but not limited to, statements related to our manufacturing strategy, the expected timing and costs related to our acquisition of Ramtron International Corporation, our expectation regarding dividends and stock repurchases, our expectations regarding future technology transfers and other licensing arrangements, our expectations regarding the timing and cost of our restructuring liabilities, expected purchases by IV, our expectations regarding our active litigation matters, our intention to appeal the GSI ruling and our intent to defend ourselves in those matters; the competitive advantage we believe we have with our patents as well as our proprietary programmable technologies and programmable products, our backlog as an indicator of future performance, the risk associated with our yield investment agreements, our foreign currency exposure and the impact exchange rates could have on our operating margins, the adequacy of our cash and working capital positions, the value and liquidity of our investments, including auction rate securities and our other debt investments, our ability to recognize certain unrecognized tax benefits within the next twelve months as well as the resolution of agreements with various foreign tax authorities, including especially our recent India tax audit, our investment strategy, the impact of interest rate fluctuations on our investments, the volatility of our stock price, the adequacy of our real estate properties, the utility of our non-GAAP reporting, the adequacy of our audits, the potential impact of our indemnification obligations and the impact of new accounting standards on our financial statements. We use words such as “plan,” “anticipate,” “believe,” “expect,” “future,” “intend” and similar expressions to identify forward-looking statements. Such forward-looking statements are made as of the date hereof and are based on our current expectations, beliefs and intentions regarding future events or our financial performance and the information available to management as of the date hereof. Except as required by law, we assume no responsibility to update any such forward-looking statements. Our actual results could differ materially from those expected, discussed or projected in the forward-looking statements contained in this Annual Report on Form 10-K for any number of reasons, including, but not limited to, the state and future of the general economy and its impact on the markets and consumers we serve and our investments; our ability to timely deliver our proprietary and programmable technologies and products, the current credit conditions; our ability to expand our customer base, our ability to transform our business with a leading portfolio of programmable products; the number and nature of our competitors; the changing environment and/or cycles of the semiconductor industry; foreign currency exchange rates; our ability to efficiently manage our manufacturing facilities and achieve our cost goals emanating from our flexible manufacturing strategy; our ability to achieve our goals related to our restructuring activities; our success in our pending litigation matters, our ability to manage our investments and interest rate and exchange rate exposure; changes in the law, the results of our pending tax examinations; our ability to achieve liquidity in our investments, the failure or success of our Emerging Technology division and/or the materialization of one or more of the risks set forth above or in Item 1A (*Risk Factors*) in this Annual Report on Form 10-K.

## PART I

### ITEM 1.

#### General

Cypress Semiconductor Corporation (“Cypress”) delivers high-performance, mixed-signal, programmable solutions that provide customers with rapid time-to-market and exceptional system value. Our offerings include the flagship Programmable System-on-Chip (“PSoC<sup>®</sup>”) families and derivatives such as CapSense<sup>®</sup> touch sensing and TrueTouch<sup>®</sup> solutions for touchscreens. We are the world leader in Universal Serial Bus (“USB”) controllers, including the high-performance West Bridge<sup>®</sup> solution that enhances connectivity and performance in multimedia handsets. In addition we are the industry leader in the high-performance SRAM memory market and a market leader in programmable timing devices. We serve numerous markets including consumer, mobile handsets, computation, data communications, automotive, industrial and military. Cypress programmable products can be found in a wide array of the world’s leading end products, including cell phones, tablets, PCs and PC peripherals, audio and gaming devices, household appliances, and communications devices.

Cypress was incorporated in California in December 1982. The initial public offering took place in May 1986, at which time our common stock commenced trading on the NASDAQ National Market. In February 1987, we were reincorporated in Delaware and in October 1988, we began listing our common stock on the New York Stock Exchange under the symbol “CY.” On November 12, 2009, we voluntarily moved our stock listing back to the NASDAQ Global Select Market, maintaining the “CY” ticker symbol.

Our corporate headquarters are located at 198 Champion Court, San Jose, California 95134, and our main telephone number is (408) 943-2600. We maintain a website at [www.cypress.com](http://www.cypress.com). The contents of our website are not incorporated into, or otherwise to be regarded as part of, this Annual Report on Form 10-K.

Our fiscal 2012 ended on December 30, 2012, fiscal 2011 ended on January 1, 2012 and fiscal 2010 ended on January 2, 2011.

#### Business Segments

As of the end of fiscal 2012, our organization included the following business segments:

<u>Business Segments</u>	<u>Description</u>
Memory Products Division	A division that focuses on static random access memory (“SRAM”), nonvolatile business units and general-purpose programmable clocks. Its purpose is to enhance our No. 1 position in SRAMs and invent new and related products.
Data Communications Division	A division focused solely on USB controllers, WirelessUSB <sup>™</sup> and West Bridge <sup>®</sup> peripheral controllers for handsets, PCs and tablets. Its purpose is to enhance our No. 1 position in USB.
Programmable Systems Division (“PSD”)	A division focusing primarily on our PSoC <sup>®</sup> and PSoC-based products. This business segment focuses on (1) the PSoC platform family of devices including PSoC 1, PSoC 3 and PSoC 5 and all derivatives, (2) PSoC-based user interface products such as CapSense <sup>®</sup> touch-sensing and TrueTouch <sup>®</sup> touchscreen products, (3) PSoC-based module solutions including Trackpad and Ovation <sup>™</sup> Optical Navigation Sensors (“ONS”) and (4) automotive products. PSD is chartered to become No. 1 in CapSense and TrueTouch and chartered to build the base PSoC franchise.



Business Segments	Description
Emerging Technologies Division (“ETD”)	Our “startup” division includes AgigA Tech Inc. and Deca Technologies Inc., both of which are subsidiaries of Cypress. ETD also includes our foundry business and other development-stage activities. Note that certain businesses, such as our trackpad business, have “graduated” from ETD as it was reported in 2011 into operating divisions.

For additional information on our segments, see Note 19 of Notes to Consolidated Financial Statements under Item 8.

## Business Strategies

Cypress is committed to managing its expenses and to maintaining a strong balance sheet. We have successfully transitioned many of our business operations to lower-cost centers, including India, the Philippines and China. In addition, we are using foundry partners for more of our manufacturing needs.

In 2010, Cypress continued to focus sales, marketing, and product development on its “touch” business, which includes touchscreens and button-replacement technologies. As a result, we realized significant revenue growth for our PSoC-based TrueTouch touchscreen controllers and CapSense capacitive-touch-sensing products, primarily in the handset market. We also realized our first design win in ONS, which provides unique touch sensors for mobile phones. As a result, Cypress’s handset revenue increased by more than 30 percent, year over year.

In 2011, Cypress introduced three important products: Gen4 TrueTouch controllers, EZ-USB® FX3™ controllers for USB 3.0, and the West Bridge® Benicia controller, which brings USB 3.0 capability to mobile devices. All of these families have received positive customer acceptance and continue to add incremental revenue.

In 2012, Cypress acquired Ramtron International Corporation (“Ramtron”) for a purchase price of \$107.9 million. Ramtron is a leading provider of high-speed, non-volatile memory based in Colorado Springs, Colorado. Ramtron’s F-RAM based products complement Cypress’s nvSRAM product line, enabling Cypress to offer the industry’s most comprehensive high-speed, non-volatile memory offering for mission-critical applications. Cypress also introduced the PSoC 5LP Programmable System-on-Chip family of low-power, precision analog devices for a wide variety of industrial, medical and consumer applications. The Company also delivered a new TrueTouch family called TrueTouch Gen4X, which offers the industry’s best touchscreen performance in the presence of noise sources such as low-cost phone chargers.

In fiscal 2013, Cypress will continue to pursue the following key strategies:

- *Drive profitability.* Driving profitability and a high return on investment for our stockholders is our first priority. Toward that end, Cypress has implemented a tight, corporate-wide focus on gross margin and operating expenses. Over the past several years, Cypress has continued to move its operations to low-cost centers in India, the Philippines and China and implemented a flexible manufacturing model. As a result of these efforts, Cypress has been able to offer impressive shareholder value by repurchasing more than \$911.6 million in stock since 2010, and by raising the quarterly dividend to \$0.11 per share starting in April 2012.
- *Drive programmability.* We believe our proprietary programmable technologies and programmable product leadership, led by our flagship PSoC family of devices, represents an important competitive advantage for us. Driven by current and anticipated demand, we continue to define, design and develop new programmable products and solutions that offer our customers increased flexibility and efficiency, higher performance, and higher levels of integration with a focus on analog functionality.

- *Extend technology leadership and drive PSoC® proliferation.* The most important step of our programmability initiative is to drive PSoC® adoption in large market segments. PSoC® devices can be used in applications ranging from cell phones, MP3 players, tablets and Ereaders to appliances and cars, etc. The product's easy-to-use programming software and development kits can facilitate rapid adoption across many different platforms.
- *Focus on large and growing markets.* We will continue to pursue business opportunities in large and growing markets, including handheld and human interface/consumer devices, personal health monitoring, industrial sensing and control, mobile accessories, automotive, and system management.
- *Collaborate with customers to build system-level solutions.* We work closely with customers from initial product design through manufacturing and delivery. Our sales, customer and technical support, product marketing and development efforts are organized to optimize our customers' design efforts, helping them achieve product differentiation and improve time-to-market. Our engineering expertise is focused on developing whole product solutions, including silicon, software and reference designs.
- *Leverage flexible manufacturing.* Our manufacturing strategy combines capacity from leading foundries with output from our internal manufacturing facilities. This initiative allows us to meet rapid swings in customer demand while lessening the burden of high fixed costs, a capability that is particularly important in high-volume consumer markets that we serve with our leading programmable product portfolio.
- *Identify and exit legacy or non-strategic, underperforming businesses.* A focused business will allow us to better achieve our current objectives. Over the past three years, we have divested certain business units that were inconsistent with our future business initiatives and long-term plans. Exiting these businesses has allowed us to focus our resources and efforts on our core programmable and proprietary business model. Our recent divestiture of Cypress EnviroSystems is an example of Cypress executing on this strategy. As part of our growth strategy, we will continue to review our business units to ensure alignment with our short and long-term goals.
- *Pursue complementary strategic relationships.* Complementary acquisitions can expand our markets and strengthen our competitive position. As part of our growth strategy, we continue to selectively assess opportunities to develop strategic relationships, including acquisitions, investments and joint development projects with key partners and other businesses. We also have a unique venture based start up model that is part of our Emerging Technologies division and we expect to continue to make significant investments in current ventures as well as new ventures.

As we continue to implement our strategies, there are many internal and external factors that could impact our ability to meet any or all of our objectives. Some of these factors are discussed under Item 1A.

## **Product/Service Overview**

### Programmable Solutions Division ("PSD"):

The Programmable Solutions Division designs and develops solutions for many of the world's leading end-product manufacturers. Its programmable product offerings are the linchpin of our programmable solutions strategy. This division's products include PSoC devices, CapSense, and TrueTouch touch-sensing/touchscreen products, module-based solutions including optical navigations sensors and trackpads, and automotive products. PSoC® products are used in various consumer applications such as MP3 players, mass storage, household appliances, laptop computers and toys. The TrueTouch™ touchscreen products are used in mobile phones, tablets, GPS, digital cameras and other mobile systems. CapSense devices are used in any application that employs buttons or sliders.

The following table summarizes the markets and applications related to our products in this segment:

Products	Markets	Applications
PSoC <sup>®</sup> 1, PSoC <sup>®</sup> 3 and PSoC <sup>®</sup> 5	Consumer, handsets, industrial, medical, communications, automotive	Digital still and video cameras, appliances, handheld devices, notebook computers, LCD monitors, medical devices, mice, keyboards, industrial, toys, mobile accessories and e-Bikes.
TrueTouch	Consumer, computation, handsets, communication, gaming, automotive	Mobile handsets, tablets, portable media players, cameras, autos, video games, GPS systems, keyboards and other applications.
CapSense	Consumer, industrial, computation, white goods, communication, automotive	Notebook computers and PCs, appliances, handheld devices, automotive control pads/media centers, digital cameras, toys, consumer products and many other applications.
Trackpad Solutions	PCs, consumer	Cypress has applied its capacitive sensing expertise to the trackpad market for laptop computers. Trackpads offer cursor control and other functions, and Cypress's solution has been adopted by multiple PC manufacturers.
Optical Navigation Sensors	PC peripherals, consumer	Our OvationONS technology is used in smartphones, tablet PCs, remote controls, e-book readers, wired and wireless mice and industrial applications.

*PSoC<sup>®</sup> Programmable System-on-Chip products.* Our PSoC<sup>®</sup> products are highly integrated, high-performance mixed-signal devices with an on-board microcontroller, programmable digital and analog blocks, SRAM and flash memory. They provide a low-cost, single-chip solution for a variety of consumer, industrial, medical, and system management applications. A single PSoC<sup>®</sup> device can potentially integrate as many as 100 peripheral functions saving customers design time, board space, power consumption, and system costs. Because of its programmability, PSoC<sup>®</sup> allows customers to make modifications at any point during the design cycle, providing unmatched flexibility.

Cypress's PSoC<sup>®</sup> 1 device delivers performance, programmability and flexibility with a cost-optimized 8-bit M8 CPU subsystem. PSoC<sup>®</sup> 3 uses an 8-bit, Intel<sup>®</sup> 8051-based microcontroller with 7.5 times more computing power than PSoC<sup>®</sup> 1. The 32-bit, ARM<sup>®</sup>-Cortex<sup>™</sup>-based PSoC<sup>®</sup> 5 has 25 times more computing power than PSoC<sup>®</sup> 1. The analog-to-digital converters on PSoC<sup>®</sup> 3 and PSoC<sup>®</sup> 5 are 256 times more accurate and 10 to 30 times faster than PSoC<sup>®</sup> 1, and there are 10 times more programmable logic gates available. PSoC<sup>®</sup> Creator<sup>™</sup> is a unique design tool that allows engineers to use intuitive schematic-based capture and dozens of certified, firmware-defined, pre-packaged peripherals. In 2011, Cypress introduced PSoC<sup>®</sup> Creator<sup>™</sup> 2.0, which offers compatibility with popular third-party compilers. It also announced multiple design wins with new customers. Cypress shipped its 1.5 billionth PSoC<sup>®</sup> device in 2012, and its online community for developers of PSoC<sup>®</sup> and other products ([www.cypress.com/go/community](http://www.cypress.com/go/community)) featuring technical forums, blogs and videos grew to over 60,000 registered users. In December 2012, Cypress hosted *PSoC World*, an online tradeshow that attracted more than 5,000 attendees.

*TrueTouch Touchscreen Solutions.* TrueTouch is a single-chip touchscreen solution that can interpret the inputs of more than 10 fingers from all areas of the screen simultaneously. This enables designers to create new usage models for products such as mobile handsets, tablets, digital camers, portable media players ("PMPs"), GPS and other products. The TrueTouch family also includes devices that perform traditional touchscreen functions including interpreting single touches, and gestures such as tap, double-tap, pan, pinch, scroll, and

rotate. In 2012, Cypress introduced the Gen4X family of TrueTouch controllers, which delivers the industry’s best noise performance along with a host of exclusive features. We also shipped new, low-cost single-layer sensor technologies that enable manufacturers to replace resistive screens with capacitive screens. We are shipping products from the TrueTouch family into many of the world’s leading cell phone Original Equipment Manufacturers (“OEM”).

*CapSense.* Our CapSense capacitive touch-sensing solutions replace mechanical switches and controls with simple, touch-sensitive controls by detecting the presence or absence of a conductive object (such as a finger) and measuring changes in capacitance. This technology lends itself equally well to buttons, sliders, touchpads, touchscreens and proximity sensors, taking industrial design possibilities to a much higher level. The CapSense family supports all different ranges of general purpose inputs/outputs, buttons and slider devices. Cypress’s CapSense devices feature SmartSense™ technology, an automatic tuning solution for that dynamically detects and adjusts a system’s capacitive-sensing parameters, eliminating the need for manual tuning. Cypress has replaced more than 4 billion buttons with CapSense technology and is the worldwide capacitive sensing market share leader in handsets.

Data Communications Division (“DCD”):

The Data Communications Division focuses solely on USB controllers, WirelessUSB™ and West Bridge® peripheral controllers for handsets, PCs and tablets. Its purpose is to enhance our No. 1 position in USB. USB is used primarily in PC and peripheral applications and is finding increased adoption rates in consumer devices such as MP3 players, mobile handsets and set-top boxes.

The following table summarizes the markets and applications related to our products in this segment:

<u>Products</u>	<u>Markets</u>	<u>Applications</u>
USB controllers	PC peripherals, consumer electronics	Printers, cameras, industrial equipment, mice, keyboards, handheld devices, gamepads and joysticks, VoIP phones, headsets, presenter tools, dongles, point of sale devices and bar code scanners.
Peripheral bridge controllers	Consumer, mobile handsets	Cellular phones, portable media players, personal digital assistants, digital cameras and printers.
WirelessUSB	PC peripherals	Mice, keyboards, wireless headsets, consumer electronics, gamepads, remote controllers, toys and presenter tools.

*USB Controllers.* Cypress is the market leader in USB with more than one billion devices shipped. USB provides the primary connection between a PC and peripherals, including keyboards, mice, printers, joysticks, scanners and modems. It is also used to connect various non-PC systems, such as handheld games, digital still cameras and MP3 players. The USB standard facilitates a “plug-and-play” architecture that enables instant recognition and interoperability when a USB-compatible peripheral is connected to a system. We offer a full range of USB solutions, including low-speed (1.5 Mbps), full-speed (12 Mbps), high-speed (480 Mbps) and now “Super Speed” (up to 5 Gbps) USB products. We also offer a variety of USB hubs, transceivers, serial interface engines and embedded-host products for a broad range of applications.

*West Bridge® Peripheral Bridge Controllers.* Our West Bridge products enable direct connection between peripherals, creating ultra-fast transfers while offloading the main processor from data-intensive operations. The West Bridge family complements the main processor by adding support for next generation and latest standards and allowing simultaneous transfers between peripherals and processing elements. West Bridge controllers are three-ported devices designed specifically for handsets to provide a direct path from PC to handset mass storage, freeing baseband/applications processor resources by limiting its involvement in these high-density transfers. Additionally, West Bridge creates simultaneous usage models by adding dedicated paths between the three ports to literally create multiple usage models such as using the handset as a modem, while downloading multimedia files, and playing music. The West Bridge Benicia product was the first controller to bring USB 3.0 speed (up to 5 Gbps) to mobile handsets.

*WirelessUSB™*. Designed for short-range wireless connectivity, WirelessUSB enables personal computer peripherals, gaming controllers, remote controls, toys, and other point-to-point or multipoint-to-point applications to “cut the cord” with a low-cost, 2.4-GHz wireless solution. The WirelessUSB system acts as a USB human interface device, so the connectivity is transparent to the designer at the operating system level. WirelessUSB also operates as a simple, cost-effective wireless link in a host of other applications including industrial, consumer, and medical markets. Cypress introduced WirelessUSB NL in 2011, which offers very low power consumption for high-volume markets.

Memory Products Division (“MPD”):

Our Memory Products Division designs and manufactures SRAM products and nonvolatile SRAMs (“nvSRAM”s) which are used to store and retrieve data in networking, wireless infrastructure and handsets, computation, consumer, automotive, industrial and other electronic systems. Cypress is the world’s No.1 supplier of SRAMs due to its broad portfolio of high-performance, synchronous SRAMs, consolidation within the supply base and additional share gains with strategic global customers. Our memory products target a variety of markets including networking, telecommunications, wireless communications and consumer applications. In 2011, we reaffirmed our commitment to the SRAM market with investments in new product development for next generation of high-performance synchronous SRAMs to extend the QDR architecture. We have also completed a major capacity expansion with one of our foundry partners that triples the capacity for our advanced 65-nm SRAM products with very low lead-times. In addition, we are also investing in a new wafer manufacturing process technology and expanding our patented “autoline” packaging and test capability that dramatically cuts our packaging time and cost. In 2012, Cypress acquired Ramtron to add to our non-volatile memory portfolio.

Our MPD also includes timing technology products and specialty memory offerings.

The following table summarizes the markets and applications related to our products in this segment:

<u>Products</u>	<u>Markets</u>	<u>Applications</u>
Asynchronous SRAMs	Consumer, networking	Consumer electronics, switches and routers, automotive, peripheral and industrial electronics.
Synchronous SRAMs	Base station, networking	Wireline networking, wireless base stations, high bandwidth applications and industrial electronics.
nvSRAMs	Servers, industrial	Redundant array of independent disk servers, point of sale terminals, set-top boxes, copiers, industrial automation, printers, single-board computers and gaming.
F-RAMs	Automotive, medical	Smart electric meters, aerospace, medical systems, automotive, industrial controls, electronic point-of-sale terminals, printers and wireless (RFID) memory.
Dual-port Memories	Networking, telecommunication	Medical and instrumentation, storage, wireless infrastructure, military communications, image processors and base stations.
First-in, first-out (“FIFO”) Memories	Video, data communications, telecommunications, networking	Video, data communications, telecommunications, and network switching/routing.
Programmable clocks	Communications, computation	Set-top boxes, copiers, printers, HDTV, industrial automation, printers, single-board computers, IP phones, storage devices, servers and routers.
RoboClock® buffers	Communications	Base stations, high-end telecom equipment (switches, routers), servers and storage.

*Asynchronous SRAMs*. We manufacture a wide selection of fast asynchronous and micropower SRAMs with densities ranging from 16 Kbits to 64 Mbits. These memories are available in many combinations of bus widths,

packages and temperature ranges including automotive. They are ideal for use in point-of-sale terminals, gaming machines, network switches and routers, IP phones, IC testers, DSLAM Cards and various automotive applications. Additionally, we introduced the market's first 32-bit and 64-bit fast asynchronous SRAMs targeting storage servers, switches, routers, test and military equipment.

*Synchronous SRAMs.* Our high-speed synchronous SRAMs include standard synchronous pipelined, No Bus Latency ("NoBL"), Quad Data Rate, and Double Data Rate SRAMs, and are typically used in networking applications. NoBL synchronous SRAMs are optimized for high-speed applications that require maximum bus bandwidth up to 250 MHz, including those in the networking, instrumentation, video and simulation businesses. Double Data Rate ("DDR") SRAMs target network applications and servers that operate at data rates up to 550 MHz. Quad Data Rate™ ("QDR"®) products are targeted toward next-generation networking applications, particularly switches and routers that operate at data rates beyond 550 MHz and offer twice the bus bandwidth of DDR SRAMs. In 2011, Cypress introduced the industry's first 65-nm QDR and DDR SRAMs. The 144-Mbit and 72-Mbit devices, developed with foundry partner UMC, feature the industry's fastest clock speeds and operate at half the power of their 90-nm predecessors. They are ideal for networking, medical imaging and military signal processing.

*nvSRAMs.* nvSRAMs are products that operate similar to standard asynchronous SRAM and reliably store data into an internal nonvolatile array during unanticipated power downs. The competitive advantage of an nvSRAM is infinite endurance and much faster read/write speed than a serial flash or EEPROM. Additionally, these high-speed nonvolatile SRAM devices can store data for more than 20 years without battery backup. These memories are ideal for redundant array of independent disks ("RAID") storage arrays, metering applications, multifunction printers and other industrial applications, such as PLCs. Additionally, we have our 1-Mbit serial nonvolatile SRAM family and our 4-Mbit and 8-Mbit parallel nvSRAMs with an integrated real-time clock, providing failsafe battery-free data backup in mission-critical applications.

*F-RAMs.* Cypress's new F-RAM memories, offer extremely low power with the same non-volatility as nvSRAM products. F-RAM memory cells are immune to gamma radiation and EMI, making them well-suited to certain aerospace and medical systems. Other applications include automotive, smart electric meters, industrial controls, electronic point-of-sale terminals, printers and wireless (RFID) memory.

*Dual-Port Memories.* Dual ports, which can be accessed by two different processors or buses simultaneously, target shared-memory and switching applications, including networking switches and routers, cellular base stations, mass-storage devices and telecommunications equipment. We offer a portfolio of more than 160 synchronous and asynchronous dual-port interconnects ranging in densities from 8 Kbits to 36 Mbits with speeds of up to 250 MHz. Our dual ports are the compelling solutions for interprocessor communication in a broad range of applications. For high-volume multiprocessor applications (wireless handsets, PDAs, consumer) we offer the MoBL dual port, providing a low cost, quick time-to-market interconnect solution with the industry's lowest power-consumption.

*FIFO Memories.* FIFOs are used as a buffer between systems operating at different frequencies. Our high-performance FIFO products provide the ideal solution to interconnect problems such as flow control, rate matching, and bus matching. Our FIFO portfolio is comprised of more than 100 synchronous and asynchronous memories in a variety of speeds, bus widths, densities and packages. Using industry-standard pinouts, these products are easily integrated into new and existing designs. Unidirectional, bidirectional, tri-bus and double sync configurations are available with built-in expansion logic and message-passing capabilities for various markets including video, data communications, telecommunications and network switching/routing. In 2011, Cypress introduced the industry's highest density FIFOs at 72 Mbits.

*Programmable Clocks.* Programmable timing solutions such as our InstaClock device combine high performance with the flexibility and fast time to market of field-programmable devices at a cost that is competitive against custom clocks at equivalent volumes. Working with our easy-to-use CyberClocks software, designers can optimize device parameters such as drive strength, phased-lock loop bandwidth and crystal input capacitive loading.

Our programmable clocks are ideal for devices requiring multiple frequencies including Ethernet, PCI, USB, HDTV, and audio applications. Additionally, the FleXO™ family of high-performance clock generators can be instantly programmed in the factory or field to any frequency up to 650 MHz, accelerating time to market and improving manufacturing quality.

*RoboClock Clock Buffers.* Our RoboClock family of clock buffers feature programmable output skew, programmable multiply/divide factor, and user-selectable redundant reference clocks that provide fault tolerance. Designers can control output skew and multiply and divide factors to help accommodate last-minute design changes. RoboClock offers a high-performance timing solution for designers of communications, computation and storage networking applications.

#### Emerging Technologies:

Cypress's Emerging Technology Division consists of businesses outside our core semiconductor business. It includes majority-owned subsidiaries AgigA Tech, Inc., Deca Technologies, Inc., foundry services, other development stage activities and certain corporate expenses.

*AgigA Tech, Inc.* AgigA Tech, a majority-owned and fully independent subsidiary of Cypress, is an industry pioneer in the development of high-speed, high-density, battery-free non-volatile memory solutions. Its flagship product, AGIGARAM™, merges NAND Flash, DRAM and an ultracapacitor power source into a highly reliable non-volatile memory subsystem, delivering unlimited read/write performance at RAM speeds, while also safely backing up all data when power is interrupted. The patent pending approach couples innovations in power management, high-speed data movement and systems knowledge, while leveraging high volume readily available memory technologies to provide a unique non-volatile solution scalable to very high densities. In 2011, AgigA Tech won a Red Herring Top 100 award.

*Deca Technologies, Inc. ("Deca").* Deca is a majority-owned and fully independent subsidiary of Cypress. Headquartered in Tempe, AZ., and with global capabilities, Deca has pioneered a breakthrough approach to wafer level packaging and interconnect technology inspired by SunPower Corporation's unique solar wafer fabrication methodology. Deca's initial product offering includes a series of wafer level chip scale packaging ("WLCSP") solutions serving several of the top 25 semiconductor producers. Deca's approach enables industry leading cycle times, flexibility and value for WLCSP which is one of the semiconductor industry's fastest growing electronic interconnect technologies.

#### **Acquisition**

In November 2012, we completed the acquisition of Ramtron and purchased all of Ramtron's outstanding common stock at a purchase price of \$3.10 per share for a total cash payment of \$100.9 million, equity consideration totaling \$1.8 million and incurred direct transaction costs of \$15.3 million. This \$15.3 million of acquisition related expenses includes legal, banker, severance expenses and costs related to the acceleration of terminated employee stock awards. All existing Ramtron equity based incentive plans were terminated upon the completion of the acquisition.

See Note 2 of Notes to Consolidated Financial Statements under Item 8 for further discussion.

#### **Divestitures**

On December 19, 2012, we completed the divestiture of our wholly-owned subsidiary Cypress EnviroSystems ("EnviroSystems") and we received nominal consideration that is dependent upon future performance. EnviroSystems was part of our ETD segment and as a result of the sale we recorded a loss of \$1.6 million in "(Gain) loss on divestiture," on the Consolidated Statement of Operations.

As part of Cypress's continued efforts to focus on programmable products including our flagship PSoC® programmable system-on-chip solutions and our TrueTouch™ touch-sensing controllers, we divested our image sensors product families and sold them to ON Semiconductor Corporation on February 27, 2011 in an all cash transaction for a consideration of approximately \$34 million.

For additional information on these divestitures, see Note 3 of Notes to Consolidated Financial Statements under Item 8.

## **Manufacturing**

Our core manufacturing strategy—“flexible manufacturing”—combines capacity from foundries with output from our internal manufacturing facilities. This initiative allows us to meet rapid swings in customer demand while lessening the burden of high fixed costs, a capability that is particularly important in high-volume consumer markets that we serve with our leading programmable product portfolio.

We currently manufacture approximately 69% of our semiconductor products at our wafer manufacturing facility in Bloomington, Minnesota. External wafer foundries, mainly in Asia, manufactured the balance of our products and we expect that our wafer foundry partners will continue to increase their manufacturing as a percentage of total output.

We conduct assembly and test operations at our highly automated assembly and test facility in the Philippines. This facility accounts for approximately 36% of the total assembly output and 36% of the total test output. Various subcontractors in Asia performed the balance of the assembly and test operations.

Our facility in the Philippines performs assembly and test operations manufacturing volume products and packages where our ability to leverage manufacturing costs is high. This facility has ten fully integrated, automated manufacturing lines enabling complete assembly and test operations. These autolines require fewer people to run and have shorter manufacturing cycle times than conventional assembly/test operations, which enable us to respond more rapidly to changes in demand.

We have a strategic foundry partnership with Grace Semiconductor Manufacturing Corporation (“Grace”), located in Shanghai, China. Our agreement with them transferred certain proprietary process technologies to Grace and provided additional production capacity to augment output from our manufacturing facilities. Since 2007, when we completed the transfer of our 0.35-micron SONOS, 0.13-micron SRAM and LOGIC processes and 0.09-micron SRAM, we have been purchasing products from Grace that are manufactured using these processes. In conjunction with our partnership with Grace, we made certain pre-payments to them in fiscal 2011 to secure a certain supply of wafers. The pre-payments are applied to purchases of wafers from Grace over a period of two years ending February 22, 2013. As of December 30, 2012, the unapplied pre-payment balance was approximately \$7.3 million.

We also have a strategic foundry partnership with United Microelectronics Corporation (“UMC”), located in Taiwan. We use UMC’s 65nm process to produce our leading edge SRAM products which we have been shipping since 2008. Since 2008, we have continuously introduced higher density SRAM products up to 144Mb. Additionally, we have utilized UMC’s 65nm baseline to create derivative processes and products. These derivatives include an embedded flash process to support the next generation programmable system-on-chip and nvSRAM products as well as a derivative utilized to manufacture our USB 3.0 controller.

## **Manufacturing Alliances**

As part of our acquisition of Ramtron, we acquired a commercial manufacturing agreement for F-RAM products with Texas Instruments (“TI”). The agreement was entered into in 2007 and amended in 2011 and 2012. Under that agreement, the Company provides certain design, testing and other activities associated with product development, and TI provides certain foundry and related services. As amended on November 30, 2012, the agreement provides for automatic renewals unless written notice of termination is given prior to the end of any renewal period. If notice of termination is given, the agreement terminates one year thereafter and the Company may place last orders and take delivery of product during the following year. The agreement contains various obligations of the parties, including obligations for us regarding minimum orders and negotiated pricing of products we purchase.



## **Research and Development**

Research and development efforts are focused on the development and design of new semiconductor products, as well as the continued development of advanced software platforms primarily for our programmable solutions. Our goal is to increase efficiency in order to maintain our competitive advantage. Our research and development organization works closely with our manufacturing facilities, suppliers and customers to improve our semiconductor designs and lower our manufacturing costs. During fiscal 2012, 2011, and 2010, research and development expenses totaled \$189.9 million, \$190.0 million, and \$176.8 million, respectively.

We have both central and division-specific design groups that focus on new product creation and improvement of design methodologies. These groups conduct ongoing efforts to reduce design cycle time and increase first pass yield through structured re-use of intellectual property blocks from a controlled intellectual property library, development of computer-aided design tools and improved design business processes. Design and related software development work primarily occurs at design centers located in the United States, Europe, India and China.

## **Customers, Sales and Marketing**

We sell our semiconductor products through several channels: sales through global domestically-based distributors; sales through international distributors and manufacturing representative firms; and sales by our sales force to direct original equipment manufacturers and their manufacturers. Our marketing and sales efforts are organized around five regions: North America, Europe, Japan, Greater China, and the rest of Asia. We also have a strategic-account group and a contract-manufacturing group which are responsible for specific customers with worldwide operations. We augment our sales effort with field application engineers, specialists in our products, technologies and services who work with customers to design our products into their systems. Field application engineers also help us identify emerging markets and new products.

Outstanding accounts receivable from three of our distributors, accounted for 12.2%, 11.9% and 10.2%, respectively, of our consolidated accounts receivable as of December 30, 2012. Outstanding accounts receivable from three of our distributors, accounted for 14.1%, 13.9% and 11.1%, respectively, of our consolidated accounts receivable as of January 1, 2012.

Revenue generated through Avnet, Inc., Macnica Inc., and Arkian, three of our distributors, accounted for 13.5%, 12.4% and 10.1% respectively, of our consolidated revenue for fiscal 2012. Samsung Electronics (“Samsung”), an end customer, purchases our products from certain of our distributors. Shipments to Samsung accounted for 10.8% of our consolidated revenue for fiscal 2012.

Revenue generated through Avnet Inc. and Weikeng Industrial Co. Ltd, two of our distributors accounted for 12.8% and 11.2%, respectively, of our consolidated revenue for fiscal 2011. Shipments to Samsung accounted for 10.0% of our consolidated revenue for fiscal 2011.

Revenue generated through Avnet Inc. and Arrow Electronics, Inc., two of our distributors accounted for 15% and 10%, respectively, of our consolidated revenue for fiscal 2010. We had no end customers accounting for 10% or greater of our consolidated revenue for fiscal 2010.

## **Backlog**

Our sales typically rely upon standard purchase orders for delivery of products with relatively short delivery lead times. Customer relationships are generally not subject to long-term contracts. However, we have entered into long-term supply agreements with certain customers. These long-term supply agreements generally do not contain minimum purchase commitments. Products to be delivered and the related delivery schedules under these long-term contracts are frequently revised to reflect changes in customer needs. Accordingly, our backlog at any particular date is not necessarily representative of actual sales for any succeeding period and we believe that our backlog is not a meaningful indicator of future revenues.

## **Competition**

The semiconductor industry is intensely competitive and continually evolving. This intense competition results in a challenging operating environment for most companies in this industry. This environment is characterized by the potential erosion of product sale prices over the life of each product, rapid technological change, limited product life cycles, greater brand recognition and strong domestic and foreign competition in many markets. Our ability to compete successfully depends on many factors, including:

- our success in developing new products and manufacturing technologies;
- delivery, performance, quality and price of our products;
- diversity of our products and timeliness of new product introductions;
- cost effectiveness of our design, development, manufacturing and marketing efforts;
- quality of our customer service, relationships and reputation;
- overall success with which our customers market their products and solutions that incorporate our products; and
- number and nature of our competitors and general economic conditions.

We face competition from domestic and foreign semiconductor manufacturers, many of which have advanced technological capabilities and have increased their participation in the markets in which we operate. We compete with a large number of companies primarily in the telecommunications, networking, data communications, computation and consumer markets. Companies who compete directly with our semiconductor businesses include, but are not limited to, Altera, Analog Devices, Atmel, Freescale, Integrated Device Technology, GSI Technology, Integrated Silicon Solution, Inc., Lattice Semiconductor, Linear Technology, Maxim Integrated Products, Microchip Technology, Renesas, Samsung, Silicon Laboratories, Synaptics, Texas Instruments and Xilinx.

## **Environmental Regulations**

We use, generate and discharge hazardous chemicals and waste in our research and development and manufacturing activities. United States federal, state and local regulations, in addition to those of other foreign countries in which we operate, impose various environmental rules and obligations, which are becoming increasingly stringent over time, intended to protect the environment and in particular regulate the management and disposal of hazardous substances. We also face increasing complexity in our product design as we adjust to new and future requirements relating to the materials composition of our products, including the restrictions on lead and other hazardous substances that apply to specified electronic products put on the market in the European Union (Restriction on the Use of Hazardous Substances Directive 2002/95/EC, also known as the “RoHS Directive”) and similar legislation in China and California. We are committed to the continual improvement of our environmental systems and controls. However, we cannot provide assurance that we have been, or will at all times be, in complete compliance with all environmental laws and regulations. Other laws impose liability on owners and operators of real property for any contamination of the property even if they did not cause or know of the contamination. While to date we have not experienced any material adverse impact on our business from environmental regulations, we cannot provide assurance that environmental regulations will not impose expensive obligations on us in the future, or otherwise result in the incurrence of liability such as the following:

- a requirement to increase capital or other costs to comply with such regulations or to restrict discharges;
- liabilities to our employees and/or third parties; and
- business interruptions as a consequence of permit suspensions or revocations or as a consequence of the granting of injunctions requested by governmental agencies or private parties.

## **Intellectual Property**

We have an active program to obtain patent and other intellectual property protection for our proprietary technologies, products and other inventions that are aligned with our strategic initiatives. We rely on a

combination of patents, copyrights, trade secrets, trademarks and proprietary information to maintain and enhance our competitive position in the domestic and international markets we serve. As of the end of fiscal 2012, we had approximately 1,913 issued patents and approximately 850 additional patent applications on file domestically and internationally. In addition, in fiscal 2013, we are preparing to file up to 150 new patent applications in the United States and up to 40 foreign applications in countries such as China, Taiwan, Korea, Europe and India. The average remaining life of our patent portfolio is approximately 10 years.

In addition to factors such as innovation, technological expertise and experienced personnel, we believe that patents are increasingly important to remain competitive in our industry, defend our position in existing markets and to facilitate the entry of our proprietary products, such as PSoC®, into new markets. As our technologies are deployed in new applications and we face new competitors, we will likely subject ourselves to new potential infringement claims and discover third party infringement of our intellectual property. Patent litigation, if and when instituted against us, could result in substantial costs and a diversion of our management's attention and resources. However, we are committed to vigorously defending and protecting our investment in our intellectual property. Therefore, the strength of our intellectual property program, including the breadth and depth of our portfolio, will be critical to our success in the new markets we intend to pursue.

In connection with our divestiture of unaligned and non-strategic businesses, we performed an analysis of our intellectual property portfolio to ensure we were deriving the full value of our assets. As a result, we continue to evaluate certain unaligned patents as well as other monetization models for our patent portfolio.

### **Financial Information about Segments and Geographic Areas**

Financial information about segments and geographic area is incorporated herein by reference to Note 19 of Notes to Consolidated Financial Statements under Item 8.

International revenues have historically accounted for a significant portion of our total revenues. Our manufacturing and certain finance operations in the Philippines, as well as our sales and support offices and design centers in other parts of the world, face risks frequently associated with foreign operations, including, but not limited to:

- currency exchange fluctuations, including the weakening of the U.S. dollar;
- the devaluation of local currencies;
- political instability;
- labor issues;
- changes in local economic conditions;
- import and export controls;
- potential shortage of electric power supply; and
- changes in tax laws, tariffs and freight rates.

To the extent any such risks materialize, our business, financial condition or results of operations could be seriously harmed.

### **Employees**

As of December 30, 2012, we had approximately 3,600 employees worldwide, slightly up from approximately 3,400 employees as of January 1, 2012 mainly from our acquisition of Ramtron in Q4 as well as hiring under our new college graduate program. Geographically, approximately 1,400 employees were located in the United States, 1,000 employees were located in the Philippines, 650 employees were located in India and 550 employees were located in other countries. Of the total employees, approximately 1,700 employees were associated with manufacturing, 1,000 employees were associated with selling, general and administrative functions, and 900 employees were associated with research and development.

None of our employees are represented by a collective bargaining agreement, nor have we ever experienced organized work stoppages.

## Executive Officers of the Registrant

Certain information regarding each of our executive officers is set forth below:

<u>Name</u>	<u>Age</u>	<u>Position</u>
T. J. Rodgers	63	President, Chief Executive Officer and Director
Brad W. Buss	48	Executive Vice President, Finance and Administration and Chief Financial Officer
Sabbas A. Daniel	49	Executive Vice President, Quality
Alan Hawse	43	Executive Vice President, Software Development
Paul D. Keswick	54	Executive Vice President, New Product Development, Engineering, IT
Badri Kothandaraman	40	Executive Vice President, Data Communications Division and Executive Director, Cypress India Limited
Dana C. Nazarian	45	Executive Vice President, Memory Products Division
J. Augusto De Oliveira	48	Executive Vice President, Chief Technical Officer
Hassane El-Khoury	33	Executive Vice President, Programmable Systems Division
Christopher A. Seams	49	Executive Vice President, Sales and Marketing
Minh Pham	53	Executive Vice President, World Wide Manufacturing and Operations
Thomas Surette	49	Executive Vice President, Human Resources

**T.J. Rodgers** is a founder of Cypress and has been a Director and its President and Chief Executive Officer since 1982. Mr. Rodgers sits on the board of directors of Cypress's internal subsidiaries as well as Bloom Energy, a privately held fuel cell company. Mr. Rodgers was also a member of the Board of Trustees of Dartmouth College until June 2012.

**Brad W. Buss** joined Cypress in 2005 as Executive Vice President, Finance and Administration and Chief Financial Officer. Prior to joining Cypress, Mr. Buss served as Vice President of Finance at Altera Corporation, a provider of programmable logic solutions. Mr. Buss spent seven years as a finance executive with Wyle Electronics, a provider of high tech services for aerospace, life sciences and information systems, culminating as Chief Financial Officer and Secretary of the Atlas Services division. Mr. Buss was also a member of Cisco Systems' worldwide sales finance team. In addition, Mr. Buss served as Senior Vice President of Finance and Chief Financial Officer and Secretary at Zaffire, a developer of optical services networking systems. Mr. Buss currently serves as a board member of certain internal subsidiaries as well as CafePress.com and Tesla Motors, both publicly listed companies.

**Sabbas A. Daniel** was appointed Executive Vice President of Quality in 2006. Prior to his current position, Mr. Daniel has held various management positions responsible for Cypress's reliability and field quality organizations. Mr. Daniel joined Cypress in 1998. Prior to joining Cypress, he worked at Samsung in Korea as director of Reliability in the System LSI, memory, LCD, and Alpha microprocessor operations.

**Alan Hawse** was named Executive Vice President of Software Development in October 2011. Mr. Hawse started his career with Cypress in 1991 and held several new product development management and engineering positions that involved electronic design automation, device modeling and new product information systems. Prior to his current position, Mr. Hawse served as Cypress's Vice President of Information Technology.

**Paul D. Keswick** has served as Executive Vice President of New Product Development, Engineering, IT since 1996. Prior to his current position, Mr. Keswick has held various management positions, including Vice President and General Manager for various business divisions. Mr. Keswick has been with Cypress since 1986.

**Badri Kothandaraman** started his career with Cypress in 1995 and was named Executive Vice President of the Data Communications Division in November 2011. In addition to managing DCD, Mr. Kothandaraman also serves as the Executive Director of Cypress Semiconductor Technology India Private Limited. Prior to assuming his current positions, Mr. Kothandaraman held various management roles in memory design, including serving as the Vice President of the Asynchronous, Specialty Memory, Clocks and Non-volatile products business units.

**Dana C. Nazarian** was named Executive Vice President of Memory Products Division in February 2009. Mr. Nazarian started his career with Cypress in 1988. Prior to his current position, Mr. Nazarian held various management positions, which included oversight of significant operations in our Round Rock, Texas facility and Vice President of our Synchronous SRAM business unit.

**J. Augusto De Oliveira** was named Executive Vice President and Chief Technical Officer in 2012. Mr. Oliveira has more than 25 years of experience in R&D management and technology strategy for very-large-scale systems-on-chip. From 1999 to 2005, Mr. Oliveira was Chief Architect and Innovation Manager for the consumer business of Philips Semiconductors. Mr. Oliveira joined Cypress in 2007 as Senior Vice President and CTO of Cypress’s memory and data communications divisions. In late 2008, his role was expanded to include all divisions.

**Hassane El-Khoury** was named Executive Vice president of the Programmable Systems Division in 2012. After working as an engineer at Continental Automotive Systems, he joined Cypress’s automotive business unit and expanded the Company’s presence in the Human-Machine Interface and Body Electronics segments of the automotive marketplace. He currently is responsible for Cypress’s PSoC, touch and automotive businesses.

**Christopher A. Seams** was named Executive Vice President of Sales and Marketing in 2005. Prior to his current appointment, Mr. Seams was Executive Vice President of Manufacturing and Research and Development. Mr. Seams joined Cypress in 1990 and has held a variety of positions in technical and operational management in manufacturing, development and foundry.

**Tom Surette** was named Executive Vice President of Human Resources in September 2008. After working at Philips/Signetics in software, test and product engineering roles, Mr. Surette joined Cypress in July 1990 and has held a series of engineering, manufacturing and technical management, marketing and product development roles. Mr. Surette has served as the Business Unit Director for Micropower SRAM and Synchronous SRAM, the Vice President for Non-Volatile Memory and the Sr. Vice President of Worldwide Operations.

**Minh Pham** was appointed Executive Vice President of WW Manufacturing and Operations in 2012. Prior to his current position, Mr. Pham, who joined Cypress in 1995, held various management positions responsible for Cypress’s manufacturing, test and assembly operations. He ran Cypress’s former fabrication facility in Round Rock, Texas, its current Fab 4 in Bloomington, Minnesota, and the test and assembly operations in the Philippines. Prior to joining Cypress, Mr. Pham held management positions for Mostek Corporation and Philips Semiconductors.

The executive officers of our majority-owned subsidiaries are as follows:

Name	Age	Position
Timothy L. Olson	50	President & Chief Executive Officer, Deca Technologies Inc.
Ronald Sartore	61	Chief Executive Officer, AgigA Tech Inc.

**Timothy L. Olson** founded Deca Technologies, Inc. and has been a Director and its President and Chief Executive Officer since 2009. Prior to establishing Deca Technologies, Mr. Olson was Senior Vice President of Research & Development and the Emerging Technologies businesses with Amkor Technology, a semiconductor company. Mr. Olson was also previously Executive Vice President of Products and Operations at Micro Component Technology, a manufacturer of automatic testing and handling equipment Vice President of Fico b.v., a developer of packaging solutions for the semiconductor industry and was an Operations and Development Manager at Motorola Semiconductor Products Sector. Mr. Olson has held a technical advisory board position with Cypress since 1998.

**Ronald Sartore** was appointed Chief Executive Officer of AgigA Tech, Inc. in 2007. AgigA Tech, Inc. was originally a subsidiary of Simtek Corporation, a public company Cypress acquired in 2008. Mr. Sartore has over 30 years of experience in the computer and semiconductor fields. Prior to his current role, Mr. Sartore served as an Executive Vice President and director of Simtek Corporation. Prior to tenure at Simtek, Mr. Sartore served as a Vice President of several business units at Cypress, which he joined as a result of Cypress’s 1999 acquisition of

Anchor Chips, a company Mr. Sartore founded in 1995. Prior to Anchor Chips, Mr. Sartore held various engineering and management roles at Cheetah International, a supplier of software systems, which he co-founded in 1985.

### **Available Information**

We make available our Annual Reports on Form 10-K, Quarterly Reports on Form 10-Q, Current Reports on Form 8-K and amendments to those reports filed or furnished pursuant to Section 13(a) or Section 15(d) of the Securities Exchange Act of 1934, as amended, free of charge on our website at [www.cypress.com](http://www.cypress.com), as soon as reasonably practicable after they are electronically filed with or furnished to the Securities and Exchange Commission ("SEC"). Additionally, copies of materials filed by us with the SEC may be accessed at the SEC's Public Reference Room at 100 F Street, N.E., Washington, D.C. 20549 or at [www.sec.gov](http://www.sec.gov). For information about the SEC's Public Reference Room, contact 1-800-SEC-0330.

### **ITEM 1A. RISK FACTORS**

***Current unfavorable economic and market conditions, domestically and internationally, may adversely affect our business, financial condition, results of operations and cash flows.***

We have significant customer sales both in the U.S. and internationally. We are also reliant upon U.S. and international suppliers, manufacturing partners and distributors. We are therefore susceptible to adverse U.S. and international economic and market conditions, including the challenging economic conditions that have prevailed and continue to prevail in the U.S. and worldwide. The recent turmoil in the financial markets has resulted in dramatically higher borrowing costs which have made it more difficult (in some cases, prohibitively so) for many companies to obtain credit and fund their working capital obligations. If any of our manufacturing partners, customers, distributors or suppliers experiences serious financial difficulties or ceases operations, our business will be adversely affected. In addition, the adverse impact of the credit crisis on consumers, including higher unemployment rates, is expected to adversely impact consumer spending, which will adversely impact demand for consumer products such as certain end products in which our chips are embedded. For example, in the fourth quarter of fiscal 2012, due to the weakened macro economy, we experienced a revenue shortfall due to a sudden decline in customer orders across all geographies and end markets forecasted by our distribution partners. In addition, prices of certain commodities, including oil, metals, grains and other food products, are volatile and are subject to fluctuations arising from changes in domestic and international supply and demand, labor costs, competition, market speculation, government regulations and periodic delays in delivery. High or volatile commodity prices increase the cost of doing business and adversely affect consumers' discretionary spending. As a result of the difficulty that businesses (including our customers) may have in obtaining credit, the increasing and/or volatile costs of commodities and the decreased consumer spending that is the likely result of the weakness in the general economy, credit market crisis, unemployment and commodities' price volatility, continued global economic and market turmoil are likely to have an adverse impact on our business, financial condition, results of operations and cash flows.

***The trading price of our common stock has been and will likely continue to be volatile due to various factors, some of which are beyond our control, and each of which could adversely affect our stockholders' value.***

The trading price of our common stock has been and will likely continue to be volatile due to various factors, some of which are beyond our control, including, but not limited to:

- quarterly variations in our results of operations or those of our competitors;
- announcements by us or our competitors of acquisitions, new products, significant contracts, design wins, commercial relationships or capital commitments;
- the perceptions of general market conditions in the semiconductor industry and global market conditions;
- our ability to develop and market new and enhanced products on a timely basis;

- any major change in our board or senior management;
- changes in governmental regulations or in the status of our regulatory compliance that impact our business;
- recommendations by securities analysts or changes in earnings estimates concerning us or our customers or competitors;
- announcements about our earnings or the earnings of our competitors that are not in line with analyst expectations;
- the volume of short sales, hedging and other derivative transactions on shares of our common stock;
- economic conditions and growth expectations in the markets we serve;
- credit conditions; and
- changes in our policy regarding dividends or our ability to declare a dividend.

Further, the stock market in general, and the market for technology companies in particular, have experienced extreme price and volume fluctuations. These broad market and industry factors may seriously harm the market price of our common stock, regardless of our actual operating performance. In the past, following periods of volatility in the overall market and the market price of a company's securities, securities class action litigation has often been instituted against these companies. This litigation, if instituted against us, could result in substantial costs and a diversion of our management's attention and resources. Finally, our executive officers, who may hold a substantial number of shares of our common stock, may from time to time, pledge all or a portion of their holdings as collateral or include such holdings in margin accounts. If our stock price were to drop suddenly, such margin accounts could be called and the shares in such accounts may be automatically sold by a third party in the open market, even during a blackout period.

***We face significant volatility in supply and demand conditions for our products, and this volatility, as well as any failure by us to accurately forecast future supply and demand conditions, could materially and negatively impact our business.***

The semiconductor industry has historically been characterized by wide fluctuations in the demand for, and supply of, semiconductors. Demand for our products depends in large part on the continued growth of various electronics industries that use our products, including, but not limited to:

- wireless telecommunications equipment;
- computers and computer-related peripherals;
- memory products;
- networking equipment and
- consumer electronics, including mobile handsets, tablets, notebook PC's, automotive electronics and industrial controls.

Any downturn or reduction in the growth of these industries could seriously harm our business, financial condition and results of operations. In particular, our TrueTouch™ family of products is highly concentrated in consumer handset markets which are susceptible to changes in the general economy, consumer acceptance, design wins, competition and price.

We order materials and build our products based primarily on our internal forecasts, customer and distributor forecasts and secondarily on existing orders, which may be cancelled under many circumstances. Because our markets can be volatile, are based on consumer demand and subject to rapid technological and price changes, our forecasts may be inaccurate, causing us to make too many or too few of certain products.

Also, our customers frequently place orders requesting product delivery almost immediately after the order is made, which makes forecasting customer demand even more difficult, particularly when supply is abundant. If we experience inadequate demand or a significant shift in the mix of product orders that makes our existing capacity and capability inadequate, our fixed costs per semiconductor produced will increase, which will harm our financial condition and results of operations. Alternatively, if we should experience a sudden increase in

demand, we will need to quickly ramp our inventory and/or manufacturing capacity to adequately respond to our customers. If we or our manufacturing partners are unable to ramp our inventory or manufacturing capacity in a timely manner or at all, we risk losing our customers' business, which could have a negative impact on our financial performance and reputation.

***If we fail to compete successfully in our highly competitive industry and markets, our business, financial condition and results of operations will be seriously harmed.***

The semiconductor industry is intensely competitive. This intense competition results in a difficult operating environment that is marked by erosion of average selling prices over the life of each product and rapid technological change resulting in limited product life cycles. In order to offset selling price decreases, we attempt to decrease the manufacturing costs of our products and to introduce new, higher priced products that incorporate advanced features. If these efforts are not successful or do not occur in a timely manner, or if our newly introduced products do not gain market acceptance, our business, financial condition and results of operations could be seriously harmed.

Our ability to compete successfully in the rapidly evolving semiconductor industry depends on many factors, including:

- our success in developing and marketing new products, software platforms and manufacturing technologies and bringing them to market on a timely basis; especially our new touchscreen products which have been a major source of revenue growth over the last three years;
- the quality and price of our products;
- the diversity of our product lines;
- the cost effectiveness of our design, development, manufacturing, support and marketing efforts, especially as compared to our competitors;
- our success in developing and introducing firmware in a timely manner;
- our customer service and customer satisfaction;
- our ability to successfully execute our flexible manufacturing initiative;
- the pace at which customers incorporate our products into their systems, as is sometimes evidenced by design wins;
- the number, strength and nature of our competitors, the markets they target and the rate and success of their technological advances;
- the success of certain of our development activity which is a part of our Emerging Technologies business segment;
- our ability to get competitive terms with our vendors, manufacturing partners and suppliers;
- general economic conditions; and
- our access to and the availability of working capital.

Although we believe we currently compete effectively in the above areas to the extent they are within our control, given the pace of change in our industry, our current abilities are not guarantees of future success. If we are unable to compete successfully in this environment, our business, financial condition and results of operations will be seriously harmed.

***If we fail to develop, introduce and sell new products or fail to develop and implement new technologies, our ability to compete in our end markets will suffer and our financial results could be adversely impacted.***

Like many semiconductor companies, which operate in a highly competitive, quickly changing environment marked by rapid obsolescence of existing products, our future success depends on our ability to develop and introduce new products that customers choose to buy. Our new products, for example PSoC<sup>®</sup>3 and 5 and TrueTouch<sup>™</sup> and our ETD companies are an important strategic focus for us and therefore, they tend to consume a significant amount of our resources. The new products the market requires tend to be increasingly complex, incorporating more functions and operating at faster speeds than old products. Increasing complexity generally



requires smaller features on a chip. This makes manufacturing new generation of products substantially more difficult than prior generations.

Despite the significant amount of resources we commit to new products, there can be no guarantee that such products will perform as expected or at all, be introduced on time to meet customer schedules or gain market acceptance. If we fail to introduce new product designs or technologies in a timely manner or are unable to manufacture products according to the requirements of these designs, or if our customers do not successfully introduce new systems or products incorporating our products, or market demand for our new products does not materialize as anticipated, our business, financial condition and results of operations could be materially harmed.

***The complex nature of our manufacturing activities, our broad product portfolio, and our increasing reliance on third-party manufacturers makes us highly susceptible to manufacturing problems and these problems can have a substantial negative impact on us if they occur.***

Making semiconductors is a highly complex and precise process, requiring production in a tightly controlled, clean environment. Even very small impurities in our manufacturing materials, defects in the masks used to print circuits on a wafer or other problems in the wafer fabrication process can cause a substantial percentage of wafers to be rejected or numerous chips on each wafer to be non-functional. We and, similarly, our third party foundry partners, may experience problems in achieving an acceptable success rate in the manufacture of wafers and the likelihood of facing such difficulties is higher in connection with the transition to new manufacturing methods. The interruption of wafer fabrication or the failure to achieve acceptable manufacturing yields at any of our facilities, or the facilities of our third-party foundry partners, would seriously harm our business, financial condition and results of operations. We may also experience manufacturing problems in our assembly and test operations and in the introduction of new packaging materials.

***We are increasingly dependent upon third parties to manufacture, distribute, generate a significant portion of our product sales, fulfill our customer orders and transport our product. Problems in the performance or availability of these companies could seriously harm our financial performance.***

Although a majority of our products are fabricated in our manufacturing facilities located in Minnesota and the Philippines, we rely to a significant extent on independent contractors to manufacture and assemble our products. We expect to increase this reliance on third-party manufacturing in the future. In addition, if market demand for our products exceeds our internal manufacturing capacity and available capacity from our foundry partners, we may seek additional foundry manufacturing arrangements.

A shortage in foundry manufacturing capacity, which is more likely to occur at times of increasing demand, could hinder our ability to meet demand for our products and therefore adversely affect our operating results. In addition, greater demand for wafers produced by any such foundries without an offsetting increase in foundry capacity raises the likelihood of potential wafer price increases. Our operations would be disrupted if any of our foundry partners terminates its relationship with us or has financial issues and we are unable to arrange a satisfactory alternative to fulfill customer orders on a timely basis and in a cost-effective manner. There are also only a few foundry vendors that have the capabilities to manufacture our most advanced products. If we engage alternative sources of supply, we may encounter start-up difficulties, yield issues or incur additional costs. Shipments could be delayed significantly while these sources are qualified for volume production.

While a high percentage of our products are assembled, packaged and tested at our manufacturing facility located in the Philippines, we rely on independent subcontractors to assemble, package and test the balance of our products. We cannot be certain that these subcontractors will continue to assemble, package and test products for us on acceptable economic and quality terms or at all and it might be difficult for us to find alternatives if they do not do so.

Our foundry partners and assembly and test subcontractors have operations in locations that may suffer the impact of certain natural disasters, which could impact their ability to provide us with our products. We monitor

these events closely, but if one of our third party manufacturing partners were to suffer significant damage to its operations as a result of a natural disaster, our ability to timely meet consumer demand would suffer which would materially harm our financial results of operation.

Our channel partners include distributors and resellers. We continue to expand and change our relationships with our distributors and expect to see an increase in the proportion of our revenues generated from our distributor channel in the future. Worldwide sales through our distributors accounted for approximately 75% of our net sales in fiscal year 2012. We rely on many distributors to assist us in creating customer demand, providing technical support and other value-added services to our customers, filling customer orders and stocking our products. We face ongoing business risks due to our reliance on our channel partners to create and maintain customer relationships where we have a limited or no direct relationship. Should our relationships with our channel partners or their effectiveness decline, we face the risk of declining demand which could affect our revenue and results of operations. Our contracts with our distributor may be terminated by either party upon notice. In addition, our distributors are located all over the world and are of various sizes and financial conditions. Any disruptions to our distributors' operations such as lower sales, lower earnings, debt downgrades, the inability to access capital markets and higher interest rates could have an adverse impact on our business.

We also rely on independent carriers and freight haulers to move our products between manufacturing plants and our customers' facilities. Transport or delivery problems due to their error or because of unforeseen interruptions in their business due to factors such as strikes, political instability, terrorism, natural disasters or accidents could seriously harm our business, financial condition and results of operations and ultimately impact our relationship with our customers.

***We may be unable to protect our intellectual property rights adequately and may face significant expenses as a result of ongoing or future litigation.***

The protection of our intellectual property rights, as well as those of our subsidiaries, is essential to keeping others from copying the innovations that are critical to our existing and future products. It may be possible for an unauthorized third party to reverse-engineer or decompile our software products. The process of seeking patent protection can be long and expensive and we cannot be certain that any currently pending or future applications will actually result in issued patents, or that, even if patents are issued, they will be respected by third parties. Furthermore, our flexible fab initiative requires us to enter into technology transfer agreements with external partners, providing third party access to our intellectual property and resulting in additional risk. In some cases, these technology transfer and/or license agreements are with foreign companies and subject our intellectual property to foreign countries which may afford less protection and/or result in increased costs to enforce such agreements or intellectual property rights. We anticipate that we will continue to enter into these kinds of licensing arrangements in the future. Consequently, we may become involved in litigation, in the United States or abroad, to enforce our patents or other intellectual property rights, to protect our trade secrets and know-how, to determine the validity or scope of the proprietary rights of others or to defend against claims of invalidity. We are also from time to time involved in litigation relating to alleged infringement by us of others' patents or other intellectual property rights.

Moreover, a key element of our strategy is to enter new markets with our products. If we are successful in entering these new markets, we will likely be subject to additional risks of potential infringement claims against us as our technologies are deployed in new applications and face new competitors. We may be unable to detect the unauthorized use of, or take appropriate steps to enforce, our intellectual property rights, particularly in certain international markets, making misappropriation of our intellectual property more likely. Patent litigation, if necessary or if and when instituted against us, could result in substantial costs and a diversion of our management's attention and resources.

Other companies or entities also have commenced, and may again commence, actions seeking to establish the invalidity of our patents. In the event that one or more of our patents are challenged, a court may invalidate the patent(s) or determine that the patent(s) is not enforceable, which could harm our competitive position. If our

patents are invalidated, or if the scope of the claims in any of these patents is limited by court decision, we could be prevented from licensing the invalidated or limited portion of such patents. Such adverse decisions could negatively impact our revenues.

Intellectual property litigation is frequently expensive to both the winning party and the losing party and could take up significant amounts of management's time and attention. In addition, if we lose such a lawsuit, a court could find that our intellectual property rights are invalid, enabling our competitors to use our technology, or require us to pay substantial damages and/or royalties or prohibit us from using essential technologies. For these and other reasons, this type of litigation could seriously harm our business, financial condition and results of operations. Also, although in certain instances we may seek to obtain a license under a third party's intellectual property rights in order to bring an end to certain claims or actions asserted against us, we may not be able to obtain such a license on reasonable terms or at all. We believe we have meritorious defenses and claims in our current litigation and we intend to defend and pursue such claims vigorously. Unfortunately, such litigation and other claims are subject to inherent uncertainties.

We also rely on trade secret protection for our technology, in part through confidentiality and other written agreements with our employees, consultants and third parties. Through these and other written agreements, we attempt to control access to and distribution of our intellectual property documentation and other proprietary technology information. Despite our efforts to protect our proprietary rights, former employees, consultants or third parties may, in an unauthorized manner, attempt to use, copy or otherwise obtain and market or distribute our intellectual property rights or technology or otherwise develop a product with the same functionality as our technology. Policing unauthorized use of our intellectual property rights is difficult, and nearly impossible on a worldwide basis. Therefore, we cannot be certain that the steps we have taken or will take in the future will prevent misappropriation of our technology or intellectual property rights, particularly in foreign countries where we do business or where our technology is sold or used, where the laws may not protect proprietary rights as fully as do the laws of the United States or where the enforcement of such laws is not common or effective.

***If credit market conditions do not continue to improve or if they worsen, it could have a material adverse impact on our investment portfolio.***

The ongoing U.S. sub-prime mortgage defaults and the global financial, economic and credit issues have had a significant impact across various sectors of the financial markets, causing global credit and liquidity issues. If the global credit market does not continue to improve or if it deteriorates, our investment portfolio may be impacted and we could determine that some of our investments are impaired. This could materially adversely impact our results of operations and financial condition.

***We face additional problems and uncertainties associated with international operations that could seriously harm us.***

International revenues historically accounted for a significant portion of our total revenues. Our manufacturing, assembly, test operations and certain finance operations located in the Philippines, as well as our international sales offices and design centers, face risks frequently associated with foreign operations including but not limited to:

- currency exchange fluctuations;
- the devaluation of local currencies;
- political instability;
- labor issues;
- the impact of natural disasters on local infrastructures and economies;
- changes in local economic conditions;
- import and export controls;
- potential shortage of electric power supply;

- potential violations by our international employees or third party agents of international or U.S. laws relevant to foreign operations (such as FCPA) and
- changes in tax laws, tariffs and freight rates.

To the extent any such risks materialize, our business, financial condition or results of operations could be seriously harmed.

***We compete with others to attract and retain key personnel, and any loss of, or inability to attract, such personnel would harm us.***

To a greater degree than most non-technology companies, we depend on the efforts and abilities of certain key members of management and other technical personnel. Our future success depends, in part, upon our ability to retain such personnel and to attract and retain other highly qualified personnel, particularly product and process engineers. We compete for these individuals with other companies, academic institutions, government entities and other organizations. Competition for such personnel is intense and we may not be successful in hiring or retaining new or existing qualified personnel. Equity awards are critical to our ability to hire and retain such key personnel. In addition, we may also need to significantly increase our cash based compensation to retain such personnel.

***Our financial results could be adversely impacted if our Emerging Technologies businesses fail to develop and successfully bring to market new and proprietary products.***

We have made a financial and personnel commitment to our Emerging Technologies businesses. Despite the significant amount of resources we commit to our Emerging Technologies businesses, there can be no guarantee that such Emerging Technologies businesses will perform as expected or at all, launch new products and solutions as expected or gain market acceptance. If our Emerging Technologies businesses' fail to introduce new product and solutions or successfully develop new technologies, or if our customers do not successfully introduce new systems or products incorporating the products or solutions offered by our Emerging Technologies businesses or market demand for the products or solutions offered by our Emerging Technologies businesses do not materialize as anticipated, our business, financial condition and results of operations could be materially harmed.

***Any guidance that we may provide about our business or expected future results may differ significantly from actual results.***

From time to time we have shared our views in press releases or SEC filings, on public conference calls and in other contexts about current business conditions and our expectations as to potential future results. Correctly identifying the key factors affecting business conditions and predicting future events is inherently an uncertain process especially in these very uncertain economic times. Our analyses and forecasts have in the past and, given the complexity and volatility of our business, will likely in the future, prove to be incorrect and could be materially incorrect. We offer no assurance that such predictions or analyses will ultimately be accurate, and investors should treat any such predictions or analyses with appropriate caution. Any analysis or forecast that we make which ultimately proves to be inaccurate may adversely affect our stock price.

***We are subject to many different environmental, health and safety laws, regulations and directives, and compliance with them may be costly.***

We are subject to many different international, federal, state and local governmental laws and regulations related to, among other things, the storage, use, discharge and disposal of toxic, volatile or otherwise hazardous chemicals used in our manufacturing process, conflict mineral and data privacy legislation, as well as the health and safety regulations related to our employees. Compliance with these regulations can be costly. We cannot assure you that we have been, or will be at all times in complete compliance with such laws and regulations. If we violate or fail to comply with these laws and regulations, we could be fined or otherwise sanctioned by the regulators. Under certain environmental laws, we could be held responsible, without regard to fault, for all of the

costs relating to any contamination at our or our predecessors' past or present facilities and at third party waste disposal sites. We could also be held liable for any and all consequences arising out of human exposure to such substances or other environmental damage.

Over the last several years, there has been increased public awareness of the potentially negative environmental impact of semiconductor manufacturing operations. This attention and other factors may lead to changes in environmental regulations that could force us to purchase additional equipment or comply with other potentially costly requirements. If we fail to control the use of, or to adequately restrict the discharge of, hazardous substances under present or future regulations, we could face substantial liability or suspension of our manufacturing operations, which could seriously harm our business, financial condition and results of operations.

We face increasing complexity in our product design as we adjust to new and future requirements relating to the material composition of our products, including the restrictions on lead and other hazardous substances that apply to specified electronic products put on the market in the European Union (Restriction on the Use of Hazardous Substances Directive 2002/95/EC, also known as the "RoHS Directive") and similar legislation in China and California. Other countries, including at the federal and state levels in the United States, are also considering laws and regulations similar to the RoHS Directive. Certain electronic products that we maintain in inventory may be rendered obsolete if they are not in compliance with the RoHS Directive or similar laws and regulations, which could negatively impact our ability to generate revenue from those products. Our customers and other companies in the supply chain may require us to certify that our products are RoHS compliant. Although we cannot predict the ultimate impact of any such new laws and regulations, they will likely result in additional costs or decreased revenue, and could require that we redesign or change how we manufacture our products.

***Business disruptions could seriously harm our future revenue and financial condition and increase our costs and expenses.***

Our worldwide operations could be adversely affected if disrupted for any reason, including natural disasters such as earthquakes, tsunamis, floods, hurricanes, typhoons, telecommunication or information technology system failures, regulatory or political issues, power or water shortages, fires, extreme weather conditions, medical epidemics or pandemics or other man-made disasters or catastrophic events. While we maintain business interruption insurance for our primary foreign manufacturing operations, we are self-insured for any loss or damage to our primary manufacturing facility. As such, the occurrence of any of these business disruptions for us or our third party manufacturers, partners or customers could result in significant losses, seriously harm our revenue and financial condition, adversely affect our competitive position, increase our costs and expenses, and require substantial expenditures and recovery time in order to fully resume operations. Our corporate headquarters, and a portion of our research and development activities, are located in California, and other critical business operations and some of our suppliers are located in California and Asia, near major earthquake faults known for seismic activity. The manufacture of product components, the final assembly of our products and other critical operations are concentrated in certain geographic locations, including the Philippines, China and India. We also rely on major logistics hubs primarily in Asia to manufacture and distribute our products. The ultimate impact on us, our significant suppliers and our general infrastructure of being located near major earthquake faults and being consolidated in certain geographical areas is unknown. However in the event of a major earthquake or other natural disaster or catastrophic event, our revenue, profitability and financial condition could suffer.

***System security risks, data protection breaches, cyber-attacks and systems integration issues could disrupt our internal operations, and any such disruption could reduce our expected revenue, increase our expenses, damage our reputation and adversely affect our stock price.***

Experienced computer programmers and hackers may be able to penetrate our network security and misappropriate or compromise our confidential and proprietary information, create system disruptions or cause shutdowns. Computer programmers and hackers also may be able to develop and deploy viruses, worms, and

other malicious software programs that attack our products or otherwise exploit any security vulnerabilities of our products. The costs to us to eliminate or alleviate cyber or other security problems, bugs, viruses, worms, malicious software programs and security vulnerabilities could be significant, and our efforts to address these problems may not be successful and could result in interruptions and delays that may impede our sales, manufacturing, distribution or other critical functions.

We manage and store various proprietary information and sensitive or confidential data relating to our business on the cloud. Breaches of our security measures or the accidental loss, inadvertent disclosure or unapproved dissemination of proprietary information or sensitive or confidential data about us, including the potential loss or disclosure of such information or data as a result of fraud, trickery or other forms of deception, could expose us to a risk of loss or misuse of this information, result in litigation and potential liability for us, damage our brand and reputation or otherwise harm our business. In addition, the cost and operational consequences of implementing further data protection measures could be significant.

Portions of our IT infrastructure also may experience interruptions, delays or cessations of service or produce errors in connection with systems integration or migration work that takes place from time to time. We may not be successful in implementing new systems and transitioning data, which could cause business disruptions and be more expensive, time consuming, disruptive and resource-intensive. Such disruptions could adversely impact our ability to fulfill orders and interrupt other processes. Delayed sales, lower margins or lost customers resulting from these disruptions have adversely affected us in the past, and in the future could adversely affect our financial results, stock price and reputation.

***We maintain self-insurance for certain indemnities we have made to our officers and directors, and if a significant payment were to arise out of such liabilities, it could harm our financial condition and results of operation. .***

Our certificate of incorporation, by-laws and indemnification agreements require us to indemnify our officers and directors for certain liabilities that may arise in the course of their service to us. We self-insure with respect to these indemnifiable claims. If we were required to pay a significant amount on account of these liabilities for which we self-insure, our business, financial condition and results of operations could be seriously harmed.

***We utilize debt financing and such indebtedness could adversely affect our business, financial condition, results of operations, earnings per share and our ability to meet our payment obligations.***

We routinely incur indebtedness to finance our operations and from time to time we have significant amounts of outstanding indebtedness and substantial debt service requirements. In June 2012, we entered into a five-year senior secured revolving credit facility for up to \$430 million with a group of lenders led by Morgan Stanley Senior Funding, Inc. The credit facility contains customary affirmative, negative and financial covenants, including a maximum senior secured leverage ratio, a maximum total leverage ratio, minimum fixed charge coverage ratio, and a minimum liquidity of at least \$150 million. Our ability to meet our payment and other obligations and covenants under our indebtedness depends on our ability to generate significant cash flow. This, to some extent, is subject to general economic, financial, competitive, legislative and regulatory factors as well as other factors that are beyond our control. There is no assurance that our business will generate cash flow from operations, or that future borrowings will be available to us under our existing or any amended credit facilities or otherwise, in an amount sufficient to enable us to meet payment obligations under indebtedness we may under take from time to time. If we are not able to generate sufficient cash flow to service our debt obligations, we may need to refinance or restructure our debt, sell assets, reduce or delay capital investments, or seek to raise additional capital. If we are unable to implement one or more of these alternatives, we may not be able to meet our payment obligations under any indebtedness we owe. As of December 30, 2012, our outstanding debt included \$232 million related to our recent credit facility, \$15 million in capital leases, and \$11.5 million in equipment loans. See Note 14 for more information on our Senior Secured Revolving Credit Facility and equipment loans, Note 18 for more information on capital leases and Note 5 for more information on advances received for the sale of auction rate securities.

***New regulations related to “conflict minerals” may force us to incur additional expenses, may make our supply chain more complex and may result in damage to our reputation with customers.***

On August 22, 2012, under the Dodd-Frank Wall Street Reform and Consumer Protection Act of 2010, or the Dodd-Frank Act, the SEC adopted new requirements for companies that use certain minerals and metals, known as conflict minerals, in their products, whether or not these products are manufactured by third parties. These requirements will require companies to diligence, disclose and report whether or not such minerals originate from the Democratic Republic of Congo and adjoining countries. We will have to diligence whether such minerals are used in the manufacture of our products. However, the implementation of these new requirements could adversely affect the sourcing, availability and pricing of such minerals if they are found to be used in the manufacture of our products. In addition, we will incur additional costs to comply with the disclosure requirements, including costs related to determining the source of any of the relevant minerals and metals used in our products. Since our supply chain is complex, we may not be able to sufficiently verify the origins for these minerals and metals used in our products through the due diligence procedures that we implement, which may harm our reputation. In such event, we may also face difficulties in satisfying customers who require that all of the components of our products are certified as conflict mineral free. The first report is due on May 31, 2014 for the 2013 calendar year. However, in October 2012, the U.S. Chamber of Commerce, the National Association of Manufacturers and the Business Roundtable filed a petition challenging the adoption of the rules by the SEC. It is presently unclear if this challenge will delay the effectiveness of the rule.

***Changes in U.S. tax legislation regarding our foreign earnings could materially impact our business.***

A majority of our revenue is generated from customers located outside the U.S. and a substantial portion of our assets, including employees, are located outside the U.S. Foreign withholding taxes and U.S. income taxes have not been provided on undistributed earnings for certain non-U.S. subsidiaries, because such earnings are intended to be indefinitely reinvested in the operations of those subsidiaries. In the past, the administration has considered initiatives which could substantially reduce our ability to defer U.S. taxes including: limitations on deferral of U.S. taxation of foreign earnings eliminate utilization or substantially reduce our ability to claim foreign tax credits, and eliminate various tax deductions until foreign earnings are repatriated to the U.S. If any of these proposals are constituted into law, they could have a negative impact on our financial position and results of operations.

We are subject to examination by the U.S. Internal Revenue Service (the “IRS”), and from time to time we are subject to income tax audits or similar proceedings in other jurisdictions in which we do business, and as a result we may incur additional costs and expenses or owe additional taxes, interest and penalties which will negatively impact our operating result.

We are subject to income taxes in the U.S. and certain foreign jurisdictions, and our determination of our tax liability is subject to review by applicable domestic and foreign tax authorities. The results of these US and certain foreign jurisdiction examinations may result in a decrease of our current estimate of unrecognized tax benefits or increase of actual tax liabilities which could negatively impact our financial position, results of operations and cash flows.

***The accumulation of changes in our shares by “5-percent stockholders” could trigger an ownership change for U.S. income tax purposes, in which case our ability to utilize our net operating losses would be limited and therefore impact our future tax benefits.***

Cypress is a publicly traded company whose stockholders can change on a daily basis. These changes are beyond our control. The U.S. Internal Revenue Code (Section 382) restricts a company’s ability to benefit from net operating losses if a “Section 382 Ownership Change” occurs. An ownership change for purposes of U.S. tax law Section 382 may result from ownership changes that increase the aggregate ownership of “5-percent stockholders,” by more than 50 percentage points over a testing period, generally three years (“Section 382 Ownership Change”). To our knowledge, we have not experienced a Section 382 Ownership Change. We cannot give any assurance that we will not experience a Section 382 Ownership Change in future years.

***Acquisition and investments could result in operating difficulties, dilution, and other harmful consequences that may adversely impact our business and results of operations.***

Acquisitions are an important element of our overall corporate strategy and use of capital. These transactions could be material to our financial condition and results of operations. In addition to the recent acquisition of Ramtron, we also expect to continue to evaluate and enter into discussions regarding a wide array of potential strategic transactions. The process of integrating an acquired company, business, or technology has created, and will continue to create, unforeseen operating difficulties and expenditures. The areas where we face risks include, but are not limited to:

- Diversion of management time and focus from operating our business to integration challenges.
- Cultural challenges associated with integrating employees from the acquired company into our organization, and retention of employees from the businesses we acquire.
- Successfully transitioning the current customer, supplier, foundry and other partnering relationships of the acquired company.
- Implementation or remediation of controls, procedures, and policies at the acquired company.
- Integration of the acquired company's accounting, human resource, and other administrative systems, and coordination of product, engineering, and sales and marketing functions.
- In the case of acquired companies with global operations, the need to integrate operations across different cultures and languages and to address the particular economic, currency, political, and regulatory risks associated with specific countries.
- Failure to successfully further develop the acquired business or technology.
- Liability for activities of the acquired company before the acquisition, including intellectual property infringement claims, violations of laws, commercial disputes, tax liabilities, and other known and unknown liabilities.
- Pending litigation or other known or unknown claims in connection with the acquired company, including claims by stockholders for breach of fiduciary duties, terminated employees, customers, former stockholders, or other third parties.

Our failure to address these risks or other problems encountered in connection with our past or current acquisitions and investments could cause us to fail to realize the anticipated benefits of such acquisitions or investments, incur unanticipated liabilities, and harm our business generally. Our inability to conduct due diligence in advance of a public company acquisition such as the Ramtron transaction increases the risk associated with the integration issues noted above and could result in unanticipated liabilities or financial results that could cause us not to realize the anticipated benefits of such an acquisition.

Current and future acquisitions could also result in dilutive issuances of our equity securities, the incurrence of debt, contingent liabilities, or amortization expenses, or write-offs of goodwill, any of which could harm our financial condition or results. Also, the anticipated benefit of many of our acquisitions may not materialize.

***There can be no assurance that our cash distributions on common stock will continue to be considered a return of capital.***

In the second quarter of fiscal 2011, our Board of Directors adopted a policy pursuant to which the Company would pay quarterly cash distributions on our common stock. We intend to continue to pay such distributions subject to capital availability and periodic determinations by our Board of Directors that cash distributions are in the best interest of our shareholders and are in compliance with all laws and agreements of Cypress applicable to the declaration and payment of cash distributions. Based upon our lack of current earnings and profits, in the United States, these distributions have been treated for income tax purposes as a return of capital.

Future distributions may be affected by, among other factors:

- our views on potential future capital requirements for investments in acquisitions and the funding of our research and development;
- stock repurchase programs;



- changes in federal and state income tax laws or corporate laws; and
- changes to our business model.

Our distribution payments may change from time to time, and we cannot provide assurance that we will continue to declare distributions in any particular amounts or at all. In addition, we cannot provide assurance that the cash distributions will continue to be treated for income tax purposes as a return of capital. A reduction in our distribution payments or a change in the tax treatment of future distributions could have a negative effect on our stock price.

## ITEM 1B. UNRESOLVED STAFF COMMENTS

None.

## ITEM 2. PROPERTIES

Our executive offices are located in San Jose, California. The following tables summarize our primary properties as of the end of fiscal 2012:

Location	Square Footage	Primary Use
<b>Owned:</b>		
<u>United States:</u>		
Bloomington, Minnesota	337,000	Manufacturing, research and development
San Jose, California	171,000	Administrative offices, research and development
Round Rock, Texas	100,000	Property held for sale
Colorado Springs, Colorado	70,400	Administrative offices
Lynnwood, Washington	67,000	Administrative offices, research and development
<u>Asia:</u>		
Cavite, Philippines	221,000	Manufacturing, research and development
<b>Leased:</b>		
<u>Asia:</u>		
Bangalore, India	193,000	Research and development
Shanghai, China	29,000	Research and development

In connection with the acquisition of Ramtron, we acquired a building in Colorado Springs, Colorado, which serves as a design center and administrative office. The building has a testing facility to support research and development, prototype manufacturing, advanced materials development and customer quality assurance and failure analysis support. The building is encumbered.

The manufacturing facility located in Round Rock, Texas ceased operations in fiscal 2008. The net book value of the remaining restructured assets that were classified as held for sale and included in "Other current assets" in the Consolidated Balance Sheets was \$4.6 million as of December 30, 2012 and \$6.9 million as of January 1, 2012 and January 2, 2011. In fiscal 2012, management reassessed the fair value of the assets account due to the continuing unfavorable economic and market conditions. Based on this analysis, we recorded a write-down of \$2.3 million. No impairment was recognized in fiscal 2011 and 2010. We continue to incur expenses related to ongoing maintenance and upkeep of the Texas facility until we complete the sale of the property.

In the fourth quarter of fiscal 2011, we sold a building located in San Jose, California, consisting of 62,688 square feet, to a third party for approximately \$5.1 million. Refer to Note 7 for more information on this transaction.

In April 2011, we sold a building located in San Jose, California consisting of 75,732 square feet to a charitable organization for \$4.0 million in exchange for a promissory note. Refer to Note 18 for more information on this transaction.

We have additional leases for sales offices and design centers located in the United States, Asia and Europe. We believe that our current properties are suitable and adequate for our foreseeable needs. We may need to exit facilities as we continue to evaluate our business model and cost structure.

**ITEM 3. LEGAL PROCEEDINGS**

Information with respect to this item may be found in Note 18 of Notes to Consolidated Financial Statements in Item 8, which is incorporated herein by reference.

**ITEM 4. MINE SAFETY DISCLOSURES**

Not applicable.

## PART II

### ITEM 5. MARKET FOR REGISTRANT'S COMMON EQUITY, RELATED STOCKHOLDER MATTERS AND ISSUER PURCHASES OF EQUITY SECURITIES

#### Market Information, Holders of Common Equity, Dividends and Performance Graph

On November 12, 2009, our common stock was listed on the NASDAQ Global Select Market under the trading symbol "CY." Prior to November 12, 2009, our common stock was listed on the New York Stock Exchange. The following table sets forth the high and low per share prices for our common stock:

	<u>Low</u>	<u>High</u>
Fiscal 2012:		
Fourth quarter	\$ 8.80	\$ 11.24
Third quarter	\$ 10.16	\$ 13.51
Second quarter	\$ 12.14	\$ 15.71
First quarter	\$ 14.90	\$ 18.68
Fiscal 2011:		
Fourth quarter	\$ 13.99	\$ 20.25
Third quarter	\$ 14.87	\$ 23.19
Second quarter	\$ 17.83	\$ 23.17
First quarter	\$ 17.94	\$ 23.38
Fiscal 2010:		
Fourth quarter	\$ 12.39	\$ 18.58
Third quarter	\$ 9.94	\$ 13.14
Second quarter	\$ 10.03	\$ 13.62
First quarter	\$ 10.05	\$ 12.43

As of February 15, 2013, there were approximately 1,426 registered holders of record of our common stock.

#### *Dividends*

During fiscal 2012, we paid total cash dividends of \$63.2 million, consisting of dividends of \$0.09 per share of common stock paid in the first quarter of the fiscal year and dividends of \$0.11 per share of common stock paid in the second, third and fourth quarters of the fiscal year. On November 12, 2012 our Board declared a cash dividend of \$0.11 per share payable to holders of record of our common stock at the close of business day on December 27, 2012. This cash dividend was paid on January 17, 2013 and totaled approximately \$15.8 million.

During the second quarter of fiscal 2011, we initiated our first ever dividend program and our Board of Directors declared cash dividends of \$0.09 per share paid in the third and fourth quarters of fiscal 2011. Total cash dividends paid in fiscal 2011 were approximately \$29.0 million. No cash dividends were declared and paid in fiscal 2010.

The following line graph compares the yearly percentage change in the cumulative total stockholder return on our common stock against the cumulative total return of the Standard and Poor (“S&P”) 500 Index and the S&P Semiconductors Index for the last five fiscal years:

**COMPARISON OF 5 YEAR CUMULATIVE TOTAL RETURN\***  
Among Cypress Semiconductor Corporation, the S&P 500 Index, and the S&P Semiconductors Index

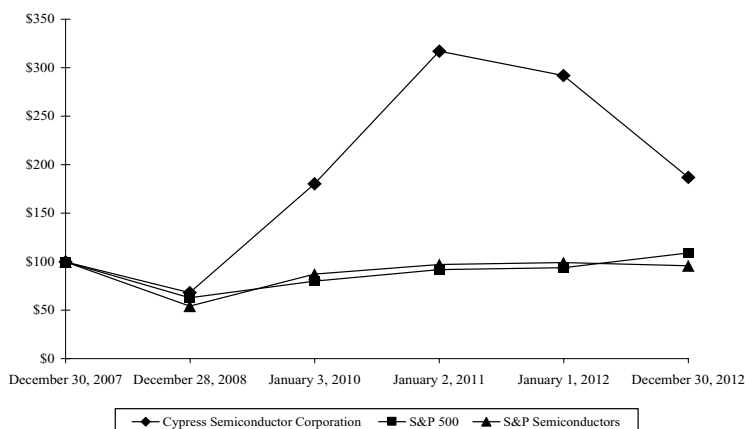

\* \$100 invested on 12/31/07 in stock or index, including reinvestment of dividends. Indexes calculated on month-end basis.

	December 28, 2008	January 3, 2010	January 2, 2011	January 1, 2012	December 30, 2012
Cypress**	\$ 68	\$ 180	\$ 317	\$ 292	\$ 187
S&P 500 Index	\$ 63	\$ 80	\$ 92	\$ 94	\$ 109
S&P Semiconductors Index	\$ 54	\$ 87	\$ 97	\$ 99	\$ 96

\*\* All closing prices underlying this table have been adjusted for cash dividends, stock splits and stock dividends including the SunPower spin.

### Securities Authorized for Issuance under Equity Compensation Plans

#### Equity Compensation Plan Information:

The following table summarizes certain information with respect to our common stock that may be issued under the existing equity compensation plans as of December 30, 2012:

Plan Category	Number of Securities to be Issued Upon Exercise of Outstanding Options	Weighted-Average Exercise Price of Outstanding Options	Number of Securities Remaining Available for Future Issuance Under Equity Compensation Plans (Excluding Securities Reflected in Column (a))
	(a)	(b)	(c)
(In thousands, except per-share amounts)			
Equity compensation plans approved by shareholders	25,200 (1)	\$ 7.67 (3)	19,800 (2)
Equity compensation plans not approved by shareholders	5,400	\$ 5.93	—
Total	30,600	\$ 7.25 (3)	19,800

(1) Includes 7.9 million shares of restricted stock units and restricted stock awards granted.

- (2) Includes 14.8 million shares available for future issuance under Cypress's 1994 Amended Stock Option Plan and 1.2 million under the Assumed Ramtron Plan. In addition, the amount includes 3.7 million shares available for future issuance under Cypress's Employee Stock Purchase Plan.
- (3) Excludes the impact of 7.9 million shares of restricted stock units and restricted stock awards which have no exercise price.

See Note 8 of Notes to Consolidated Financial Statements under Item 8 for further discussion of Cypress's stock plans.

### Recent Sales of Unregistered Securities

None.

### Purchases of Equity Securities by the Issuer and Affiliated Purchasers

#### Stock Buyback Programs:

#### *\$400 Million Program Authorized in Fiscal 2011*

On September 20, 2011, our Board of Directors (the "Board") authorized a new \$400.0 million stock buyback program. The program allows us to purchase our common stock or enter into equity derivative transactions related to our common stock. The timing and actual amount expended with the new authorized funds will depend on a variety of factors including the market price of our common stock, regulatory, legal, and contractual requirements, and other market factors. The program does not obligate us to repurchase any particular amount of common stock and may be modified or suspended at any time at the discretion of our Board.

The table below sets forth information with respect to repurchases of our common stock made during fiscal 2011 and 2012 under this program:

	Total Number of Shares Purchased	Average Price Paid per Share	Total Number of Shares Purchased as Part of Publicly Announced Programs	Total Dollar Value of Shares That May Yet Be Purchased Under the Plans or Programs
	(In thousands, except per-share amounts)			
<b><u>Authorized fund under this</u></b>				
<b><u>Repurchase program:</u></b>	—	\$ —	—	\$ 400,000
<b><u>Repurchases in fiscal 2011:</u></b>				
August 29, 2011—October 2, 2011	1,125	\$ 15.57	1,125	\$ 382,489
October 3, 2011—October 30, 2011	1,257	\$ 14.29	1,257	\$ 364,530
October 31, 2011—November 27, 2011	139	\$ 18.92	139	\$ 361,888
November 28, 2011—January 1, 2012	2,540	\$ 16.42	2,540	\$ 320,189
Total repurchases in fiscal 2011	<u>5,061</u>	\$ 15.77	<u>5,061</u>	\$ 320,189
<b><u>Repurchases in fiscal 2012:</u></b>				
January 2, 2012—April 1, 2012	6,071	\$ 16.15	6,071	\$ 222,160
April 2, 2012—July 1, 2012	1,523	\$ 13.05	1,523	\$ 202,282
July 2, 2012—September 30, 2012	7,285	\$ 11.20	7,285	\$ 120,696
October 1, 2012—December 30, 2012	3,163	\$ 10.22	3,163	\$ 88,381
Total repurchases in fiscal 2012	18,042		18,042	\$ 88,381
Total repurchases under this program	23,103	\$ 13.49	23,103	\$ 88,381

*\$600 Million Program Authorized in Fiscal 2010*

The \$600.0 million stock buyback program authorized by our Board in October 2010 was completed in the third quarter of fiscal 2011. The following table sets forth information with respect to repurchases of our common stock made during fiscal 2011 and 2010 under this program:

	Total Number of Shares Purchased	Average Price Paid per Share	Total Number of Shares Purchased as Part of Publicly Announced Programs	Total Dollar Value of Shares That May Yet Be Purchased Under the Plans or Programs
	(In thousands, except per-share amounts)			
<b>Authorized fund under this</b>				
<b>Repurchase program:</b>	—	\$ —	—	\$ 600,000
<b>Repurchases in fiscal 2010:</b>				
<b>Stock repurchases:</b>				
October 4, 2010—January 2, 2011	<u>1,702</u>	\$ 17.07	<u>1,702</u>	\$ 570,946
Total repurchases in fiscal 2010	<u>1,702</u>	\$ 17.07	<u>1,702</u>	\$ 570,946
<b>Repurchases in fiscal 2011:</b>				
<b>Stock repurchases:</b>				
January 3, 2011—April 4, 2011	5,856	\$ 20.00	5,856	\$ 453,857
April 5, 2011—July 4, 2011	1,317	\$ 19.58	1,317	\$ 427,924
July 5, 2011—October 2, 2011	<u>14,262</u>	\$ 17.35	<u>14,262</u>	\$ 180,635
Total	<u>21,435</u>	\$ 18.21	<u>21,435</u>	\$ 180,635
<b>Yield enhancement structured</b>				
<b>agreements settled in stock:</b>				
January 3, 2011—April 4, 2011	2,500	\$ 20.99	2,500	\$ 128,152
April 5, 2011—July 4, 2011	4,000	\$ 18.84	4,000	\$ 52,802
July 5, 2011—October 2, 2011	<u>3,000</u>	\$ 17.60	<u>3,000</u>	\$ —
Total	<u>9,500</u>	\$ 19.01	<u>9,500</u>	\$ —
Total repurchases in fiscal 2011	<u>30,935</u>	\$ 18.46	<u>30,935</u>	\$ —
Total repurchases under this program	<u>32,637</u>	\$ 18.38	<u>32,637</u>	\$ —

**Yield Enhancement Program (“YEP”):**

In fiscal 2009, the Audit Committee approved a yield enhancement strategy intended to improve the yield on our available cash. As part of this program, the Audit Committee authorized us to enter into short-term yield enhanced structured agreements, typically with maturities of 90 days or less, correlated to our stock price. Under the agreements we have entered into to date, we pay a fixed sum of cash upon execution of an agreement in exchange for the financial institution’s obligations to pay either a pre-determined amount of cash or shares of our common stock depending on the closing market price of our common stock on the expiration date of the agreement. Upon expiration of each agreement, if the closing market price of our common stock is above the pre-determined price, we will have our cash investment returned plus a yield substantially above the yield currently available for short-term cash investments. If the closing market price is at or below the pre-determined price, we will receive the number of shares specified at the agreement’s inception. As the outcome of these arrangements is based entirely on our stock price and does not require us to deliver either shares or cash, other than the original investment, the entire transaction is recorded in equity. The shares received upon the maturing of a yield enhancement structure are included in our “shares of common stock held in treasury” in the Consolidated Balance Sheets under Item 8.

We have entered into various yield enhanced structured agreements based upon a comparison of the yields available in the financial markets for similar maturities against the expected yield to be realized per the structured agreement and the related risks associated with this type of arrangement. We believe the risk associated with these types of agreements is no different than alternative investments available to us with equivalent counterparty credit ratings. All counterparties to a yield enhancement program have a credit rating of at least Aa2 or A as rated by major independent rating agencies. For all such agreements that matured to date, the yields of the structured agreements were far superior to the yields available in the financial markets primarily due to the volatility of our stock price and the pre-payment aspect of the agreements. The counterparty is willing to pay a premium over the yields available in the financial markets due to the structure of the agreement.

The following table summarizes the activity of our settled yield enhanced structured agreements during fiscal 2012, 2011 and 2010:

Periods	Aggregate Price Paid	Total Cash Proceeds Received Upon Maturity	Yield Realized	Total Number of Shares Received Upon Maturity	Average Price Paid per Share
	(In thousands, except per-share amounts)				
<b>Fiscal 2012:</b>					
Settled through cash proceeds	\$ 14,498	\$ 14,931	\$ 433	—	\$ —
Settled through issuance of common stock	—	—	—	—	—
Total for fiscal 2012	\$ 14,498	\$ 14,931	\$ 433	—	\$ —
<b>Fiscal 2011:</b>					
Settled through cash proceeds (1)	\$ 137,798	\$ 143,798	\$ 6,000	—	\$ —
Settled through issuance of common stock (2)	180,636	—	—	9,500	19.01
Total for fiscal 2011	\$ 318,434	\$ 143,798	\$ 6,000	9,500	\$ 19.01
<b>Fiscal 2010:</b>					
Settled through cash proceeds	\$ 207,882	\$ 217,489	\$ 9,607	—	\$ —
Settled through issuance of common stock	114,917	—	—	10,000	11.49
Total for fiscal 2010	\$ 322,799	\$ 217,489	\$ 9,607	10,000	\$ 11.49

(1) This includes a YEP agreement entered into in fiscal 2010 for an aggregate price of approximately \$43.9 million which remained unsettled as of the end of fiscal 2010. Such agreement was subsequently settled in the first quarter of fiscal 2011 for approximately \$47.0 million.

(2) Included as part of the \$600 million stock buyback program authorized in fiscal 2010.

## ITEM 6. SELECTED FINANCIAL DATA

The following selected consolidated financial data is not necessarily indicative of results of future operations, and should be read in conjunction with Management's Discussion and Analysis of Financial Condition and Results of Operations under Item 7, and the Consolidated Financial Statements and Notes to Consolidated Financial Statements under Item 8:

	Year Ended				
	December 30, 2012	January 1, 2012	January 2, 2011	January 3, 2010 (1)(2)(3)	December 28, 2008 (1)(2)(3)
	(In thousands, except per-share amounts)				
<b>Consolidated Statement of Operations Data:</b>					
Revenues	\$ 769,687	\$ 995,204	\$ 877,532	\$ 667,786	\$ 765,716
Cost of revenues	\$ 376,887	\$ 448,602	\$ 388,359	\$ 397,204	\$ 426,284
Operating income (loss)	\$ (18,915)	\$ 153,719	\$ 87,864	\$ (149,255)	\$ (471,433)
Gain on sale of SunPower common stock	\$ —	\$ —	\$ —	\$ —	\$ 192,048
Income (loss) from continuing operations attributable to Cypress	\$ (22,370)	\$ 167,839	\$ 75,742	\$ (150,424)	\$ (319,262)
Income from discontinued operations attributable to Cypress	\$ —	\$ —	\$ —	\$ —	\$ 34,386
Income from discontinued operations—noncontrolling interest, net of taxes	\$ —	\$ —	\$ —	\$ —	\$ 34,154
Noncontrolling interest, net of income taxes	\$ (1,614)	\$ (882)	\$ (866)	\$ (946)	\$ (311)
Net income (loss)	\$ (23,984)	\$ 166,957	\$ 74,876	\$ (151,370)	\$ (251,033)
Adjust for net loss (income) attributable to noncontrolling interest	\$ 1,614	\$ 882	\$ 866	\$ 946	\$ (33,843)
Net income (loss) attributable to Cypress	\$ (22,370)	\$ 167,839	\$ 75,742	\$ (150,424)	\$ (284,876)
Net income (loss) per share—basic:					
Continuing operations attributable to Cypress	\$ (0.15)	\$ 1.02	\$ 0.47	\$ (1.03)	\$ (2.12)
Discontinued operations attributable to Cypress	—	—	—	—	0.23
Net income (loss) per share—basic	\$ (0.15)	\$ 1.02	\$ 0.47	\$ (1.03)	\$ (1.89)
Net income (loss) per share—diluted:					
Continuing operations attributable to Cypress	\$ (0.15)	\$ 0.90	\$ 0.40	\$ (1.03)	\$ (2.12)
Discontinued operations attributable to Cypress	—	—	—	—	0.23
Net income (loss) per share—diluted	\$ (0.15)	\$ 0.90	\$ 0.40	\$ (1.03)	\$ (1.89)
Dividends per share:					
Declared	\$ 0.44	\$ 0.27	\$ —	\$ —	\$ —
Paid	\$ 0.42	\$ 0.18	\$ —	\$ —	\$ —
Shares used in per-share calculation:					
Basic	149,266	164,495	161,114	145,611	150,447
Diluted	149,266	186,895	191,377	145,611	150,447
	<b>As of</b>				
	December 30, 2012	January 1, 2012	January 2, 2011	January 3, 2010	December 28, 2008 (2)
	(In thousands)				
<b>Consolidated Balance Sheet Data:</b>					
Cash, cash equivalents and short-term investments	\$ 117,210	\$ 166,330	\$ 434,261	\$ 299,642	\$ 237,792
Working capital	\$ 20,060	\$ 79,190	\$ 383,369	\$ 279,643	\$ 241,370
Total assets	\$ 831,629	\$ 810,090	\$ 1,072,801	\$ 912,508	\$ 928,732
Debt (4)	\$ 264,942	\$ 45,767	\$ —	\$ —	\$ 27,023
Stockholders' equity	\$ 176,861	\$ 397,842	\$ 702,893	\$ 630,384	\$ 638,427

(1) Our historical consolidated financial statements for fiscal 2008 had been recast to account for SunPower as discontinued operations in those fiscal years. Accordingly, we reflected the results of operations of SunPower prior to the Spin-Off as discontinued operations in the Consolidated Statements of Operations Data. The assets, liabilities and noncontrolling interest related to SunPower were reclassified and reflected as discontinued operations in the Consolidated Balance Sheet Data. The Spin-Off of SunPower was approved and completed in fiscal 2008.

(2) During the third quarter of fiscal year 2009, we identified historically immaterial errors related to the value of our raw material inventory balances located in the Philippines. We assessed the materiality of these errors on prior period financial statements and concluded that the errors were not material to any prior annual or interim periods but the cumulative error would be material in the third quarter of fiscal 2009, if the entire correction was recorded in the third quarter. Accordingly, we revised certain prior year amounts and balances to allow for the correct recording of these transactions. The loss from operations for fiscal 2008 increased by \$1.6 million as a result of the inventory error corrections in those periods. Inventory balances as of the end of fiscal 2008 included adjustments related to the previously mentioned inventory error corrections that decreased the balances by approximately \$7.0 million. The balances of accumulated deficit as of the end of fiscal 2008 was appropriately adjusted for the same amount of inventory correction adjustments.



- (3) Effective January 1, 2009, we adopted the new accounting guidance on convertible debt instruments that have a “net settlement feature,” which means instruments that by their terms may be settled either wholly or partially in cash upon conversion. Under the guidance, the liability and equity components of convertible debt instruments that may be settled wholly or partially in cash upon conversion must be accounted for separately in a manner reflective of our nonconvertible debt borrowing rate. Since our 1.00% Notes and our 1.25% convertible subordinated notes (“1.25% Notes” were issued in 2003 and redeemed in February 2007), had an equity component that could be settled in cash or equity, both debt instruments qualified for this treatment.
- The cumulative effect as of December 29, 2008 (the first day of fiscal 2009) of the change in accounting principle was a decrease to convertible debt of approximately \$1.0 million for the discount on the 1.00% Notes, a decrease to additional paid-in capital of approximately \$43.4 million, a decrease to accumulated deficit of approximately \$44.5 million and an increase to debt issuance cost of approximately \$0.1 million. Our adoption of the new guidance resulted in higher interest and other income of \$144.4 million in fiscal 2008.
- (4) The debt in fiscal year 2012 included \$232.0 million debt related to our revolving credit facility, \$15.0 million capital leases, \$11.5 million equipment loans, \$3.3 million mortgage note related to Ramtron, and \$3.1 million advances received for the sale of certain of our auction rate securities (all balances include both short-term and long-term portions). The debt in fiscal year 2011 included \$15.2 million capital leases, \$14.1 million equipment loans and \$16.4 million advances received for the sale of certain of our auction rate securities (all balances include both short-term and long-term portions). See Note 14 for more information on revolving credit facility, equipment loans and mortgage note, Note 18 for more information on capital leases and Note 5 for more information on advances received for the sale of auction rate securities.

## **ITEM 7. MANAGEMENT’S DISCUSSION AND ANALYSIS OF FINANCIAL CONDITION AND RESULTS OF OPERATIONS**

The Management’s Discussion and Analysis of Financial Condition and Results of Operations contain forward-looking statements within the meaning of Section 27A of the Securities Act of 1933, as amended, and Section 21E of the Securities Exchange Act of 1934, as amended, that involve risks and uncertainties, which are discussed under Item 1A.

### **Adjustments to Previously Announced Preliminary Annual Results**

On January 24, 2013, we issued a press release announcing our preliminary annual results for the year ended December 30, 2012. In the press release, we reported a net loss of \$24.4 million in the Consolidated Statements of Operations for the year ended December 30, 2012. Subsequent to the issuance of our press release, we recorded certain adjustments to our reported results relating to: (1) the Ramtron Acquisition, (2) impairment of investment, and (3) stock-based compensation.

*Ramtron Acquisition:* We recorded additional expenses related to our Ramtron acquisition for updates to estimated fair value of acquired assets and other purchase accounting and acquisition related adjustments.

*Impairment of Investment:* We recorded an additional \$1.2 million expense due to an impairment of an investment in a privately-held company where we did not participate in the follow-on round which diluted the value of our investment.

*Stock-based Compensation:* We recorded a reduction in stock-based compensation of \$1.1 million related to updates to the estimated fair market value of certain share-based awards.

The following table presents a reconciliation of the preliminary net loss and net loss per share announced in our press release on January 24, 2013 to the final results reported in this Annual Report on Form 10-K:

	<b>Year Ended December 30, 2012</b>
	<b>(In thousands, except per- share amounts)</b>
Net loss announced on January 24, 2013	\$(24,356)
Adjustments:	
Ramtron acquisition	2,033
Impairment of investments	(1,180)
Stock-based compensation	1,133
Net loss reported in Annual Report on Form 10-K	<u>\$(22,370)</u>
Net loss per share:	
Basic—announced on January 24, 2013	\$ (0.16)
Basic—reported in Annual Report on Form 10-K	\$ (0.15)
Diluted—announced on January 24, 2013	\$ (0.16)
Diluted—reported in Annual Report on Form 10-K	\$ (0.15)

## **EXECUTIVE SUMMARY**

### **General**

Cypress Semiconductor Corporation (“Cypress”) delivers high-performance, mixed-signal, programmable solutions that provide customers with rapid time-to-market and exceptional system value. Our offerings include the flagship Programmable System-on-Chip (“PSoC®”) families and derivatives such as CapSense touch sensing and TrueTouch™ solutions for touchscreens. We are the world leader in universal serial bus (“USB”) controllers, including the high-performance West Bridge solution that enhances connectivity and performance in multimedia handsets, PCs and tablets. We are also a leader in high-performance memories and programmable timing devices. We serve numerous markets including consumer, mobile handsets, computation, data communications, automotive, industrial and military.

As of the end of fiscal 2012, our organization included the following business segments:

Business Segments	Description
<b>MPD:</b> Memory Products Division	A division that focuses on our four static random access memory (“SRAM”) business units, general-purpose programmable clocks and process technology licensing. Its purpose is to enhance our No. 1 position in SRAMs and invent new and related products.
<b>DCD:</b> Data Communications Division	A division focused solely on USB controllers, WirelessUSB™ and West Bridge® peripheral controllers for handsets, PCs and tablets. Its purpose is to enhance our leading position in USB.
<b>PSD:</b> Programmable Systems Division	A division focusing primarily on our PSoC® and PSoC-based products. This business segment focuses on (1) the PSoC platform family of devices including PSoC 1, PSoC 3 and PSoC 5 and all derivatives, (2) PSoC-based user interface products such as CapSense® touch-sensing and TrueTouch® touchscreen products, (3) PSoC-based module solutions including Trackpad and Ovation™ Optical Navigation Sensors (ONS) and (4) automotive products. PSD is chartered to become No. 1 in CapSense and TrueTouch and is chartered to build the base PSoC franchise.
<b>ETD:</b> Emerging Technologies Division	Our “startup” division, which includes AgigA Tech Inc. and Deca Technologies Inc., all majority-owned subsidiaries of Cypress. ETD also includes our foundry business and other development-stage activities. Note that certain businesses, such as our trackpad business, have “graduated” from ETD as it was reported in 2011 into operating divisions.

## Manufacturing Strategy

Our core manufacturing strategy—“flexible manufacturing”—combines capacity from foundries with output from our internal manufacturing facilities. This initiative is intended to allow us to meet rapid swings in customer demand while lessening the burden of high fixed costs, a capability that is particularly important in high-volume consumer markets that we serve with our leading programmable product portfolio.

Consistent with this strategy, in fiscal 2008 we substantially completed the exit of our manufacturing facility in Texas and transferred production to our more cost-competitive facility in Minnesota and outside foundries. We continued to hold the property for sale as of December 30, 2012.

## RESULTS OF OPERATIONS

### Revenues

	Year Ended		
	December 30, 2012	January 1, 2012	January 2, 2011
	(In thousands)		
Programmable Systems Division	\$ 356,389	\$ 482,895	\$ 280,615
Memory Products Division	330,504	394,832	467,422
Data Communications Division	75,632	112,683	127,020
Emerging Technologies and Other	7,162	4,794	2,475
Total revenues	<u>\$ 769,687</u>	<u>\$ 995,204</u>	<u>\$ 877,532</u>

We sold our image sensors product family in early 2011. The revenue pertaining to our image sensors product family for fiscal 2011 and 2010 included in the Memory Products Division segment in the table above amounted to \$7.6 million and \$31.4 million, respectively. There was no revenue pertaining to our image sensors product family for fiscal 2012. For additional information on the sale of Image Sensors Product Family, refer to Note 3 of Notes to Consolidated Financial Statements under Item 8.

#### Programmable Systems Division:

Revenues from the Programmable Systems Division decreased by \$126.5 million in fiscal 2012, or approximately 26.2% compared to fiscal 2011. The revenue decrease was primarily attributable to a decline in sales of our TrueTouch® touchscreen products and a decline in sales of our PSoC platform family of devices. The decrease in our TrueTouch® revenue was primarily due to a decrease in revenue from our handset and tablet customers and lower average selling prices.

Revenues from the Programmable System Division increased by \$202.3 million in fiscal 2011, or approximately 72.1%, compared to fiscal 2010. The increase was primarily attributable to increases in sales of our PSoC family of products mainly due to higher demand in our capacitive and touchscreen applications in mobile devices. Our PSoC product families, including our touchscreen family, continued to gain new design wins, expanded our customer base and increased market penetration in a variety of end-market applications including mobile handsets, tablet computers, cameras, global positioning system devices “GPS” and other products.

#### Memory Products Division:

Revenues from the Memory Products Division decreased by \$64.3 million in fiscal 2012, or approximately 16.3%, compared to fiscal 2011. The revenue decrease was primarily due to the decrease in sales of our SRAM products driven by decreased demand from wireless and wireline end customers and due to the sale of our image sensor business unit during the first quarter of fiscal 2011 which accounted for \$7.6 million of the decrease in revenue in fiscal 2012 compared to fiscal 2011.

Revenues from the Memory Products Division decreased by \$72.6 million in fiscal 2011, or approximately 15.5%, compared to fiscal 2010. The revenue decrease was primarily due to the decrease in sales of our SRAM products driven by decreased demand from wireless and wireline end customers and due to the sale of our image sensor business unit during the first quarter of fiscal 2011 which accounted for a decrease of \$23.8 million in revenue in fiscal 2011 compared to fiscal 2010.

#### Data Communications Division:

Revenues from the Data Communications Division decreased by \$37.1 million in fiscal 2012, or approximately 32.9%, compared to fiscal 2011. The decrease in revenue was primarily attributable to a decrease in sales of our West Bridge controllers and other USB-related products. .

Revenues from the Data Communications Division decreased by \$14.3 million in fiscal 2011, or approximately 11.3%, compared to fiscal 2010. The decrease in revenue was primarily attributable to a decrease in sales of our WirelessUSB and other USB-related products.

#### Emerging Technologies and Other:

Revenues from Emerging Technologies and Other increased by \$2.4 million in fiscal 2012, or approximately 49.4%, compared to fiscal 2011. The revenue increase was primarily due to the overall increase in demand as certain of our Emerging Technologies begun having initial production ramps.

Revenues from Emerging Technologies and Other increased by \$2.3 million in fiscal 2011, or approximately 93.7%, compared to fiscal 2010. The revenue increase was primarily attributable to an overall increase in demand as certain of our Emerging Technologies divisions, mainly driven by our Optical Finger Navigation products for mobile devices, were beginning initial production ramps.

### Cost of Revenues/Gross Margin

	Year Ended		
	December 30, 2012	January 1, 2012	January 2, 2011
		(In thousands)	
Cost of revenues	\$ 376,887	\$ 448,602	\$ 388,359
Gross margin percentage	51.0%	54.9%	55.7%

Gross margin percentage declined to 51.0% in fiscal 2012 from 54.9% in fiscal 2011 primarily due to (i) \$7.7 million patent license fee recorded in fiscal 2012 related to a Patent License Agreement (See Note 18 of Notes to Consolidated Financial Statements) and (ii) the impact of the negative gross margins of our majority-owned subsidiaries (i.e., Emerging Technologies), particularly Deca Technologies, Inc. which has commenced revenue generating activities in fiscal 2012 as well as lower average selling prices, product mix and lower factory absorption. We incurred \$8.3 million in cost of revenues related to Ramtron.

Gross margin percentage declined slightly to 54.9% in fiscal 2011 from 55.7% in fiscal 2010 primarily due to product mix.

### Research and Development (“R&D”)

	Year Ended		
	December 30, 2012	January 1, 2012	January 2, 2011
		(In thousands)	
R&D expenses	\$ 189,897	\$ 189,970	\$ 176,816
As a percentage of revenues	24.7%	19.1%	20.1%

R&D expenditures decreased by \$0.1 million in fiscal 2012, compared to fiscal 2011. The decrease was primarily attributable to a decrease in direct and indirect labor expenses, particularly variable bonus-related expenses, offset by \$4.1 million in Ramtron related R&D expenses. As a percentage of revenues, R&D expenses were higher in fiscal 2012 driven by the decrease in total revenues in the same period.

R&D expenditures increased by \$13.2 million in fiscal 2011, or approximately 7.4%, compared to fiscal 2010. The increase was primarily attributable to a \$3.5 million increase in labor primarily driven by our new emerging technology division, Deca Technologies, Inc., a \$2.8 million increase in stock-based compensation expense, \$2.4 million increase in manufacturing supplies, approximately \$3.0 million increase in R&D professional engineering services and approximately \$1.5 million net increase in other miscellaneous R&D expenses.

### Selling, General and Administrative (“SG&A”)

	Year Ended		
	December 30, 2012	January 1, 2012	January 2, 2011
		(In thousands)	
SG&A expenses	\$ 211,959	\$ 227,976	\$ 218,490
As a percentage of revenues	27.5%	22.9%	24.9%

SG&A expenses decreased by \$16.0 million in fiscal 2012, or approximately 7.0%, compared to fiscal 2011. The decrease was primarily attributable to \$7.6 million decrease in direct and indirect labor expenses, particularly a \$6.2 million decrease in variable bonus-related expenses, and a \$16.7 million decrease in stock-based compensation due to our low stock price in 2012. These direct and indirect labor costs were partially offset by an increase of \$2.2 million expense primarily related to an increase in the value of our deferred compensation plan. We incurred \$7.2 million in SG&A expenses related to Ramtron.

SG&A expenses increased by \$9.5 million in fiscal 2011, or approximately 4.3%, compared to fiscal 2010. The increase was primarily attributable to a \$5.6 million increase in stock-based compensation expense, which was driven mainly by a higher average stock price, a \$2.0 million impairment charge we recognized in the third quarter of fiscal 2011 related to a building which we sold in the fourth quarter of fiscal 2011, \$1.4 million increase in facilities expenses and a \$0.5 million increase in labor costs.

### **Restructuring**

We recorded restructuring charges of \$4.3 million, \$6.3 million and \$3.0 million during fiscal 2012, 2011 and 2010, respectively. The determination of when we accrue for severance costs, and which accounting standard applies, depends on whether the termination benefits are provided under a one-time benefit arrangement or under an on-going benefit arrangement. The \$4.3 million restructuring costs recognized in fiscal 2012 consisted primarily of personnel costs and was mainly due to the restructuring program announced in fiscal 2011. The \$6.3 million restructuring costs recognized in fiscal 2011 consisted primarily of personnel costs and was mainly due to the restructuring program announced in fiscal 2011. The \$3.0 million restructuring cost recognized in fiscal 2010 was also primarily personnel costs and was due to the restructuring program announced in fiscal 2010. Refer to Note 10 of Notes to Consolidated Financial Statements under Item 8 for more detailed discussions on our restructuring programs for fiscal 2012, 2011 and 2010.

### **Assets Held for Sale**

Our Texas facility ceased operations in the fourth quarter of fiscal 2008. As management has committed to a plan to sell the assets associated with the facility, we have classified the assets as held for sale and recorded the assets at the lower of their carrying amount or estimated fair value less cost to sell. Due to the downturn and uncertainty in the commercial real estate market, we were unable to secure a buyer for the Texas facility. In fiscal 2010, we recorded a write-down of \$1.5 million related to the equipment. No write-down was recognized in fiscal 2011. However, in fiscal 2012, due to the continuing unfavorable economic and market conditions, management reassessed the fair value of the assets and recorded a write-down of \$2.3 million. The net book value of the remaining assets that were classified as held for sale and included in "Other current assets" in the Consolidated Balance Sheet was \$4.6 million as of December 30, 2012 and \$6.9 million as of January 1, 2012 and January 2, 2011. Refer to Note 7 of Notes to Consolidated Financial Statements under Item 8 for more information on our assets held for sale.

### **Divestitures**

On December 19, 2012, we completed the divestiture of our wholly-owned subsidiary Cypress Envirosystems ("Envirosystems") and we received nominal consideration that is dependent upon future performance. Envirosystems was an immaterial part of our ETD segment and as a result of the sale we recorded a loss of \$1.6 million in "(Gain) loss on divestiture," on the Consolidated Statement of Operations.

In fiscal 2011, as part of Cypress's continued efforts to focus on programmable products including our flagship PSoC<sup>®</sup> programmable system-on-chip solutions and our TrueTouch<sup>™</sup> touch-sensing controllers, we divested our image sensors product families and sold them to ON for a total cash consideration of \$34.0 million. In connection with the divestiture, we recorded a gain of \$34.3 million. We transferred approximately

80 employees to ON as part of this divestiture. Refer to Note 3 of Notes to Consolidated Financial Statements under Item 8 for more information on this transaction.

We did not have any divestitures during fiscal 2010.

### Interest and Other Income, Net

The following table summarizes the components of interest and other income, net:

	Year Ended		
	December 30, 2012	January 1, 2012	January 2, 2011
	(In thousands)		
Interest income	\$ 694	\$ 1,466	\$ 2,515
Interest expense	(3,824)	(115)	(19)
Changes in fair value of investments under the deferred compensation plan	3,158	(862)	2,653
Impairment of investments	(3,200)	(800)	—
Foreign currency exchange gains (losses), net	(1,460)	1,124	(2,452)
Gain on sale of equity investments	1,601	—	3,628
Others	286	1,046	(23)
Total interest and other income, net	<u>\$ (2,745)</u>	<u>\$ 1,859</u>	<u>\$ 6,302</u>

### Employee Deferred Compensation Plan

We have a deferred compensation plan, which provides certain key employees, including our executive management, with the ability to defer the receipt of compensation in order to accumulate funds for retirement on a tax-deferred basis. We do not make contributions to the deferred compensation plan and we do not guarantee returns on the investments. Participant deferrals and investment gains and losses remain as our liabilities and the underlying assets are subject to claims of general creditors. In fiscal 2012, 2011 and 2010, we recognized changes in fair value of the assets under the deferred compensation plan in “Interest and other income, net” of approximately \$3.2 million, \$(0.9) million and \$2.7 million, respectively. The increase or decrease in the fair value of the investments relates to the increased or decreased performance of the portfolio on a year over year basis. Refer to Note 16 of Notes to Consolidated Financial Statements under Item 8 for more information about our deferred compensation plan.

### Impairment of Investments

We review our investments periodically for impairment and recognize an impairment loss when the carrying value of an investment exceeds its fair value and the decline in value is considered other-than-temporary. During fiscal 2012, two of our privately-held companies which we are invested in at a carrying value of \$2.4 million, offered additional rounds of financing that we declined to participate in. Based on these new rounds of financing, we determined that our investments were impaired and wrote off the \$2.4 million investment amount. One of these rounds of financing was subsequent to the fiscal year end, see to Note 20 for additional information on this subsequent event. In fiscal 2011, we recognized impairment charges totaling approximately \$0.8 million. The impairment expense recognized in fiscal 2011 was related to the decline in value of our investments in non-marketable equity securities which was considered other-than-temporary. No impairment charges on our investments were recognized in fiscal 2010.

For more information about our investments, refer to Note 5 of Notes to Consolidated Financial Statements under Item 8.

### *Gain on Sale of Investments in Marketable Equity Securities*

In connection with the acquisition of Ramtron, we recognized a gain of \$1.7 million on our initial investment of \$3.4 million. For more information about our acquisition, refer to Note 2 of Notes to Consolidated Financial Statements under Item 8.

During fiscal 2010, we sold our equity investment in one publicly traded company for \$4.7 million and recognized a gain of \$3.6 million in "Interest and other income, net". There were no investments in marketable equity securities that were sold in fiscal 2011.

### **Income Taxes**

Our income tax expense was \$2.3 million for 2012. Our income tax benefit was \$11.4 million in fiscal 2011, and our tax expense was \$19.3 million in fiscal 2010. The tax expense in fiscal 2012 was primarily attributable to income taxes associated with our non-U.S. operation. The tax benefit in fiscal 2011 was primarily attributable to a release of previously accrued taxes of approximately \$22.4 million, partially offset by income taxes associated with our non-U.S. operations. The tax expense in fiscal 2010 was primarily attributable to income taxes associated with our non-U.S. operations.

Our effective tax rate varies from the U.S. statutory rate primarily due to earnings of foreign subsidiaries taxed at different rates and a full valuation allowance on net operating losses incurred in the U.S. The calculation of tax liabilities involves dealing with uncertainties in the application of complex global tax regulations. We regularly assess our tax positions in light of legislative, bilateral tax treaty, regulatory and judicial developments in the many countries in which we and our affiliates do business.

Non-U.S. tax authorities have completed their income tax examinations of our subsidiary in India for fiscal years 2002-2006 and our subsidiary in the Philippines for 2008 and 2009. The proposed adjustments in India have been appealed, and we believe the ultimate outcome of these appeals will not result in a material adjustment to our tax liability. The Philippines examinations for 2008 and 2009 resulted in no material adjustments to our tax liabilities. Income tax examinations of our Philippine subsidiary for the 2010 fiscal year and our India subsidiary for the 2007-2008 fiscal years are in progress. We believe the ultimate outcome of these examinations will not result in a material adjustment to our tax liability.

International revenues account for a significant portion of our total revenues, such that a material portion of our pretax income is earned and taxed outside the U.S. at rates ranging from 0% to 25%. The impact on our provision for income taxes of foreign income being taxed at rates different than the U.S. federal statutory rate was a benefit of approximately \$26.4 million, \$43.6 million, and \$43.4 million in 2012, 2011, and 2010, respectively. The foreign jurisdictions with lower tax rates as compared to the U.S. statutory federal rate that had the most significant impact on our provision for foreign income taxes in the periods presented include the Cayman Islands, China, Ireland, the Philippines, and Switzerland.

### **LIQUIDITY AND CAPITAL RESOURCES**

The following table summarizes our consolidated cash and investments and working capital:

	As of	
	December 30, 2012	January 1, 2012
	(In thousands)	
Cash, cash equivalents and short-term investments	\$ 117,210	\$ 166,330
Working capital	\$ 20,060	\$ 79,190



## Key Components of Cash Flows

	Year Ended		
	December 30, 2012	January 1, 2012	January 2, 2011
	(In thousands)		
Net cash provided by operating activities	\$ 134,997	\$ 283,808	\$ 262,746
Net cash provided by (used in) investing activities	\$ (113,036)	\$ 69,100	\$ (150,734)
Net cash used in financing activities	\$ (58,475)	\$ (516,374)	\$ (92,387)

### Fiscal 2012:

In fiscal 2012, cash and cash equivalents decreased by approximately \$36.5 million primarily due to the \$113.0 million cash used in our investing activities, principally related to the cash paid for the acquisition of Ramtron. (See Note 2 for a detailed discussion of the Ramtron acquisition.) Cash and cash equivalents also decreased due to the \$58.5 million cash used in our financing activities, principally related to our stock buyback program and payment of dividends, which were partially offset by cash received from our revolving credit facility and line of credit. Cash used in our investing and financing activities was partially offset by the cash generated from our operating activities of \$135.0 million.

### *Operating Activities*

In fiscal 2012, net cash provided by operating activities was \$135.0 million compared to \$283.8 million in fiscal 2011. Operating cash flows for fiscal 2012 were primarily due to \$138.3 million in net favorable non-cash adjustments to our net loss including stock-based compensation of \$74.3 million and depreciation and amortization of \$50.8 million, an increase in accounts payable and other liabilities, and a decrease in accounts receivable, partially offset by decreases in deferred income on sales to our distributors.

The significant changes in our working capital, excluding the impact of the Ramtron acquisition, as of December 30, 2012 compared to January 1, 2012 were as follows:

- Accounts receivable decreased by \$23.9 million due to lower revenue.
- Accounts payable and other current and long-term liabilities increased by \$19.4 million due to timing of purchases and payments.
- Deferred margin on sales to distributors decreased by \$19.1 million due to lower distributor shipments.

### *Investing Activities*

In fiscal 2012, net cash used in investing activities was \$113.0 million compared to net cash provided by investing activities of \$69.1 million in fiscal 2011. The cash we used for our investing activities in fiscal 2012 was primarily due to the purchase of investments of \$112.8 million, and \$100.9 million for the acquisition of Ramtron, partially offset by proceeds from the sales or maturities and purchases of available for sale investments of \$139.8 million.

### *Financing Activities*

In fiscal 2012, net cash used in financing activities was \$58.5 million compared to \$516.4 million in fiscal 2011. The cash we used in our financing activities in fiscal 2012 was primarily due to \$209.2 million cash used to repurchase shares of our stock, \$22.6 million related to statutory income tax withholdings paid on vested restricted stock awards in lieu of issuing shares of stock and \$63.2 million dividends paid in fiscal 2012. These amounts were partially offset by \$232.0 million of borrowings under our revolving facility and line of credit, net of the repayment of our previous line of credit.

### Fiscal 2011:

In fiscal 2011, cash and cash equivalents decreased by approximately \$163.5 million primarily due to the \$516.4 million cash used in our financing activities, principally related to our stock buyback programs, partially offset by the cash generated from our operating and investing activities of approximately \$283.8 million and \$69.1 million, respectively.

#### *Operating Activities*

In fiscal 2011, net cash provided by operating activities was \$283.8 million compared to \$262.7 million in fiscal 2010. Operating cash flows for fiscal 2011 were primarily driven by higher net income adjusted for certain non-cash items including stock-based compensation of approximately \$100.8 million, depreciation and amortization of approximately \$53.5 million, and partially offset by changes in our working capital. The significant changes in our working capital as of January 1, 2012 compared to January 2, 2011 were as follows:

- Accounts receivable decreased by \$14.2 million due to better collection efforts and the sale of our image sensors product family in early 2011.
- The cash impact from the decrease in inventories was approximately \$4.3 million which was primarily driven by the increased shipments to our direct customers and distributors.
- Accounts payable decreased by \$6.9 million due to timing of purchases and payments.
- Deferred margin on sales to distributors increased by \$18.8 million due to higher distributor shipments.
- Income taxes payable decreased by \$7.0 million primarily due to payments in fiscal 2011.

#### *Investing Activities*

In fiscal 2011, net cash provided by investing activities was \$69.1 million compared to net cash used in investing activities of \$150.7 million in fiscal 2010. The cash we generated from our investing activities in fiscal 2011 was primarily due to \$110.0 million net proceeds from the sales or maturities and purchases of available for sale investments, \$34.0 million proceeds from the sale of image sensor business unit and \$6.3 million proceeds from sales of certain property and equipment, partially offset by \$80.6 million of property and equipment expenditures.

#### *Financing Activities*

In fiscal 2011, net cash used in financing activities was \$516.4 million compared to \$92.4 million in fiscal 2010. The cash we used in our financing activities in fiscal 2011 was primarily due to \$604.8 million cash used to repurchase shares of our stock and cash used for our yield enhancement structured agreements settling in our stock, \$46.0 million related to statutory income tax withholdings paid on vested restricted stock awards in lieu of issuing shares of stock and \$29.0 million dividends paid in fiscal 2011, partially offset by the net proceeds of \$71.2 million from the issuance of common shares under our employee stock plans, \$49.9 million net cash generated from our yield enhancement structured agreements that were settled in cash and \$42.3 million cash generated from equipment loans and other financing arrangements.

### Fiscal 2010:

In fiscal 2010, cash and cash equivalents increased by approximately \$19.6 million primarily due to the cash generated from our operating and investing of \$262.7 million, partially offset by \$150.7 million and \$92.4 million cash used in our investing and financing activities, respectively.

### *Operating Activities*

Net cash provided by operating activities increased by \$173.4 million in fiscal 2010 compared to fiscal 2009. Operating cash flows in fiscal 2010 were primarily driven by net income of \$74.9 million from operations adjusted for certain non-cash items including depreciation and amortization, stock-based compensation expense, restructuring charges and changes in operating assets and liabilities. The changes in our working capital as of January 2, 2011 compared to January 3, 2010 were as follows:

- Accounts receivable increased by \$30.8 million due to higher distributor shipments.
- Deferred margin on sales to distributors increased by \$55.9 million due to higher distributor shipments.
- The cash impact due to the increase in inventories was approximately \$10.0 million and the increase in inventories was to support higher levels of sales in 2010 and a profile build out of certain products.

### *Investing Activities*

Net cash used in investing activities increased by \$107.6 million in fiscal 2010 compared to fiscal 2009. During fiscal 2010, our investing activities primarily included the \$50.8 million of property and equipment expenditures offset by the purchase of investments of \$103.1 million, net of proceeds from sales or maturities.

### *Financing Activities*

Net cash used in financing activities increased by \$85.0 million in fiscal 2010 compared to fiscal 2009. During fiscal 2010, our financing activities primarily included a net of \$149.2 million used on the yield enhancement structured agreements, \$25.9 million used to repurchase our common shares and partially offset by net proceeds of \$82.8 million from the issuance of common shares under our employee stock plans.

## **Liquidity**

### Stock Repurchase Programs:

On October 21, 2010, our Board authorized a \$600.0 million stock buyback program, which we completed in fiscal 2011. In fiscal 2010, we used approximately \$29.0 million of this program to repurchase a total of approximately 1.7 million shares at an average share price of \$17.07. In fiscal 2011, we used the remaining \$571.0 million to repurchase approximately 30.9 million shares at an average share price of \$18.46.

On September 20, 2011, our Board authorized a new \$400.0 million stock buyback program. The program allows us to purchase our common stock or enter into equity derivative transactions related to our common stock. The timing and actual amount expended with the new authorized funds will depend on a variety of factors including the market price of our common stock, regulatory, legal, and contractual requirements, alternatives uses of cash, availability of on shore cash and other market factors. The program does not obligate us to repurchase any particular amount of common stock and may be modified or suspended at any time at our discretion. From September 2011 through the end of fiscal 2012, we used approximately \$311.6 million from this program to repurchase approximately 23.1 million shares at an average share price of \$13.49. As of December 30, 2012, \$88.4 million remained available for future stock repurchases.

### Yield Enhancement Program ("YEP"):

As discussed in Item 5 above and in Note 14 of the Notes to Consolidated Financial Statements under Item 8, we have entered into yield enhanced structured agreements since fiscal 2009. In fiscal 2012, we entered into short-term yield enhanced structured agreements with maturities of 30 days or less for an aggregate price of approximately \$14.5 million. Upon settlement of these agreements, we received approximately \$14.9 million in cash.

In fiscal 2011, we entered into short-term yield enhanced structured agreements with maturities of 50 days or less for an aggregate price of approximately \$318.4 million. Upon settlement of these agreements, we received approximately \$143.8 million in cash and 9.5 million shares of common stock at an average share price of \$19.01.

In fiscal 2010, we entered into short-term yield enhanced structured agreements with maturities of 45 days or less for an aggregate price of approximately \$322.8 million. Upon settlement of these agreements, we received approximately \$217.5 million in cash and 10.0 million shares of our common stock at an average share price of \$11.49. In fiscal 2010, there was a YEP agreement that we entered into for an aggregate price of approximately \$43.9 million which remained unsettled as of the end of fiscal 2010. Such agreement was subsequently settled in the first quarter of fiscal 2011 for approximately \$47.0 million.

#### Senior Secured Revolving Credit Facility

On June 26, 2012, we entered into a five-year senior secured revolving credit facility (“Credit Facility”) with a group of lenders led by Morgan Stanley Senior Funding, Inc. The Credit Facility enables us to borrow up to \$430 million on a revolving basis. Borrowing terms vary based on the type of borrowing with all outstanding balances being due at the credit facility termination date, or June 25, 2017. Outstanding amounts may be repaid prior to maturity without penalty and are mandatory for certain asset sales and casualty events. The current outstanding borrowings bear interest at LIBOR plus 2.25% on the drawn amount. There is a commitment fee payable of 0.375% per annum on any undrawn amounts. The Credit Facility contains customary affirmative, negative and financial covenants for similarly rated companies. The financial covenants include the following conditions: 1) maximum senior secured leverage ratio of 2.00 to 1.00, 2) maximum total leverage ratio of 3.50 to 1.00 through June 30, 2013 and 3.00 to 1.00 thereafter, 3) minimum fixed charge coverage ratio of 1.20 to 1.00, and 4) minimum liquidity of at least \$150 million. Borrowings are secured by substantially all assets of the company. At December 30, 2012, our outstanding borrowings of \$232 million were recorded as part of long-term liabilities and are presented as “Loan payable” in the Consolidated Balance Sheet. As of December 30, 2012, we were in compliance with all of the financial covenants under the Credit Facility.

Refer to Note 14 of Notes to Consolidated Financial Statements under Item 8 for more information on our senior secured revolving credit facility.

#### Auction Rate Securities (“ARS”):

In December 2011, we entered into a settlement and securities purchase agreement (the “Securities Agreement”) with a certain financial institution. Pursuant to the terms of the Securities Agreement, we agreed to sell to the financial institution certain of our ARS investments with an aggregate par value of approximately \$19.1 million and carrying value of approximately \$17.3 million for an aggregate sale price of approximately \$16.4 million. Under the terms of the Securities Agreement, we have the option to repurchase from the financial institution any of the ARS we sold to them until November 30, 2013 for the amount at which the related ARS were sold plus agreed upon funding costs. Because of our ability to repurchase the ARS from the date of sale through November 30, 2013, we maintain effective control of these ARS. As such, we did not account for the transaction as a sale and recognized the consideration we received as “Advances received for the sale of ARS” under “Other long-term liabilities” in the 2012 and 2011 Consolidated Balance Sheets. We will continue to account for these ARS as if we never sold them until they are called or the expiration of our call option under the Securities Agreement.

During fiscal 2012 ARS with a par value of \$10.0 million were called for redemption at par and ARS with a par value of \$5.0 million were sold at 98.25 of par, which resulted in the reversal of unrealized losses of \$1.3 million. These ARS were included as part of the Securities Agreement noted above.

The fair value of our investments in ARS was approximately \$5.5 million as of December 30, 2012.

Refer to Note 5 of Notes to Consolidated Financial Statements under Item 8 for more information on our auction rate securities.

## Contractual Obligations

The following table summarizes our contractual obligations as of December 30, 2012:

	Payments Due by Years				
	Total	2013	2014 and 2015	2016 and 2017	After 2018
			(In thousands)		
Purchase obligations (1)	\$ 83,061	\$ 75,754	\$ 7,307	\$ —	\$ —
Operating lease commitments	22,581	5,762	9,728	6,352	739
Capital lease commitments	15,990	2,936	5,873	7,181	—
Mortgage note	3,281	3,281	—	—	—
Total contractual obligations	<u>\$ 124,913</u>	<u>\$ 87,733</u>	<u>\$ 22,908</u>	<u>\$ 13,533</u>	<u>\$ 739</u>

(1) Purchase obligations primarily include non-cancelable purchase orders for materials, services, manufacturing equipment, building improvements and supplies in the ordinary course of business. Purchase obligations are defined as enforceable agreements that are legally binding on us and that specify all significant terms, including quantity, price and timing.

As of December 30, 2012, our unrecognized tax benefits were \$31.5 million, which were classified as long-term liabilities. We believe it is possible that we may recognize approximately \$14.0 to \$16.0 million of our existing unrecognized tax benefits within the next twelve months as a result of the lapse of statutes of limitations and the resolution of agreements with domestic and various foreign tax authorities.

## Capital Resources and Financial Condition

Our long-term strategy is to maintain a minimum amount of cash for operational purposes and to invest the remaining amount of our cash in interest-bearing and highly liquid cash equivalents and debt securities and the purchase of our stock through our stock buyback program and payments of regularly scheduled cash dividends. As of December 30, 2012, in addition to \$63.2 million in cash and cash equivalents, we had \$54.0 million invested in short-term investments for a total cash and short-term investment position of \$117.2 million that is available for use in current operations.

As of December 30, 2012, approximately 15% of our cash and cash equivalents and available for sale investments are offshore funds. While these amounts are primarily invested in U.S. dollars, a portion is held in foreign currencies. All offshore balances are exposed to local political, banking, currency control and other risks. In addition, these amounts, if repatriated may be subject to tax and other transfer restrictions.

We believe that liquidity provided by existing cash, cash equivalents and investments and our borrowing arrangements will provide sufficient capital to meet our requirements for at least the next twelve months. However, should prevailing economic conditions, debt covenants constraints, and/or financial, business and other factors beyond our control adversely affect our estimates of our future cash requirements, we could be required to fund our cash requirements by alternative financing. There can be no assurance that additional financing, if needed, would be available on terms acceptable to us or at all. We may choose at any time to raise additional capital or debt to strengthen our financial position, facilitate growth, enter into strategic initiatives including the acquisition of other companies repurchases of shares of stock or payment of dividends and provide us with additional flexibility to take advantage of other business opportunities that arise.

## Non-GAAP Financial Measures

Regulation G, conditions for use of Non-Generally Accepted Accounting Principles (“Non-GAAP”) financial measures, and other SEC regulations define and prescribe the conditions for use of certain

Non-GAAP financial information. To supplement our consolidated financial results presented in accordance with GAAP, we use Non-GAAP financial measures which are adjusted from the most directly comparable GAAP financial measures to exclude certain items, as described below. Management believes that these Non-GAAP financial measures reflect an additional and useful way of viewing aspects of our operations that, when viewed in conjunction with our GAAP results, provide a more comprehensive understanding of the various factors and trends affecting our business and operations. Non-GAAP financial measures used by us include gross margin, research and development expenses, selling, general and administrative expenses, operating income or loss, net income or loss and basic and diluted net income or loss per share.

Our Non-GAAP measures primarily exclude stock-based compensation, acquisition-related charges, impairments to goodwill, gain or losses on divestiture, investment-related gains and losses, discontinued operations, restructuring costs and other special charges and credits.

We use each of these non-GAAP financial measures for internal managerial purposes, when providing our financial results and business outlook to the public, to facilitate period-to-period comparisons and to formulate our formula driven cash bonus plan and any milestone based stock awards. Management believes that these non-GAAP measures provide meaningful supplemental information regarding our operational and financial performance of current and historical results. Management uses these non-GAAP measures for strategic and business decision making, internal budgeting, forecasting and resource allocation processes. In addition, these non-GAAP financial measures facilitate management's internal comparisons to our historical operating results and comparisons to competitors' operating results.

The table below shows our Non-GAAP financial measures:

	Year Ended		
	December 30, 2012	January 1, 2012	January 2, 2011
	(In thousands, except per shares amounts)		
Non-GAAP revenue	\$ 769,687	\$ 995,204	\$ 883,782
Non-GAAP gross margin	426,693	570,456	518,722
Non-GAAP research and development expenses	166,086	165,787	154,312
Non-GAAP selling, general and administrative expenses	163,804	167,746	163,267
Non-GAAP operating income	96,804	236,922	201,142
Non-GAAP net income attributable to Cypress	91,450	237,533	186,314
Non-GAAP diluted net income per share attributable to Cypress	0.55	1.25	0.94

We believe that providing these Non-GAAP financial measures, in addition to the GAAP financial results, are useful to investors because they allow investors to see our results "through the eyes" of management as these Non-GAAP financial measures reflect our internal measurement processes. Management believes that these Non-GAAP financial measures enable investors to better assess changes in each key element of our operating results across different reporting periods on a consistent basis and provides investors with another method for assessing our operating results in a manner that is focused on the performance of our ongoing operations.

**CYPRESS SEMICONDUCTOR CORPORATION**  
**RECONCILIATION OF GAAP FINANCIAL MEASURES TO NON-GAAP FINANCIAL MEASURES**  
(In thousands, except per-share data)  
(Unaudited)

	Year Ended		
	December 30, 2012	January 1, 2012	January 2, 2011
<b>GAAP revenue</b>	\$ 769,687	\$995,204	\$877,532
SRAM legal settlement	—	—	6,250
<b>Non-GAAP revenue</b>	<u>\$ 769,687</u>	<u>\$995,204</u>	<u>\$883,782</u>
<b>GAAP gross margin</b>	\$ 392,800	\$546,602	\$489,173
Stock-based compensation expense	18,519	23,730	22,716
Impairment of assets and others	3,581	235	213
Changes in value of deferred compensation plan (1)	372	(111)	370
Patent license fee	7,100	—	—
Acquisition-related expense	3,545	—	—
Divestiture expenses	776	—	—
SRAM legal settlement	—	—	6,250
<b>Non-GAAP gross margin</b>	<u>\$ 426,693</u>	<u>\$570,456</u>	<u>\$518,722</u>
<b>GAAP research and development expenses</b>	\$ 189,897	\$189,970	\$176,816
Stock-based compensation expense	(19,800)	(24,297)	(21,541)
Non-cash compensation	(433)	—	—
Changes in value of deferred compensation plan (1)	(568)	114	(959)
Divestiture expenses	(307)	—	—
Acquisition-related expense	(2,703)	—	(4)
<b>Non-GAAP research and development expenses</b>	<u>\$ 166,086</u>	<u>\$165,787</u>	<u>\$154,312</u>
<b>GAAP selling, general and administrative expenses</b>	\$ 211,959	\$227,976	\$218,490
Stock-based compensation expense	(36,013)	(52,754)	(47,202)
Non-cash compensation	(500)	—	—
Impairment of assets and others	(173)	(3,811)	(5,295)
Building donation	—	(4,125)	—
Changes in value of deferred compensation plan (1)	(1,710)	460	(1,726)
Acquisition-related expense	(9,095)	—	—
Divestiture expenses	(664)	—	—
SRAM legal settlement	—	—	(1,000)
<b>Non-GAAP selling, general and administrative expenses</b>	<u>\$ 163,804</u>	<u>\$167,746</u>	<u>\$163,267</u>
<b>GAAP operating income (loss)</b>	\$ (18,915)	\$153,719	\$ 87,864
Stock-based compensation expense	74,332	100,781	91,459
Non-cash compensation	933	—	—
Gain (loss) on divestiture and expenses	3,351	(34,291)	—
Restructuring charges	4,258	6,336	2,975
Impairment of assets and others	3,758	4,045	5,511
Building donation	—	4,125	—
Changes in value of deferred compensation plan (1)	2,650	(685)	3,055
Patent license fee	7,100	—	—
SRAM legal settlement	—	—	7,250
Acquisition-related expenses	19,337	2,892	3,028
<b>Non-GAAP operating income</b>	<u>\$ 96,804</u>	<u>\$236,922</u>	<u>\$201,142</u>

(1) Consistent with the current presentation, all prior periods have been recast to reflect changes in deferred compensation plan as a Non-GAAP adjustment.

**CYPRESS SEMICONDUCTOR CORPORATION**  
**RECONCILIATION OF GAAP FINANCIAL MEASURES TO NON-GAAP**  
**FINANCIAL MEASURES**  
(In thousands, except per-share data)  
(Unaudited)

	Year Ended		
	December 30, 2012	January 1, 2012	January 2, 2011
<b>GAAP net income (loss) attributable to Cypress</b>	\$ (22,370)	\$ 167,839	\$ 75,742
Stock-based compensation expense	74,332	100,781	91,459
Non-cash compensation	933	—	—
Gain (loss) on divestiture and expenses	3,351	(34,291)	—
Restructuring charges	4,258	6,336	2,975
Impairment of assets and others	3,758	4,047	5,506
Building donation	—	4,125	—
Changes in value of deferred compensation plan (1)	(507)	177	402
SRAM legal settlement	—	—	7,250
Acquisition-related expenses	19,337	2,892	3,028
Investment-related gains	2,760	—	(3,158)
Patent license fee	7,100	—	—
Tax effects	(1,502)	(14,373)	3,110
<b>Non-GAAP net income (loss) attributable to Cypress</b>	<u>\$ 91,450</u>	<u>\$ 237,533</u>	<u>\$ 186,314</u>
<b>GAAP net income per share attributable to Cypress—diluted</b>	\$ (0.15)	\$ 0.90	\$ 0.40
Stock-based compensation expense	0.45	0.53	0.45
Non-cash compensation	—	—	—
Gain (loss) on divestiture and expenses	0.02	(0.18)	—
Restructuring charges	0.03	0.04	0.01
Impairment of assets and others	0.02	0.02	0.03
Building donation	—	0.02	—
Changes in value of deferred compensation plan	—	—	—
SRAM legal settlement	—	—	0.04
Acquisition-related expense	0.12	0.02	0.01
Investment-related losses (gains)	0.02	—	(0.02)
Patent license	0.04	—	—
Tax effects	(0.01)	(0.08)	0.02
Non-GAAP share count adjustment	0.01	(0.02)	—
<b>Non-GAAP net income per share attributable to Cypress—diluted</b>	<u>\$ 0.55</u>	<u>\$ 1.25</u>	<u>\$ 0.94</u>

(1) Consistent with the current presentation, all prior periods have been recast to reflect changes in deferred compensation plan as a Non-GAAP adjustment.

**CRITICAL ACCOUNTING POLICIES AND ESTIMATES**

The discussion and analysis of our financial condition and results of operations are based upon our consolidated financial statements included in this Annual Report on Form 10-K and the data used to prepare them. Our consolidated financial statements have been prepared in accordance with accounting principles generally accepted in the United States and we are required to make estimates, judgments and assumptions in the course of such preparation. Note 1 of Notes to Consolidated Financial Statements under Item 8 describes the significant accounting policies and methods used in the preparation of the consolidated financial statements. On an ongoing basis, we re-evaluate our judgments and estimates including those related to revenue recognition, allowances for doubtful accounts receivable, inventory valuation, valuation of long-lived assets, goodwill and financial instruments, stock-based compensation, litigation and settlement costs, and income taxes. We base our



estimates and judgments on historical experience, knowledge of current conditions and our beliefs of what could occur in the future considering available information. Actual results may differ from these estimates under different assumptions or conditions. Our critical accounting policies that are affected by significant estimates, assumptions and judgments used in the preparation of our consolidated financial statements are as follows:

#### Revenue Recognition:

We generate revenues by selling products to distributors, various types of manufacturers including original equipment manufacturers (“OEMs”) and electronic manufacturing service providers (“EMSs”). We recognize revenue on sales to OEMs and EMSs provided that persuasive evidence of an arrangement exists, the price is fixed or determinable, title has transferred, collection of resulting receivables is reasonably assured, there are no customer acceptance requirements, and there are no remaining significant obligations.

Sales to certain distributors are made under agreements which provide the distributors with price protection, other allowances and stock rotation under certain circumstances. Given the uncertainties associated with the rights given to these distributors, revenues and costs related to distributor sales are deferred until products are sold by the distributors to the end customers. Revenues are recognized from those distributors when the products have been sold to the end customers. Reported information includes product resale price, quantity and end customer shipment information as well as remaining inventory on hand. At the time of shipment to those distributors, we record a trade receivable for the selling price since there is a legally enforceable right to receive payment, relieve inventory for the value of goods shipped since legal title has passed to the distributors, and defer the related margin as deferred margin on sales to distributors in the Consolidated Balance Sheets. The effects of distributor price adjustments are recorded as a reduction to deferred revenue at the time the distributors sell the products to the end customers.

We record as a reduction to revenues reserves for sales returns, price protection and allowances, based upon historical experience rates and for any specific known customer amounts. We also provide certain distributors and EMSs with volume-pricing discounts, such as rebates and incentives, which are recorded as a reduction to revenues at the time of sale. Historically these volume discounts have not been significant.

Our revenue reporting is highly dependent on receiving pertinent, accurate and timely data from our distributors. Distributors provide us periodic data regarding the product, price, quantity, and end customer when products are resold as well as the quantities of our products they still have in stock. Because the data set is large and complex and because there may be errors in the reported data, we must use estimates and apply judgments to reconcile distributors’ reported inventories to their activities. Actual results could vary materially from those estimates.

#### Allowances for Doubtful Accounts Receivable:

We maintain an allowance for doubtful accounts for losses that we estimate will arise from our customers’ inability to make required payments. We make estimates of the collectability of our accounts receivable by considering factors such as historical bad debt experience, specific customer creditworthiness, the age of the accounts receivable balances and current economic trends that may affect a customer’s ability to pay. If the data we use to calculate the allowance for doubtful accounts does not reflect the future ability to collect outstanding receivables, additional provisions for doubtful accounts may be needed and our results of operations could be materially affected.

#### Valuation of Inventories:

Management periodically reviews the adequacy of our inventory reserves. We record a write-down for our inventories which have become obsolete or are in excess of anticipated demand or net realizable value. We perform a detailed review of inventories each quarter that considers multiple factors including demand forecasts, product life cycle status, product development plans and current sales levels. Inventory reserves are not relieved until the related inventory has been sold or scrapped. Our inventories may be subject to rapid technological obsolescence and are sold in a highly competitive industry. If there were a sudden and significant decrease in

demand for our products, or if there were a higher incidence of inventory obsolescence because of rapidly changing technology and customer requirements, we could be required to record additional write-downs, and our gross margin could be adversely affected.

#### Valuation of Long-Lived Assets:

Our business requires heavy investment in manufacturing facilities and equipment that are technologically advanced but can quickly become significantly under-utilized or rendered obsolete by rapid changes in demand. In addition, we have recorded intangible assets with finite lives related to our acquisitions.

We evaluate our long-lived assets, including property, plant and equipment and purchased intangible assets with finite lives, for impairment whenever events or changes in circumstances indicate that the carrying value of such assets may not be recoverable. Factors considered important that could result in an impairment review include significant underperformance relative to expected historical or projected future operating results, significant changes in the manner of use of the assets or the strategy for our business, significant negative industry or economic trends, and a significant decline in our stock price for a sustained period of time. Impairments are recognized based on the difference between the fair value of the asset and its carrying value, and fair value is generally measured based on discounted cash flow analysis. If there is a significant adverse change in our business in the future, we may be required to record impairment charges on our long-lived assets.

#### Valuation of Goodwill:

Goodwill represents the excess of the purchase price over the fair value of the net tangible and identifiable intangible assets acquired in a business combination. The carrying amount of goodwill at December 30, 2012 was \$64.2 million, \$32.4 million in the Memory Products Division (“MPD”) and \$31.8 million in the Programmable System Division (“PSD”). The goodwill related to MPD was recorded as part of the acquisition of Ramtron in the fourth quarter of fiscal 2012. The goodwill related to PSD was unchanged from the balance at January 1, 2012. MPD and PSD are the only reportable business segments with goodwill.

We assess our goodwill for impairment on an annual basis and, if certain events or circumstances indicate that an impairment loss may have been incurred, on an interim basis. In accordance with ASU 2011-08, Testing Goodwill for Impairment, qualitative factors can be assessed to determine whether it is necessary to perform the current two-step test for goodwill impairment. If an entity believes, as a result of its qualitative assessment, that it is more-likely-than-not that the fair value of a reporting unit is less than its carrying amount, the quantitative impairment test is required. Otherwise, no further testing is required. The fair value of PSD was substantially in excess of its carrying amount based on the quantitative assessment of goodwill that we performed in fiscal 2010. There have been no triggering events or changes in circumstances since that quantitative analysis to indicate that the fair value of PSD would be less than its carrying amount. We performed a qualitative assessment of goodwill in fiscal 2012 and concluded that it was more likely than not that the fair value of MPD and PSD exceeded its carrying amount. In assessing the qualitative factors, we considered the impact of these key factors: (i) change in the industry and competitive environment; (ii) market capitalization; (iii) stock price; and (iv) overall financial performance such as negative or declining cash flows or a decline in actual or planned revenue or earnings compared with actual and projected results of relevant prior periods. Based on the foregoing, the first and second steps of the goodwill impairment test were unnecessary for fiscal 2012 and goodwill was not impaired as of December 30, 2012. No goodwill impairment was recognized in fiscal 2012, 2011 and 2010.

#### Fair Value of Financial Instruments:

Fair value is the price that would be received to sell an asset or paid to transfer a liability in an orderly transaction between market participants at the measurement date. Our financial assets and financial liabilities that require recognition under the guidance generally include available-for-sale investments, employee deferred compensation plan and foreign currency derivatives. The guidance establishes a hierarchy for inputs used in measuring fair value that maximizes the use of observable inputs and minimizes the use of unobservable inputs

by requiring that the observable inputs be used when available. Observable inputs are inputs that market participants would use in pricing the asset or liability developed based on market data obtained from sources independent of us. Unobservable inputs are inputs that reflect our assumptions about the assumptions market participants would use in pricing the asset or liability developed based on the best information available in the circumstances. As such, fair value is a market-based measure considered from the perspective of a market participant who holds the asset or owes the liability rather than an entity-specific measure. The hierarchy is broken down into three levels based on the reliability of inputs as follows:

- Level 1 includes instruments for which quoted prices in active markets for identical assets or liabilities that we have the ability to access. Our financial assets utilizing Level 1 inputs include U.S. treasuries, money market funds, marketable equity securities and our employee deferred compensation plan.
- Level 2 includes instruments for which the valuations are based on quoted prices for similar assets or liabilities, quoted prices in markets that are not active, or other inputs that are observable or can be corroborated by observable data for substantially the full term of the assets or liabilities. Level 2 assets consist of certain marketable debt instruments for which values are determined using inputs that are observable in the market or can be derived principally from or corroborated by observable market data. Our Level 2 instruments include certain U.S. government securities, commercial paper and corporate notes and bonds.
- Level 3 includes instruments for which the valuations are based on inputs that are unobservable and significant to the overall fair value measurement. Financial assets utilizing Level 3 inputs primarily include auction rate securities. We use an income approach valuation model to estimate the exit price of the auction rate securities, which is derived as the weighted-average present value of expected cash flows over various periods of illiquidity, using a risk adjusted discount rate that is based on the credit risk and liquidity risk of the securities.

Availability of observable inputs can vary from instrument to instrument and to the extent that valuation is based on inputs that are less observable or unobservable in the market, the determination of fair value requires more judgment. Accordingly, the degree of judgment exercised by our management in determining fair value is greatest for instruments categorized in Level 3. In certain cases, the inputs used to measure fair value may fall into different levels of the fair value hierarchy. In such cases, for disclosure purposes the level in the fair value hierarchy within which the fair value measurement in its entirety falls is determined based on the lowest level input that is significant to the fair value measurement in its entirety. In regards to our auction rate securities, the income approach valuation model was based on both Level 2 (credit quality and interest rates) and Level 3 inputs. We determined that the Level 3 inputs were the most significant to the overall fair value measurement, particularly the estimates of risk adjusted discount rates and ranges of expected periods of illiquidity.

#### Stock-Based Compensation:

Under the fair value recognition provisions of the guidance, we recognize stock-based compensation net of an estimated forfeiture rate and only recognize compensation cost for those shares expected to vest over the requisite service period of the awards. Determining the appropriate fair value model and calculating the fair value of share-based payment awards require the input of highly subjective assumptions, including measurement of level of achievement of performance milestones, the expected life of the share-based payment awards and stock price volatility. The assumptions used in calculating the fair value of share-based payment awards represent management's best estimates, but these estimates involve inherent uncertainties and the application of management judgment. As a result, if factors change and we use different assumptions, our stock-based compensation expense could be materially different in the future. In addition, we are required to estimate the expected forfeiture rate and only recognize expense for those shares expected to vest. If our actual forfeiture rate is materially different from our estimate, our future stock-based compensation expense could be significantly different from what we have recorded.

#### Accounting for Income Taxes:

Our global operations involve manufacturing, research and development and selling activities. Profits from non-U.S. activities are subject to local country taxes but are not subject to U.S. tax until repatriated to the U.S. If

is our intention to permanently reinvest these earnings outside the U.S. We record a valuation allowance to reduce our deferred tax assets to the amount that is more likely than not to be realized. We consider historical levels of income, expectations and risks associated with estimates of future taxable income and ongoing prudent and feasible tax planning strategies in assessing the need for the valuation allowance. Should we determine that we would be able to realize deferred tax assets in the future in excess of the net recorded amount, we would record an adjustment to the deferred tax asset valuation allowance. This adjustment would increase income in the period such determination is made.

The calculation of tax liabilities involves dealing with uncertainties in the application of complex global tax regulations. We recognize potential liabilities for anticipated tax audit issues in the U.S. and other tax jurisdictions based on our estimate of whether, and the extent to which, additional taxes will be due. If payment of these amounts ultimately proves to be unnecessary, the reversal of the liabilities would result in tax benefits being recognized in the period when we determine the liabilities are no longer necessary. If the estimate of tax liabilities proves to be less than the ultimate tax assessment, a further charge to expense would result.

## **ITEM 7A. QUANTITATIVE AND QUALITATIVE DISCLOSURES ABOUT MARKET RISK**

### **Interest Rate Risks**

Our investment portfolio consists of a variety of financial instruments that exposes us to interest rate risk, including, but not limited to, money market funds, commercial paper and corporate securities. These investments are generally classified as available-for-sale and, consequently, are recorded on our balance sheets at fair market value with their related unrealized gain or loss reflected as a component of accumulated other comprehensive income in stockholders' equity. Due to the relatively short-term nature of our investment portfolio, we do not believe that an immediate 10% increase in interest rates would have a material effect on the fair market value of our portfolio. Since we believe we have the ability to liquidate this portfolio, we do not expect our operating results or cash flows to be materially affected to any significant degree by a sudden change in market interest rates on our investment portfolio.

### **Foreign Currency Exchange Risk**

We operate and sell products in various global markets and purchase capital equipment using foreign currencies but predominantly the U.S. dollar. As a result, we are exposed to risks associated with changes in foreign currency exchange rates. Changes in exchange rates between foreign currencies and the U.S. dollar may adversely affect our operating margins. For example, when foreign currencies appreciate against the U.S. dollar, inventory and expenses denominated in foreign currencies become more expensive. An increase in the value of the U.S. dollar relative to foreign currencies could make our products more expensive for international customers, thus potentially leading to a reduction in demand, and therefore in our sales and profitability. Furthermore, many of our competitors are foreign companies that could benefit from such a currency fluctuation, making it more difficult for us to compete with those companies. We cannot predict the impact of future exchange rate fluctuations on our business and results of operations.

We analyzed our foreign currency exposure, including our hedging strategies, to identify assets and liabilities denominated in other currencies. For those assets and liabilities, we evaluated the effects of a 10% shift in exchange rates between those currencies and the U.S. dollar. We have determined that there would be an immaterial effect on our results of operations from such a shift.

## ITEM 8. FINANCIAL STATEMENTS AND SUPPLEMENTARY DATA

### INDEX TO CONSOLIDATED FINANCIAL STATEMENTS

	<u>Page</u>
Consolidated Balance Sheets	58
Consolidated Statements of Operations	59
Consolidated Statement of Comprehensive Income (Loss)	60
Consolidated Statements of Stockholders' Equity	61
Consolidated Statements of Cash Flows	63
Notes to Consolidated Financial Statements	65
Report of Independent Registered Public Accounting Firm	108
Schedule II—Valuation and Qualifying Accounts	117

**CYPRESS SEMICONDUCTOR CORPORATION**  
**CONSOLIDATED BALANCE SHEETS**

	<u>December 30, 2012</u>	<u>January 1, 2012</u>
	<u>(In thousands, except per-share amounts)</u>	
<b>ASSETS</b>		
Current assets:		
Cash and cash equivalents	\$ 63,203	\$ 99,717
Short-term investments	54,007	66,613
Accounts receivable, net	82,920	103,524
Inventories	127,596	92,304
Other current assets	41,082	43,492
Total current assets	<u>368,808</u>	<u>405,650</u>
Property, plant and equipment, net	274,427	284,979
Goodwill	64,194	31,836
Intangible assets, net	49,216	8,626
Other long-term assets	74,984	78,999
Total assets	<u>\$ 831,629</u>	<u>\$ 810,090</u>
<b>LIABILITIES AND EQUITY</b>		
Current liabilities:		
Accounts payable	\$ 58,704	\$ 52,868
Accrued compensation and employee benefits	38,190	41,679
Deferred margin on sales to distributors	131,192	150,568
Dividends payable	15,847	13,786
Income taxes payable	6,526	4,629
Other current liabilities	98,289	62,930
Total current liabilities	<u>348,748</u>	<u>326,460</u>
Deferred income taxes and other tax liabilities	40,928	38,610
Long-term revolving credit facility	232,000	—
Other long-term liabilities	33,092	47,178
Total liabilities	<u>654,768</u>	<u>412,248</u>
Commitments and contingencies (Note 18)		
Equity:		
Preferred stock, \$.01 par value, 5,000 shares authorized; none issued and outstanding	—	—
Common stock, \$.01 par value, 650,000 and 650,000 shares authorized; 286,903 and 278,812 shares issued; 144,224 and 154,174 shares outstanding at December 30, 2012 and January 1, 2012, respectively	2,868	2,780
Additional paid-in-capital	2,612,579	2,579,348
Accumulated other comprehensive loss	(444)	(1,940)
Accumulated deficit	(348,533)	(326,163)
Stockholders' equity before treasury stock	2,266,470	2,254,025
Less: shares of common stock held in treasury, at cost; 142,679 and 124,638 shares at December 30, 2012 and January 1, 2012, respectively	<u>(2,085,570)</u>	<u>(1,853,758)</u>
Total Cypress stockholders' equity	180,900	400,267
Noncontrolling interest	(4,039)	(2,425)
Total equity	<u>176,861</u>	<u>397,842</u>
Total liabilities and equity	<u>\$ 831,629</u>	<u>\$ 810,090</u>

The accompanying notes are an integral part of these consolidated financial statements.

**CYPRESS SEMICONDUCTOR CORPORATION**  
**CONSOLIDATED STATEMENTS OF OPERATIONS**

	Year Ended		
	December 30, 2012	January 1, 2012	January 2, 2011
	(In thousands, except per-share amounts)		
Revenues	\$ 769,687	\$ 995,204	\$ 877,532
Costs and expenses (credits):			
Cost of revenues	376,887	448,602	388,359
Research and development	189,897	189,970	176,816
Selling, general and administrative	211,959	227,976	218,490
Amortization of acquisition-related intangible assets	3,996	2,892	3,028
Restructuring costs	4,258	6,336	2,975
(Gain) loss on divestiture	1,605	(34,291)	—
Total costs and expenses, net	<u>788,602</u>	<u>841,485</u>	<u>789,668</u>
Operating income (loss)	(18,915)	153,719	87,864
Interest and other income, net	<u>(2,745)</u>	<u>1,859</u>	<u>6,302</u>
Income (loss) before income taxes and noncontrolling interest	(21,660)	155,578	94,166
Income tax provision (benefit)	<u>2,324</u>	<u>(11,379)</u>	<u>19,290</u>
Income (loss), net of taxes	(23,984)	166,957	74,876
Adjust for loss attributable to noncontrolling interest, net of taxes	<u>1,614</u>	<u>882</u>	<u>866</u>
Net income (loss) attributable to Cypress	<u>(22,370)</u>	<u>167,839</u>	<u>75,742</u>
Net income (loss) per share attributable to Cypress:			
Basic	\$ (0.15)	\$ 1.02	\$ 0.47
Diluted	\$ (0.15)	\$ 0.90	\$ 0.40
Cash dividends declared per share	\$ 0.44	\$ 0.27	\$ —
Shares used in net income (loss) per share calculation:			
Basic	149,266	164,495	161,114
Diluted	149,266	186,895	191,377

The accompanying notes are an integral part of these consolidated financial statements.

**CYPRESS SEMICONDUCTOR CORPORATION**  
**CONSOLIDATED STATEMENTS OF COMPREHENSIVE INCOME (LOSS)**

	Year Ended		
	December 30, 2012	January 1, 2012	January 2, 2011
Net income	\$ (23,984)	\$166,957	\$74,876
Other comprehensive income (loss), net of tax:			
Change in net unrealized gains on available-for-sale investments	1,490	1,147	(1,975)
Other	24	698	(3,505)
Other comprehensive income (loss)	1,514	1,845	(5,480)
Comprehensive income (loss)	(22,470)	168,802	69,396
Adjust for net loss attributable to noncontrolling interest	1,614	882	866
Comprehensive income (loss) attributable to Cypress	\$ (20,856)	\$169,684	\$70,262

The accompanying notes are an integral part of these consolidated financial statements.



**CYPRESS SEMICONDUCTOR CORPORATION**  
**CONSOLIDATED STATEMENTS OF STOCKHOLDERS' EQUITY**

	Common Stock Shares	Common Stock Amount	Additional Paid-In Capital	Accumulated Other Comprehensive Income (Loss)	Accumulated Deficit (In thousands)	Treasury Stock Shares	Treasury Stock Amount	Noncontrolling Interest	Total Equity
<b>Balances at January 3, 2010</b>	<b>235,409</b>	<b>\$ 2,354</b>	<b>\$2,247,716</b>	<b>\$ (723)</b>	<b>\$ (569,744)</b>	<b>76,027</b>	<b>\$(1,048,016)</b>	<b>\$ (1,203)</b>	<b>\$ 630,384</b>
Comprehensive income:									
Net income attributable to Cypress	—	—	—	—	75,742	—	—	—	75,742
Net unrealized loss on available-for-sale investments	—	—	—	(1,975)	—	—	—	—	(1,975)
Other	—	—	—	(505)	—	—	—	—	(505)
Issuance of common shares under employee stock plans	23,985	240	96,624	—	—	—	—	—	96,864
Withholding of common shares for tax obligations on vested restricted shares	—	—	—	—	—	1,103	(14,104)	—	(14,104)
Yield enhancement structured agreements, net	—	—	(34,318)	—	—	10,000	(114,917)	—	(149,235)
Repurchases of common shares	—	—	—	—	—	1,511	(25,912)	—	(25,912)
Stock-based compensation	—	—	91,974	—	—	—	—	—	91,974
Noncontrolling interest	—	—	—	—	—	—	—	(340)	(340)
<b>Balances at January 2, 2011</b>	<b>259,394</b>	<b>2,594</b>	<b>2,401,996</b>	<b>(3,203)</b>	<b>(494,002)</b>	<b>88,641</b>	<b>(1,202,949)</b>	<b>(1,543)</b>	<b>702,893</b>
Comprehensive income:									
Net income attributable to Cypress	—	—	—	—	167,839	—	—	—	167,839
Net unrealized gain on available-for-sale investments	—	—	—	1,147	—	—	—	—	1,147
Other	—	—	—	116	—	—	—	—	116
Issuance of common shares under employee stock plans	19,418	186	71,006	—	—	—	—	—	71,192
Withholding of common shares for tax obligations on vested restricted shares	—	—	—	—	—	2,212	(46,033)	—	(46,033)
Yield enhancement structured agreements, net	—	—	49,927	—	—	9,500	(180,636)	—	(130,709)
Repurchases of common shares	—	—	—	—	—	24,285	(424,140)	—	(424,140)
Stock-based compensation	—	—	99,217	—	—	—	—	—	99,217
Dividends	—	—	(42,798)	—	—	—	—	—	(42,798)
Noncontrolling interest	—	—	—	—	—	—	—	(882)	(882)
<b>Balances at January 1, 2012</b>	<b>278,812</b>	<b>\$ 2,780</b>	<b>\$2,579,348</b>	<b>\$ (1,940)</b>	<b>\$ (326,163)</b>	<b>124,638</b>	<b>\$(1,853,758)</b>	<b>\$ (2,425)</b>	<b>\$ 397,842</b>

**CYPRESS SEMICONDUCTOR CORPORATION  
CONSOLIDATED STATEMENTS OF STOCKHOLDERS' EQUITY (CONTINUED)**

	Common Stock	Additional Paid-In Capital	Accumulated Other Comprehensive Income (Loss)	Accumulated Deficit	Treasury Stock	Noncontrolling Interest	Total Equity
	Shares	Amount	Income (Loss)	Deficit	Shares	Amount	Equity
<b>Balances at January 1, 2012</b>	<b>278,812</b>	<b>\$ 2,780</b>	<b>\$ (1,940)</b>	<b>\$ (326,163)</b>	<b>124,638</b>	<b>\$(1,853,758)</b>	<b>\$ 397,842</b>
Comprehensive income:							
Net income attributable to Cypress			—	(22,370)			(22,370)
Net unrealized gain on available-for-sale investments			1,490				1,490
Net realized gain (loss) on translation adjustments			6				6
Issuance of common shares under employee stock plans	8,091	88					23,795
Issuance of options and RSUs in connection with acquisition		1,805					1,805
Withholding of common shares for tax obligations on vested restricted shares							
Yield enhancement structured agreements, net					1,379	(22,625)	(22,625)
Repurchases of common shares							433
Stock-based compensation					16,662	(209,187)	(209,187)
Dividends							72,573
Noncontrolling interest							(65,287)
							(1,614)
<b>Balances at December 30, 2012</b>	<b>286,903</b>	<b>\$ 2,868</b>	<b>\$ (444)</b>	<b>\$ (348,533)</b>	<b>142,679</b>	<b>\$(2,085,570)</b>	<b>\$ 176,861</b>

(In thousands)

The accompanying notes are an integral part of these consolidated financial statements.

**CYPRESS SEMICONDUCTOR CORPORATION**  
**CONSOLIDATED STATEMENTS OF CASH FLOWS**

	Year Ended		
	December 30, 2012	January 1, 2012	January 2, 2011
	(In thousands)		
Cash flows from operating activities:			
Net income (loss)	\$ (23,984)	\$ 166,957	\$ 74,876
Adjustments to reconcile income (loss) to net cash provided by operating activities:			
Stock-based compensation expense	74,332	100,781	91,459
Depreciation and amortization	50,846	53,503	52,528
Loss (gain) on divestiture	1,605	(34,291)	—
Deferred income taxes and other tax liabilities	821	(15,757)	15,033
Restructuring costs	4,258	6,336	5,366
Contribution of asset	—	4,000	—
Loss (gain) on sale or retirement of property and equipment, net	3,192	3,891	(823)
Impairment of assets	—	1,982	4,926
Impairment of investments	2,666	800	—
Gain on sale of equity investments	—	—	(3,628)
Other	540	257	165
Changes in operating assets and liabilities, net of effects of an acquisition and divestiture:			
Accounts receivable	23,878	14,202	(30,767)
Inventories	1,351	4,280	(10,049)
Other current and long-term assets	(4,797)	(14,895)	(11,013)
Accounts payable and other liabilities	19,403	(27,049)	18,797
Deferred margin on sales to distributors	(19,114)	18,811	55,876
Net cash provided by operating activities	<u>134,997</u>	<u>283,808</u>	<u>262,746</u>
Cash flows from investing activities:			
Proceeds from sales or maturities of available-for-sale investments	139,825	218,555	32,523
Purchases of available-for-sale investments	(112,808)	(108,522)	(140,349)
Acquisition of property, plant and equipment	(33,013)	(80,556)	(50,786)
Cash paid for acquisition, net of cash received	(100,889)		
Proceeds from divestiture	—	34,025	—
Proceeds from sales of property and equipment	63	6,324	3,057
Cash paid for other investments	(7,203)	(3,911)	(2,000)
Net employee contributions to deferred compensation plan	989	3,185	2,141
Proceeds from sales of equity investments	—	—	4,680
Net cash provided by (used in) investing activities	<u>(113,036)</u>	<u>69,100</u>	<u>(150,734)</u>

**CYPRESS SEMICONDUCTOR CORPORATION**  
**CONSOLIDATED STATEMENTS OF CASH FLOWS (CONTINUED)**

	Year Ended		
	December 30, 2012	January 1, 2012	January 2, 2011
	(In thousands)		
Cash flows from financing activities:			
Repurchase of common shares	(209,187)	(424,140)	(25,912)
Yield enhancement structured agreements settled in stock	—	(180,636)	(114,917)
Issuance of common shares under employee stock plans	23,795	71,192	96,864
Yield enhancement structured agreements settled in cash, net	433	49,927	9,607
Withholding of common shares for tax obligations on vested restricted shares	(22,625)	(46,033)	(14,104)
Payments of dividends	(63,227)	(29,048)	—
Proceeds from equipment leases and loans	2,073	26,822	—
Repayment of equipment leases and loans	(5,695)	(848)	—
Proceeds from other financing arrangements	—	16,390	—
Borrowings under revolving credit facility and line of credit	282,000	—	—
Financing costs	(2,792)	—	—
Repayment of line of credit loan	(50,000)	—	—
Repayment of other financing agreements	(13,250)	—	—
Unsettled yield enhancement structured agreements	—	—	(43,925)
Net cash used in financing activities	<u>(58,475)</u>	<u>(516,374)</u>	<u>(92,387)</u>
Net increase (decrease) in cash and cash equivalents	(36,514)	(163,466)	19,625
Cash and cash equivalents, beginning of year	99,717	263,183	243,558
Cash and cash equivalents, end of year	<u>\$ 63,203</u>	<u>\$ 99,717</u>	<u>\$ 263,183</u>
<b>Supplemental disclosures:</b>			
Dividends payable	\$ 15,847	\$ 13,786	\$ —
Cash paid for income taxes	\$ 4,644	\$ 3,841	\$ 2,205
Additions to property, plant and equipment under capital lease arrangement	\$ 18,788	\$ 2,925	\$ —

The accompanying notes are an integral part of these consolidated financial statements.

**CYPRESS SEMICONDUCTOR CORPORATION**  
**NOTES TO CONSOLIDATED FINANCIAL STATEMENTS**

**NOTE 1. DESCRIPTION OF BUSINESS AND SUMMARY OF SIGNIFICANT ACCOUNTING POLICIES**

**Description of Business**

Cypress Semiconductor Corporation (“Cypress” or the “Company”) designs, develops, manufactures and markets high-performance, mixed-signal, programmable solutions that provide customers with rapid time-to-market and system value. Our offerings include the PSoC<sup>®</sup> programmable system-on-chip, universal serial bus (“USB”) controllers, general-purpose programmable clocks and memories. We also offer wired and wireless connectivity technologies that enhance connectivity and performance in multimedia handsets. We serve numerous markets including consumer, computation, data communications, automotive, and industrial.

Our operations outside of the United States include our assembly and test plants and a regional headquarters in the Philippines, and sales offices and design centers located in various parts of the world.

**Financial Statement Preparation**

In November 2012, we completed the acquisition of Ramtron, a publicly traded fabless semiconductor company that designs, develops and markets specialized semiconductor memory and integrated semiconductor solutions that are used in several markets for a wide range of applications. We completed a cash tender offer and purchased the remaining 96% of Ramtron’s outstanding common stock, which we did not own already, at a purchase price of \$3.10 per share for a total cash payment of \$100.9 million, equity consideration of \$1.8 million and have incurred acquisition related expenses of \$15.3 million. This \$15.3 million of acquisition related expenses includes legal, banker, severance expense and costs related to the acceleration of terminated employee stock awards. All existing Ramtron equity based incentive plans were terminated upon the completion of the acquisition. The Ramtron acquisition has been accounted for in accordance with the authoritative accounting guidance and the results of Ramtron are included in Cypress’s consolidated financial statements. See Note 2 for additional details related to the acquisition of Ramtron.

The consolidated financial statements are prepared in accordance with accounting principles generally accepted in the United States and include the accounts of Cypress and all of our subsidiaries. Inter-company transactions and balances have been eliminated in consolidation.

**Fiscal Years**

Our fiscal year ends on the Sunday closest to December 31. Fiscal 2012 ended on December 30, 2012, Fiscal 2011 ended on January 1, 2012 and Fiscal 2010 ended on January 2, 2011. Fiscal 2012, 2011 and 2010 each contained 52 weeks.

**Management Estimates**

The preparation of consolidated financial statements in conformity with accounting principles generally accepted in the United States requires management to make estimates and assumptions that affect the amounts reported in the consolidated financial statements and accompanying notes. Significant estimates and assumptions used in these consolidated financial statements primarily include those related to revenue recognition, inventory valuation, valuation of goodwill and intangible assets, valuation of investments, valuation of stock-based payment awards, allowances for doubtful accounts, warranty reserves, restructuring costs, certain other accrued liabilities and tax valuation allowances. Actual results could differ from those estimates. To the extent there are material differences between the estimates and actual results, our future results of operations will be impacted.

## **Fair Value of Financial Instruments**

For certain of our financial instruments, including cash equivalents, accounts receivable, accounts payable and other current liabilities, the carrying amounts approximate their fair value due to the relatively short maturity of these items. Generally, our certificates of deposit are carried at cost which approximates fair value based on current interest rates. Investments in available-for-sale securities are carried at fair value. See Note 5 for a detailed discussion of our fair value measurements.

## **Cash and Cash Equivalents**

Highly liquid investments with original or remaining maturities of ninety days or less at the date of purchase are considered cash equivalents.

## **Investments**

All of our investments in debt securities and equity securities in publicly traded companies are classified as available-for-sale securities. Available-for-sale debt securities with maturities greater than twelve months are classified as short-term when they are intended for use in current operations. Investments in available-for-sale securities are reported at fair value with unrealized gains and losses, net of tax, as a component of “Accumulated other comprehensive income (loss)” in the Consolidated Balance Sheets. Generally, our certificates of deposit are non-tradable and are carried at cost. We also have equity investments in privately-held companies. These investments are generally carried at cost as these investments do not generally permit us to exert significant influence or control and are included in “Other assets” in the Consolidated Balance Sheets. None of our equity investments are a variable interest entity.

We monitor our investments for impairment periodically and record appropriate reductions in carrying values when the declines are determined to be other-than-temporary. See Note 5 for a detailed discussion of the impairment losses recorded on our investments.

## **Inventories**

Inventories are stated at the lower of standard cost (which approximates actual cost on a first-in, first-out basis) or market. Market is based on estimated net realizable value. We write down our inventories which have become obsolete or are in excess of anticipated demand or net realizable value based upon assumptions about demand forecasts, product life cycle status, product development plans and current sales levels. Inventory reserves are not relieved until the related inventory has been sold or scrapped.

## **Long-Lived Assets**

Property, plant and equipment are stated at cost, less accumulated depreciation. Depreciation is computed for financial reporting purposes using the straight-line method over the estimated useful lives of the assets. Leasehold improvements and leasehold interests are amortized over the shorter of the estimated useful lives of the assets or the remaining term of the lease. Estimated useful lives are as follows:

Equipment	3 to 10 years
Buildings and leasehold improvements	5 to 20 years
Furniture and fixtures	3 to 7 years

We evaluate our long-lived assets, including property, plant and equipment and intangible assets with finite lives, for impairment whenever events or changes in circumstances indicate that the carrying value of such assets may not be recoverable. Factors considered important that could result in an impairment review include significant underperformance relative to expected historical or projected future operating results, significant changes in the manner of use of assets, significant negative industry or economic trends, and a significant decline in our stock price for a sustained period of time. Impairment is recognized based on the difference between the estimated fair value of the asset and its carrying value. Estimated fair value is generally measured based on quoted market prices, if available, appraisals or discounted cash flow analyses.

## **Change in Accounting Estimate**

Due to our recent and future significant investments in our manufacturing equipment coupled with the current developments in our over-all manufacturing process and technologies, we reevaluated and reassessed the reasonableness of the useful lives of our manufacturing equipment during the fourth quarter of fiscal 2011. As a result of our comprehensive study and analysis, we have determined that the useful lives of our manufacturing equipment were longer than historically estimated. The key reasons that prompted us to perform a reevaluation of the useful lives of our manufacturing equipment were: (i) we determined that the average age of most of our existing equipment is more than 10 years; (ii) the recent and future significant investments in certain of our equipment where the risk of technological obsolescence has been determined to be low; and (iii) the expansion of our manufacturing facility which has allowed us to be more competitive and cost effective by reducing operating costs and integrating certain technologies into programmable technology which reduces the risk of technological obsolescence. Accordingly, we revised the useful lives of the related equipment and production assets from 7 years to 10 years beginning in the fourth quarter of fiscal 2011. The revised useful lives of the equipment did not have any impact in the consolidated statement of operations for fiscal 2011 as the decrease in depreciation expense for the fourth quarter of fiscal 2011 was capitalized in inventories. The fiscal 2012 depreciation expense was decreased by approximately \$16.0 million in fiscal 2012 and this amount will decrease over time as the related manufacturing equipment becomes fully depreciated or increase as we acquire more manufacturing equipment.

## **Goodwill and Intangible Assets**

Goodwill and intangible assets with indefinite lives are not amortized but are tested for impairment on an annual basis or whenever events or changes in circumstances indicate that the carrying amount of these assets may not be recoverable. Purchased intangible assets with finite useful lives are amortized using the straight-line method over their estimated useful lives and are reviewed for impairment as discussed above. See Note 4 for more information.

## **Revenue Recognition**

We generate revenues by selling products to distributors, various types of manufacturers including original equipment manufacturers (“OEMs”) and electronic manufacturing service providers (“EMSs”). We recognize revenues on sales to OEMs and EMSs upon shipment provided that persuasive evidence of an arrangement exists, the price is fixed or determinable, title has transferred, collection of resulting receivables is reasonably assured, there are no customer acceptance requirements, and there are no significant remaining obligations.

Sales to certain distributors are made under agreements which provide the distributors with price protection, stock rotation and other allowances under certain circumstances. Given the uncertainties associated with the rights given to these distributors, revenues and costs related to distributor sales are deferred until products are sold by the distributors to the end customers. Revenues are recognized upon receiving notification from the distributors that products have been sold to the end customers. Reported information includes product resale price, quantity and end customer shipment information as well as remaining inventory on hand. At the time of shipment to distributors, we record a trade receivable for the selling price since there is a legally enforceable right to receive payment, relieve inventory for the value of goods shipped since legal title has passed to the distributors, and defer the related margin as deferred income on sales to distributors in the Consolidated Balance Sheets. The effects of distributor price adjustments are recorded as a reduction to deferred income at the time the distributors sell the products to the end customers.

We record as a reduction to revenues reserves for sales returns, price protection and allowances based upon historical experience rates and for any specific known customer amounts. We also provide certain distributors and EMSs with volume-pricing discounts, such as rebates and incentives, which are recorded as a reduction to revenues at the time of sale. Historically these volume discounts have not been significant.

## **Shipping and Handling Costs**

We record costs related to shipping and handling in cost of revenues.

## **Advertising Costs**

Advertising costs consist of development and placement costs of our advertising campaigns and are charged to expense when incurred. Advertising expense was approximately \$4.9 million, \$5.0 million and \$4.0 million for fiscal 2012, 2011 and 2010, respectively.

## **Foreign Currency Transactions**

We use the United States dollar predominately as the functional currency for most of our foreign entities. Assets and liabilities of these entities are remeasured into the United States dollar using exchange rates in effect at the end of the period, except for non-monetary assets and liabilities, such as property, plant and equipment, which are remeasured using historical exchange rates. Revenues and expenses are remeasured using average exchange rates in effect for the period, except for items related to assets and liabilities, such as depreciation, that are remeasured using historical exchange rates. The total gains (losses) for fiscal 2012, 2011 and 2010 was \$1.5 million, \$1.2 million and (\$2.5) million, respectively. The resulting gains and losses from foreign currency remeasurement are included in "Interest and other income, net" in the Consolidated Statements of Operations. For additional details related to items included in "Interest and other income, net," see Note 13.

## **Concentration of Credit Risk**

Financial instruments that potentially subject us to concentrations of credit risk are primarily cash equivalents, debt investments and trade accounts receivable. Our investment policy requires cash investments to be placed with high-credit quality institutions and limits the amount of credit risk from any one issuer. We perform ongoing credit evaluations of our customers' financial condition whenever deemed necessary and generally do not require collateral. We maintain an allowance for doubtful accounts based upon the expected collectability of all accounts receivable.

Outstanding accounts receivable from three of our distributors, accounted for 12.2%, 11.9% and 10.2%, respectively, of our consolidated accounts receivable as of December 30, 2012. Outstanding accounts receivable from three of our distributors, accounted for 14.1%, 13.9% and 11.1%, respectively, of our consolidated accounts receivable as of January 1, 2012.

Revenue generated through three of our distributors, accounted for 13.5%, 12.4% and 10.1% respectively, of our consolidated revenue for fiscal 2012. One end customer, purchases our products from certain of our distributors. Shipments to this end customer accounted for 10.8% of our consolidated revenue for fiscal 2012.

Revenue generated through two of our distributors accounted for 12.8% and 11.2%, respectively, of our consolidated revenue for fiscal 2011. Shipments to one end customer accounted for 10.0% of our consolidated revenue for fiscal 2011.

Revenue generated through two of our distributors accounted for 15% and 10%, respectively, of our consolidated revenue for fiscal 2010. We had no end customers accounting for 10% or greater of our consolidated revenue for fiscal 2010.

## **Income Taxes**

The provision for income taxes is determined using the asset and liability approach of accounting for income taxes. Under this approach, deferred taxes represent the future tax consequences expected to occur when the reported amounts of assets and liabilities are recovered or paid. The provision for income taxes represents



income taxes paid or payable for the current year plus the change in deferred taxes during the year. Deferred taxes result from differences between the financial and tax basis of our assets and liabilities and are adjusted for changes in tax rates and tax laws when changes are enacted. Valuation allowances are recorded to reduce deferred tax assets when management cannot conclude that it is more likely than not that a tax benefit will be realized.

The calculation of tax liabilities involves dealing with uncertainties in the application of complex global tax regulations. We recognize potential liabilities for anticipated tax audit issues in the United States and other tax jurisdictions based on our estimate of whether, and the extent to which, additional taxes will be due. If payment of these amounts ultimately proves to be unnecessary, the reversal of the liabilities would result in tax benefits being recognized in the period when we determine the liabilities are no longer necessary. If the estimate of tax liabilities proves to be less than the ultimate assessment, a further charge to expense would result

### **Recent Accounting Pronouncements**

In February 2013, the Financial Accounting Standards Board (“FASB”) issued an Accounting Standards Update (“ASU”) to the guidance on Comprehensive Income, to improve the reporting of reclassifications out of accumulated other income. This guidance requires entities to provide information about the amounts reclassified out of accumulated other income by component. The authoritative guidance also requires an entity to present, either on the face of the statement where net income is presented or in the notes, significant amounts reclassified out of accumulated other comprehensive income by the respective line items of net income only if the amount reclassified is required under U.S. GAAP to be reclassified to net income in its entirety in the same reporting period. For amounts not required to be reclassified under U.S. GAAP, entities are required to cross-reference to other disclosures required under U.S. GAAP that provide additional detail about those amounts. This guidance is effective for our interim and annual periods beginning after December 15, 2012. We do not believe that the implementation of this authoritative guidance will have any impact on our financial position or results of operations as it affects presentation of components of accumulated other income.

In September 2011, the Financial Accounting Standards Board (“FASB”) issued an ASU to the guidance on Intangibles—Goodwill and Other—Testing Goodwill for Impairment, to simplify how entities test goodwill for impairment. This guidance allows entities to first assess qualitative factors to determine whether it is more likely than not that the fair value of a reporting unit is less than its carrying amount. If a greater than 50 percent likelihood exists that the fair value is less than the carrying amount, then a two-step goodwill impairment test as described in the guidance must be performed. We adopted this guidance in fiscal 2011 and our adoption did not have a significant impact on our consolidated financial statements. See Note 4 for more information.

In June 2011, the FASB issued authoritative guidance on the presentation of comprehensive income to require an entity to present the total of comprehensive income, the components of net income, and the components of other comprehensive income either in a single continuous statement of comprehensive income or in two separate but consecutive statements. The authoritative guidance also required presentation of adjustments for items that are reclassified from other comprehensive income in the statement where the components of net income and the components of other comprehensive income are presented, which was indefinitely deferred by the FASB in December 2011. We adopted this guidance in fiscal 2012 and we now present consolidated statements of comprehensive income (loss) in a separate statement following the consolidated statement of operations. The implementation of this authoritative guidance did not have any impact on our financial position or results of operations as it only required separate presentation of total comprehensive income (loss).

In May 2011, the FASB issued a new standard amending U.S. generally accepted accounting principles (“GAAP”) fair value measurements and disclosures for the purpose of ensuring that fair value measurement and disclosure requirements are the same across both U.S. GAAP and International Financial Reporting Standards (“IFRS”). The standard contains amendments changing the wording used to describe many of the requirements in U.S. GAAP for measuring fair value and for disclosing information about fair value measurements, clarifying the application of existing fair value measurement requirements and changing a particular principle for measuring

fair value or for disclosing information about fair value measurements. This guidance is effective for our interim and annual periods beginning January 2, 2012. Additionally, the standard expands certain disclosure requirements, including qualitative disclosures selected to level 3 fair value measurements. We adopted this authoritative guidance in the fiscal 2012 and our implementation of this authoritative guidance did not have any impact on our financial position or results of operations as it only required additional disclosures related to fair value measurements.

## NOTE 2. BUSINESS COMBINATIONS

### Ramtron International Corporation (“Ramtron”)

In November 2012, we completed the acquisition of Ramtron, a publicly traded fabless semiconductor company that designs, develops and markets specialized semiconductor memory and integrated semiconductor solutions that are used in several markets for a wide range of applications. We had previously owned 4% of Ramtron’s outstanding common stock and in November 2012, we completed a cash tender offer and purchased the remaining 96% of Ramtron’s outstanding common stock at a purchase price of \$3.10 per share for a total cash payment of \$100.9 million, equity consideration of \$1.8 million and have incurred acquisition related expenses of \$15.3 million. This \$15.3 million of acquisition related expenses includes legal, banker, severance expenses and costs related to the acceleration of terminated employee stock awards.

The fair value of the assets acquired and liabilities assumed were recorded in our consolidated balance sheet as of the acquisition date. The results of operations of Ramtron were included in our consolidated results of operations subsequent to the acquisition date. Ramtron is included in our Memory Products Division.

#### Purchase Price Allocation:

The total purchase price paid for the 100% equity interest has been allocated to the net identifiable assets based on the estimated fair value at the acquisition date. We engaged a third party to assist with the determination of the fair value of certain identifiable intangible assets. In determining the value of these assets, management made various estimates and assumptions. These assumptions include but are not limited to the net present value of future expected cash flow from the sale of products. The fair value of all other assets and liabilities acquired was determined based on estimated future benefits or legal obligations associated with the respective asset or liability. The excess of the purchase price over the net identifiable assets and liabilities has been recorded as goodwill on the Consolidated Balance as of December 30, 2012.

The allocation of the purchase consideration is as follows, (in thousands):

#### Purchase price:

Cash	\$ 100,888
Issuance of options and RSUs in connection with acquisition	1,805
Fair value of previously held 4% equity interest	<u>5,170</u>
Total purchase price	<u>\$ 107,863</u>

#### Purchase price allocation:

Net tangible assets	\$ 29,855
Acquired identifiable intangible assets:	
Purchased technology	42,100
Customer relationships	3,000
Trade name and backlog	550
Goodwill	<u>32,358</u>
Total purchase consideration	<u>\$ 107,863</u>

### Remeasurement of Previously Held 4% of Equity Interest in Ramtron

In connection with the acquisition of Ramtron, the difference between the \$3.4 million carrying value and \$5.2 million fair value of the previously held 4% interest was recorded as a non-cash gain on investment in “Interest and other income, net” on the Consolidated Statement of Operations.

	(In thousands)
Fair value of previously held 4% equity interest	\$ 5,170
Carrying value of previously held 4% equity interest	<u>(3,425)</u>
Total gain on investment	<u>\$ 1,745</u>

### *Net Tangible Assets:*

Net tangible assets consist of the following:

	(In thousands)
Accounts receivable, net	\$ 3,829
Inventories	40,153
Fixed assets	3,462
Other	<u>6,699</u>
Total assets acquired	<u>54,143</u>
Accounts payable	3,515
Accrued expenses, liabilities and notes payable	<u>20,773</u>
Total liabilities assumed	<u>24,288</u>
Total net tangible assets	<u>\$ 29,855</u>

### *Acquired Identifiable Intangible Assets:*

The following table presents certain information on the acquired identifiable assets:

<u>Intangible Assets</u>	<u>Method of Valuation</u>	<u>Discount Rate Used</u>	<u>Estimated Useful Lives</u>
Purchased technology	Income Approach	19%-20%	7 –10 years
Customer relationships	Income Approach	19%	10 years
Trade name and backlog	Income Approach	16%-18%	0.75 –1 years

### *Customer Relationships:*

Customer relationships represent the fair value of projected cash flows that will be derived from the sale of products to Ramtron’s existing customers based on existing, in-process, and future versions of the underlying technology.

### *Goodwill:*

Ramtron’s F-RAM offers a unique set of features and combines the best of RAM and ROM into a single package that outperforms other nonvolatile memories with remarkably fast writes, high endurance and ultra-low power consumption. Ramtron’s F-RAM technology complements our nvSRAM business and strengthens our overall memory portfolio. The acquisition will provide synergy with other of our offerings, including USB controllers and our PSoC line, expanding the scope of solutions that we provide. These factors primarily contributed to a purchase price that resulted in goodwill.

Unaudited Pro Forma Financial Information:

The following unaudited pro forma financial information presents the combined results of operations of Cypress and Ramtron as if the acquisition had occurred as of the beginning of fiscal 2011:

	Year Ended	
	December 30, 2012	January 1, 2012
	(In thousands)	
Revenues	\$ 810,143	\$ 1,061,612
Income (loss) from continuing operations	\$ (30,775)	\$ 148,749

The unaudited pro forma financial information should not be taken as representative of our future consolidated results of operations or financial condition.

Conversion of Ramtron Shares

As part of the acquisition of Ramtron, we issued to Ramtron employees options to purchase 328,885 shares of our common stock, 39,432 restricted stock units (“RSUs”) and 148,242 restricted stock awards with an aggregate value of approximately \$2.7 million, in exchange for their options to purchase shares, restricted stock units, and restricted stock awards of Ramtron. Of this amount, \$1.8 million was earned prior to the acquisition date, and therefore, was part of the acquisition consideration. The remaining compensation expense of \$0.9 million will be recognized on an accelerated basis over an average remaining vesting period of two years, subject to adjustment based on estimated forfeitures.

**NOTE 3. DIVESTITURES**

On December 19, 2012, we completed the divestiture of our wholly-owned subsidiary Cypress EnviroSystems (“EnviroSystems”) and we received nominal consideration that is dependent upon future performance. EnviroSystems was part of our ETD segment and as a result of the sale we recorded a loss of \$1.6 million in “(Gain) loss on divestiture,” on the Consolidated Statement of Operations. Prior to the divestiture, EnviroSystems was immaterial to the financial position and operations of Cypress, therefore, the sale did not qualify as a discontinued operation.

As part of our continued efforts to focus on programmable products including our flagship PSoC® programmable system-on-chip solutions and our TrueTouch™ touch-sensing controllers, we divested our image sensors product families, part of our MPD segment, and sold them to ON Semiconductor Corporation (“ON”) on February 27, 2011.

<u>Product Families</u>	<u>Reportable Segment</u>	<u>Buyer</u>	<u>Total Consideration</u>
The image sensors product families	Memory Products Division	ON Semiconductor	\$34.3 million

In connection with the divestiture, we recorded a gain of \$34.3 million. We received \$14.9 million in cash in March of 2011 and received the remaining \$19.1 million in April 2011. The following table summarizes the components of the gain:

	<u>Image Sensors</u> <u>(In thousands)</u>
Cash proceeds	<u>\$ 34,025</u>
Assets sold:	
Inventories	(3,617)
Prepaid and other assets	(2,003)
Property, plant and equipment	(1,178)
Liabilities disposed of:	
Accounts payable	1,508
Other liabilities	3,416
Taxes payable	1,129
Customer advances	1,239
Transaction and other costs	<u>(228)</u>
Gain on divestiture	<u>\$ 34,291</u>

In connection with the divestiture of the image sensor product families, we transferred approximately 80 employees to ON. In addition, we had a transition service agreement (“TSA”) with ON where we acted as an agent and provided certain services related to shipping, manufacturing, planning and general administrative functions including the billing and collection of shipments to ON customers and payments to vendors for manufacturing activities. During the third quarter of fiscal 2011, the services that we provided under the TSA ended per the terms of the agreement.

We did not have any divestitures in fiscal 2010.

#### **NOTE 4. GOODWILL AND INTANGIBLE ASSETS**

##### **Goodwill**

Goodwill represents the excess of the purchase price over the fair value of the net tangible and identifiable intangible assets acquired in a business combination. The carrying amount of goodwill at December 30, 2012 was \$64.2 million, \$32.4 million in the Memory Products Division (“MPD”) and \$31.8 million in the Programmable System Division (“PSD”). The carrying amount of goodwill at January 1, 2012 was \$31.8 million in the Programmable System Division (“PSD”). The goodwill related to MPD was recognized as part of the acquisition of Ramtron in the fourth quarter of fiscal 2012. The goodwill related to PSD was unchanged from the balance at January 1, 2012. MPD and PSD are the only reportable business segments with goodwill.

We assess our goodwill for impairment on an annual basis and, if certain events or circumstances indicate that an impairment loss may have been incurred, on an interim basis. Goodwill impairment exists when the implied fair value of goodwill is less than its carrying value.

In September 2011, the FASB issued ASU 2011-08 -*Testing Goodwill for Impairment* (ASC Topic 350) that was intended to reduce the complexity and costs by allowing an entity the option to make a qualitative evaluation about the likelihood of goodwill impairment to determine whether it should calculate the fair value of a reporting unit. The issuance of ASU 2011-08 provides an entity the option to first assess qualitative factors to determine whether it is necessary to perform the current two-step test for goodwill impairment. If an entity believes, as a result of its qualitative assessment, that it is more-likely-than-not that the fair value of a reporting unit is less than its carrying amount, the quantitative impairment test is required. Otherwise, no further testing is required. We adopted ASU 2011-08 in fiscal 2011. The fair value of PSD was substantially in excess of its carrying amount

based on the latest quantitative assessment of goodwill that we performed in fiscal 2010. There have been no triggering events or changes in circumstances since that quantitative analysis to indicate that the fair value of PSD would be less than its carrying amount.

We performed a qualitative assessment of goodwill at the end of the third fiscal quarter and concluded that it was more likely than not that the fair value of PSD exceeded its carrying amount. In assessing the qualitative factors, we considered the impact of these key factors: (i) change in the industry and competitive environment; (ii) market capitalization; (iii) stock price; and (iv) overall financial performance such as negative or declining cash flows or a decline in actual or planned revenue or earnings compared with actual and projected results of relevant prior periods. Based on the foregoing, the first and second steps of the goodwill impairment test were unnecessary for fiscal 2012 and goodwill was not impaired for PSD as of December 30, 2012. No goodwill impairment was recognized in fiscal 2011 or 2010.

As part of our purchase price accounting performed during the acquisition of Ramtron and subsequent to the acquisition, the goodwill related to MPD was reviewed and no impairment was recognized subsequent to the acquisition date.

### Intangible Assets

The following tables present details of our total intangible assets:

	As of December 30, 2012			As of January 1, 2012		
	Gross	Accumulated Amortization	Net	Gross	Accumulated Amortization	Net
	(In thousands)					
Acquisition-related intangible assets	\$ 151,773	\$ (103,840)	\$ 47,933	\$ 95,134	\$ (88,782)	\$ 6,352
Non-acquisition related intangible assets	10,048	(8,765)	1,283	10,648	(8,374)	2,274
Total intangible assets	<u>\$ 161,821</u>	<u>\$ (112,605)</u>	<u>\$ 49,216</u>	<u>\$ 105,782</u>	<u>\$ (97,156)</u>	<u>\$ 8,626</u>

As of December 30, 2012, the estimated future amortization expense of intangible assets was as follows:

(In thousands)	
2013	\$12,044
2014	8,423
2015 and future	<u>28,749</u>
Total future amortization expense	<u>\$49,216</u>

## NOTE 5. FAIR VALUE MEASUREMENTS

### Assets/Liabilities Measured at Fair Value on a Recurring Basis

The following table presents our fair value hierarchy for our financial assets and liabilities measured at fair value on a recurring basis as of December 30, 2012 and January 1, 2012:

	As of December 30, 2012				As of January 1, 2012			
	Level 1	Level 2	Level 3	Total	Level 1	Level 2	Level 3	Total
	(In thousands)							
<b>Financial Assets</b>								
Reported as cash equivalents:								
Money market funds	\$ 24,187	\$ —	\$ —	\$ 24,187	\$ 77,952	\$ —	\$ —	\$ 77,952
Corporate notes and bonds	—	—	—	—	—	1,340	—	1,340
Total cash equivalents	<u>24,187</u>	<u>—</u>	<u>—</u>	<u>24,187</u>	<u>77,952</u>	<u>1,340</u>	<u>—</u>	<u>79,292</u>
Reported as short-term investments:								
U.S. treasuries	10,032	—	—	10,032	10,072	—	—	10,072
Corporate notes and bonds	—	28,435	—	28,435	—	33,028	—	33,028
Federal agency	—	3,005	—	3,005	—	15,524	—	15,524
Commercial paper	—	11,694	—	11,694	—	7,189	—	7,189
Certificates of deposit	—	840	—	840	—	800	—	800
Asset-held-for-sale	—	4,630	—	4,630	—	6,913	—	6,913
Total short-term investments	<u>10,032</u>	<u>48,604</u>	<u>—</u>	<u>58,636</u>	<u>10,072</u>	<u>63,454</u>	<u>—</u>	<u>73,526</u>
Reported as long-term investments:								
Auction rate securities	—	—	5,504	5,504	—	—	19,004	19,004
Marketable equity securities	1,054	—	—	1,054	3,013	—	—	3,013
Total long-term investments	<u>1,054</u>	<u>—</u>	<u>5,504</u>	<u>6,558</u>	<u>3,013</u>	<u>—</u>	<u>19,004</u>	<u>22,017</u>
Employee deferred compensation plan assets:								
Cash equivalents	3,588	—	—	3,588	1,960	—	—	1,960
Mutual funds	21,207	—	—	21,207	18,046	—	—	18,046
Equity securities	5,322	—	—	5,322	5,448	—	—	5,448
Fixed income	3,732	—	—	3,732	3,799	—	—	3,799
Money market funds	3,293	—	—	3,293	3,723	—	—	3,723
Total employee deferred compensation plan assets	<u>37,142</u>	<u>—</u>	<u>—</u>	<u>37,142</u>	<u>32,976</u>	<u>—</u>	<u>—</u>	<u>32,976</u>
Total financial assets	<u>\$ 72,415</u>	<u>\$ 48,604</u>	<u>\$ 5,504</u>	<u>\$ 126,523</u>	<u>\$ 124,013</u>	<u>\$ 64,794</u>	<u>\$ 19,004</u>	<u>\$ 207,811</u>
<b>Financial Liabilities</b>								
Employee deferred compensation plan liability								
	<u>\$ —</u>	<u>\$ 36,244</u>	<u>\$ —</u>	<u>\$ 36,244</u>	<u>\$ —</u>	<u>\$ 32,485</u>	<u>\$ —</u>	<u>\$ 32,485</u>

### Valuation Techniques:

- Level 1—includes instruments for which quoted prices in active markets for identical assets or liabilities that we have the ability to access. Our financial assets utilizing Level 1 inputs include U.S. treasuries, money market funds, marketable equity securities and our employee deferred compensation plan assets.

- Level 2—includes instruments for which the valuations are based on quoted prices for similar assets or liabilities, quoted prices in markets that are not active, or other inputs that are observable or can be corroborated by observable data for substantially the full term of the assets or liabilities. Level 2 assets consist of certain marketable debt instruments for which values are determined using inputs that are observable in the market or can be derived principally from or corroborated by observable market data. Our Level 2 instruments include certain U.S. government securities, commercial paper, corporate notes and bonds and our employee deferred compensation plan liabilities.
- Level 3—includes instruments for which the valuations are based on inputs that are unobservable and significant to the overall fair value measurement. Financial assets utilizing Level 3 inputs primarily include auction rate securities. We use an income approach valuation model to estimate the exit price of the auction rate securities, which is derived as the weighted-average present value of expected cash flows over various periods of illiquidity, using a risk adjusted discount rate that is based on the credit risk and liquidity risk of the securities.

#### *Auction Rate Securities*

All of our auction rate securities (“ARS”) are classified as Level 3 financial instruments. Our investments in ARS have contractual maturities generally between 20 and 30 years and are usually found in the form of municipal bonds, preferred stock, and a pool of student loans or collateralized debt obligations with interest rates resetting every seven to 49 days through an auction process. The ARS held by us are backed by student loans originated under the Federal Family Education Loan Program, which are guaranteed by the U.S. Federal Department of Education. All the auction rate securities held by us were rated as either AAA, Aaa or A3 by the major independent rating agencies.

#### *Sale of Auction Rate Securities*

In December 2011, we entered into a settlement and securities purchase agreement (the “Securities Agreement”) with a certain financial institution. Pursuant to the terms of the Securities Agreement, we agreed to sell to the financial institution certain of our ARS investments with an aggregate par value of approximately \$19.1 million and carrying value of approximately \$17.3 million for an aggregate sale price of approximately \$16.4 million. Under the terms of the Securities Agreement, we have the option to repurchase from the financial institution any of the ARS we sold to them until November 30, 2013 for the amount at which the related ARS were sold plus agreed upon funding costs. Because of our ability to repurchase the ARS from the date of sale through November 30, 2013, we maintain effective control of these ARS. As such, we did not account for the transaction as a sale and recognized the sale consideration we received as “Advances received for the sale of ARS” under “Other long-term liabilities” in the 2011 Consolidated Balance Sheets. We will continue to account for these ARS as a financing arrangement until they are called or the expiration of our call option under the Securities Agreement.

During fiscal 2012, ARS with a par value of \$10.0 million were called for redemption at par and ARS with a par value of \$5.0 million were sold at 98.25% of par, which resulted in the reversal of unrealized losses of \$1.3 million. These ARS were included as part of the Securities Agreement noted above.

The fair value of our investments in ARS was approximately \$5.5 million and \$19.0 million as of December 30, 2012 and January 1, 2012, respectively.



In fiscal 2012 and 2011, we performed an analysis to assess the fair value of the ARS using a valuation model based on discounted cash flows. The assumptions used were the following:

	<u>2012</u>	<u>2011</u>
Years to liquidity	7 years	7 years
Discount rates *	0.90% – 3.42%	1.75% – 3.95%
Continued receipt of contractual interest which provides a premium spread for failed auctions	Yes	Yes

\* *Discount rates incorporate a spread for both credit and liquidity risk.*

Based on these assumptions, we estimated that the remaining ARS were valued at approximately 93.3%, representing a decline in par value of approximately \$0.4 million as of December 30, 2012. In fiscal 2011, we estimated that the ARS were valued at approximately 91% of their stated par value as of January 1, 2012, representing a decline in par value of approximately \$1.9 million. These losses were recorded as an unrealized loss in “Accumulated other comprehensive loss” in fiscal 2012 and 2011, respectively.

### **Level 3 Investments Measured Fair Value on a Recurring Basis**

The following table presents a summary of changes in our Level 3 investments measured at fair value on a recurring basis:

	<u>Auction Rate Securities</u> (In thousands)
Balance as of January 2, 2011	\$ 23,708
Unrealized gain recorded in Accumulated other comprehensive loss	696
Realized loss recorded in interest and other income, net	(75)
Amounts settled	<u>(5,325)</u>
Balance as of January 1, 2012	19,004
Unrealized gain recorded in Accumulated other comprehensive loss	1,500
Realized loss recorded in interest and other income, net	(112)
Amounts settled / sold	<u>(14,888)</u>
Balance as of December 30, 2012	<u>\$ 5,504</u>

### **Level 3 Assets Measured at Fair Value on a Nonrecurring Basis**

Certain of our assets, including intangible assets, goodwill and cost-method investments, are measured at fair value on a nonrecurring basis if impairment is indicated.

As of December 30, 2012, the carrying value of the Company’s line of credit and mortgage note was \$232.0 million and \$3.3 million, respectively. The fair value of the Company’s line of credit and mortgage notes approximate their fair value since they bear interest rates that are similar to existing market rates.

### *Investments in Equity Securities*

The following table presents a summary of changes in our Level 3 investments measured at fair value on a recurring basis:

	<u>Non-marketable Equity Securities</u> (In thousands)
Balance as of January 2, 2011	\$ 4,000
Write-down of non-marketable equity securities	(800)
Balance as of January 1, 2012	3,200
Write-down of non-marketable equity securities	(3,200)
Balance as of December 30, 2012	<u>\$ —</u>

Our total investments in equity securities included long-term investments in non-marketable equity securities (investments in privately-held companies) of approximately \$6.0 million and marketable equity securities (investments in publicly traded companies) of approximately \$1.1 million as of December 30, 2012 (\$3.2 million investments in non-marketable equity securities and \$3.0 million investments in marketable equity securities as of January 1, 2012). Our privately-held equity investments are accounted for under the cost method as we have less than 20% ownership interest and we do not have the ability to exercise significant influence over the operations of the privately-held companies. As noted above, these investments are periodically reviewed for other-than-temporary declines in fair value by considering available evidence, including general market conditions, financial condition, pricing in recent rounds of financing, if any, earnings and cash flow forecasts, recent operational performance and any other readily available market data. During fiscal 2012, a certain privately-held company which we are invested in at a carrying value of \$2.0 million, offered an additional round of financing that we declined to participate in. Based on this new round of financing, we determined that our initial investment was impaired and wrote off the remaining \$1.2 million investment amount. Subsequent to our fiscal year end, another privately-held company which we are invested in at a carrying value of \$2.0 million, also offered another round of financing which effectively diluted our initial investment. Based on this new round of financing, we determined that our initial investment was impaired and wrote off the entire \$2.0 million investment amount. Refer to Note 20 for additional information on this subsequent event. These impairment losses of \$3.2 million were recognized in "Interest and other income, net" in fiscal 2012, and we classified the investment as Level 3 asset due to the absence of quoted market prices and inherent lack of liquidity.

In February 2012, we entered into a Stock Purchase Agreement (the "Agreement") with a company that designs, develops and manufactures products in the area of advanced battery storage for mobile consumer devices. Pursuant to the terms of the Agreement, we purchased approximately \$6.0 million of preferred stock from the company and have committed to purchase additional preferred stock in a series of subsequent closings subject to certain performance milestones that must be fulfilled within a defined and agreed upon timeline. Of our total commitment of \$78.6 million, we plan to purchase additional preferred stock of approximately \$10.5 million in fiscal 2013. We plan to invest \$60.8 million in fiscal 2014 and \$7.3 million in fiscal 2015 subject to the attainment of certain milestones and the timing of additional capital requests which could vary substantially. As of December 30, 2012, we own less than 10% of the company. If our future commitments are fully funded, we could become their majority shareholder and consolidate the financial results of this company. As of December 30, 2012, our initial investment of \$6.0 million was recorded as part of our investments in non-marketable equity securities.

In fiscal 2011, we recognized an impairment loss of approximately \$0.8 million related our investment in a certain privately-held company with an original carrying cost of \$2.0 million. We had no impairment charges against our privately-held equity investments in fiscal 2010.

During fiscal 2010, we sold our equity investment in one publicly traded company for \$4.7 million and recognized a gain of \$3.6 million in "Interest and other income, net". We did not sell any investments in marketable equity securities in fiscal 2012 and 2011.

There were no significant transfers between Level 1, Level 2 and Level 3 fair value hierarchies during fiscal 2012 and 2011.

## NOTE 6. INVESTMENTS

### Available-For-Sale Securities and Other Investments

The following tables summarize our available-for-sale securities and other investments:

	As of December 30, 2012				As of January 1, 2012			
	Cost	Gross Unrealized Gains	Gross Unrealized Losses	Fair Value	Cost	Gross Unrealized Gains	Gross Unrealized Losses	Fair Value
	(In thousands)							
Reported as cash equivalents:								
Money market funds	\$ 24,187	\$ —	\$ —	\$ 24,187	\$ 77,952	\$ —	\$ —	\$ 77,952
Corporate notes and bonds	—	—	—	—	1,341	—	(1)	1,340
Total cash equivalents	<u>24,187</u>	<u>—</u>	<u>—</u>	<u>24,187</u>	<u>79,293</u>	<u>—</u>	<u>(1)</u>	<u>79,292</u>
Reported as short-term investments:								
Corporate notes and bonds	28,430	13	(8)	28,435	33,010	33	(15)	33,028
Federal agency	3,005	—	—	3,005	15,526	4	(6)	15,524
U.S. treasuries	10,023	9	—	10,032	10,004	68	—	10,072
Commercial paper	11,692	2	—	11,694	7,189	1	(1)	7,189
Certificates of deposit	840	—	—	840	801	—	(1)	800
Asset-held-for-sale	6,913	—	(2,283)	4,630	6,913	—	—	6,913
Total short-term investments	<u>60,903</u>	<u>24</u>	<u>(2,291)</u>	<u>58,636</u>	<u>73,443</u>	<u>106</u>	<u>(23)</u>	<u>73,526</u>
Reported as long-term investments:								
Auction rate securities	5,900	—	(396)	5,504	20,900	—	(1,896)	19,004
Marketable equity securities (1)	<u>1,030</u>	<u>70</u>	<u>(46)</u>	<u>1,054</u>	<u>3,253</u>	<u>—</u>	<u>(240)</u>	<u>3,013</u>
Total long-term investments	<u>6,930</u>	<u>70</u>	<u>(442)</u>	<u>6,558</u>	<u>24,153</u>	<u>—</u>	<u>(2,136)</u>	<u>22,017</u>
Total available-for-sale securities and other investments	<u>\$ 92,020</u>	<u>\$ 94</u>	<u>\$ (2,733)</u>	<u>\$ 89,381</u>	<u>\$ 176,889</u>	<u>\$ 106</u>	<u>\$ (2,160)</u>	<u>\$ 174,835</u>

(1) The \$0.4 million of gross unrealized losses were related to ARS that had been in a continuous loss position for 12 months or more. As of January 1, 2012, \$1.9 million of the \$2.2 million gross unrealized losses were related to ARS that had been in a continuous loss position for 12 months or more. For individual marketable equity securities with unrealized losses, we evaluated the near-term prospects in relation to the severity and duration of the impairment. Based on that evaluation and our ability and intent to hold these investments for a reasonable period of time, we did not consider these investments to be other-than-temporarily impaired as of December 30, 2012 and January 1, 2012.

As of December 30, 2012, the contractual maturities of our available-for-sale investments and certificates of deposit were as follows (the table below does not include our investments in marketable equity securities):

	<u>Cost</u>	<u>Fair Value</u>
	(In thousands)	
Maturing within one year	\$ 71,631	\$ 71,647
Maturing in one to three years	6,547	6,547
Maturing in more than three years	<u>5,900</u>	<u>5,504</u>
Total	<u>\$ 84,078</u>	<u>\$ 83,698</u>

Realized gains and realized losses from sales of available-for-sale in fiscal 2012, 2011 and 2010 were not material.

Proceeds from sales or maturities of available-for-sale investments were \$139.8 million, \$218.6 million and \$32.5 million for fiscal 2012, 2011 and 2010, respectively.

## **NOTE 7. ASSETS HELD FOR SALE**

### **Texas Facility**

The manufacturing facility located in Round Rock, Texas ceased operations in fiscal 2008. The net book value of the remaining restructured assets that were classified as held for sale and included in “Other current assets” in the Consolidated Balance Sheets was \$4.6 million as of December 30, 2012 and \$6.9 million as of January 1, 2012 and January 2, 2011. In fiscal 2012, management reassessed the fair value of the assets account due to the continuing unfavorable economic and market conditions. Based on this analysis, we recorded a write-down of \$2.3 million. No impairment was recognized in fiscal 2011 and 2010. We continue to incur expenses related to ongoing maintenance and upkeep of the Texas facility until we complete the sale of the property.

### **Building**

In the second quarter of fiscal 2011, we vacated one of our buildings located in San Jose, California and in the third quarter of fiscal 2011, we began to market the building for sale or lease. In the third quarter of 2011, based upon our analysis of other comparable building sales in the area, we determined that the fair market value of the building was less than the carrying value, accordingly, we recorded an impairment charge of approximately \$2.0 million to reduce the carrying value of the building to the estimated current market value of approximately \$5.2 million. In the fourth quarter of fiscal 2011, we completed the sale of the building to a third party for approximately \$5.1 million. The loss that we realized from the sale of the building was not material to the consolidated financial statements.

## **NOTE 8. EMPLOYEE STOCK PLANS AND STOCK-BASED COMPENSATION**

Our equity incentive plans are broad-based, long-term programs intended to attract and retain talented employees and align stockholder and employee interests.

We currently have the following employee stock plans:

### 1999 Stock Option Plan (“1999 Plan”):

Under the terms of the 1999 Plan, which was a non-shareholder approved plan, stock options could have been granted to qualified employees, including those of acquired companies and consultants of the Company or its subsidiaries, but stock options could not be granted to executive officers or directors. There are currently no shares available for grant under the 1999 Plan as the plan expired in March 2009. All unissued grants became unavailable for future grant.

#### 1994 Amended Stock Option Plan (“1994 Amended Plan”):

In fiscal 1994, our board of directors adopted the 1994 Stock Plan (the “1994 Plan”). The 1994 Plan was most recently amended in fiscal 2011 (the “1994 Amended Plan”). The 1994 Amended Plan provides for (1) the discretionary granting of stock options, restricted stock units (“RSUs”), restricted stock awards (“RSAs”) and stock appreciation rights (“SARs”) to qualified employees, consultants and outside directors, which options may be either incentive stock options (for employees only) or non-statutory stock options, as determined at the time of grant and (2) the grant of non-statutory stock options, SARs, RSAs or RSUs to outside directors pursuant to an automatic, non-discretionary formula. Options or awards granted under the 1994 Amended Plan become exercisable over a vesting period of generally five years and generally expire over terms not exceeding eight years from the date of grant, subject to earlier termination upon the cessation of employment or service of the recipients. At the annual meeting in 2011, our stockholders approved an increase of 15 million shares to the number of shares that can be issued under the 1994 Amended Plan. The maximum aggregated number of shares authorized for issuance under the 1994 Amended Plan is 145.2 million shares. As of December 30, 2012, approximately 14.8 million shares of stock options or 7.9 million shares of RSUs and RSAs were available for grant under the 1994 Amended Plan. The 1994 Amended Plan will expire in January 2014.

#### 2012 Incentive Award Plan (“2012 Plan”):

In connection with our acquisition of Ramtron, we assumed their 2012 Plan, as amended, which reserves a total of 1.2 million shares of common stock for issuance under stock option or restricted stock grants. The exercise price of all non-qualified stock options must be no less than 100% of the fair market value on the effective date of the grant under the 2012 Plan, and the maximum term of each grant is seven years. The 2012 Plan permits the issuance of incentive stock options, the issuance of restricted stock, and other types of awards. Restricted stock grants generally vest five years from the date of grant. Options granted become exercisable in full or in installments pursuant to the terms of each agreement evidencing options granted. The exercise of stock options and issuance of restricted stock and restricted stock units is satisfied by issuing authorized common stock or treasury stock. Grants from this plan are limited to employees who joined Cypress as part of the Ramtron acquisition and grants to new Cypress employees. As of December 30, 2012, approximately 1.2 million shares of stock options or 0.7 million shares of RSUs and RSAs were available for grant under the 2012 Plan.

#### Employee Stock Purchase Plan (“ESPP”):

Our ESPP allows eligible employees to purchase shares of our common stock through payroll deductions. The ESPP contains consecutive 18-month offering periods composed of three six-month exercise periods. The shares can be purchased at the lower of 85% of the fair market value of the common stock at the date of commencement of the offering period or at the last day of each six-month exercise period. Purchases are limited to 10% of an employee’s eligible compensation, subject to a maximum annual employee contribution limit of \$21,250. As of December 30, 2012, approximately 3.7 million shares were available for future issuance under the ESPP.

### **Outstanding Employee Equity Awards**

In conjunction with the SunPower Spin-Off which we completed in fiscal 2008, the Board approved certain adjustments to our 1999 Plan and 1994 Amended Plan (together, the “Plans”). Specifically, the Board approved amendments to make proportionate adjustments to, among other things, outstanding employee equity awards, including stock options, restricted stock units and restricted stock awards under the Plans to preserve the intrinsic value of the awards before and after the Spin-Off. These changes included a proportionate adjustment in the number of shares issuable pursuant to the outstanding awards and the per-share exercise price of the options.

The Board also approved certain adjustments with respect to our ESPP to offset the decrease in our common stock price resulting from the Spin-Off. These changes included a proportionate adjustment in the offering date price per share of our common stock and maximum number of shares participants may purchase under the ESPP.

The modification of the outstanding employee equity awards and the ESPP related to the Spin-Off resulted in additional non-cash stock-based compensation. The amount was measured based upon the difference between the fair value of the awards immediately before and after the modification. Of the total additional non-cash stock-based compensation, \$1.1 million, \$5.5 million and \$17.1 million, net of estimated forfeitures, was recognized in fiscal 2012, 2011 and 2010, respectively. The remaining \$0.2 million will be recognized over the remaining vesting periods on an accelerated basis, net of estimated forfeitures.

### Stock-Based Compensation

The following table summarizes the stock-based compensation expense by line item in the Consolidated Statement of Operations:

	Year Ended		
	December 30, 2012	January 1, 2012	January 2, 2011
	(In thousands)		
Cost of revenues	\$ 18,519	\$ 23,730	\$ 22,714
Research and development	19,800	24,297	21,541
Selling, general and administrative	36,013	52,754	47,204
Total stock-based compensation expense	<u>\$ 74,332</u>	<u>\$ 100,781</u>	<u>\$ 91,459</u>

As stock-based compensation expense recognized in the Consolidated Statements of Operations is based on awards ultimately expected to vest, it has been adjusted for estimated forfeitures. The accounting guidance requires forfeitures to be estimated at the time of grant and revised, if necessary, in subsequent periods if actual forfeitures differ from those estimates.

Consolidated cash proceeds from the issuance of shares under the employee stock plans were \$23.8 million, \$71.2 million and \$96.9 million for fiscal 2012, 2011 and 2010, respectively. No income tax benefit was realized from stock option exercises for fiscal 2012, 2011 and 2010. As of December 30, 2012 and January 1, 2012, stock-based compensation capitalized in inventories totaled \$2.8 million and \$4.6 million, respectively.

The following table summarizes the stock-based compensation expense by type of awards:

	Year Ended		
	December 30, 2012	January 1, 2012	January 2, 2011
	(In thousands)		
Stock options	\$ 7,421	\$ 14,850	\$ 19,946
Restricted stock units and restricted stock awards	57,865	81,273	65,046
ESPP	9,046	4,658	6,467
Total stock-based compensation expense	<u>\$ 74,332</u>	<u>\$ 100,781</u>	<u>\$ 91,459</u>

The following table summarizes the unrecognized stock-based compensation balance, net of estimated forfeitures, by type of awards as of December 30, 2012:

(In thousands)		Weighted-Average Amortization Period
		(In years)
Stock options	\$ 13,192	2.02
Restricted stock units and restricted stock awards	29,602	2.67
ESPP	<u>1,973</u>	0.42
Total unrecognized stock-based compensation balance, net of estimated forfeitures	<u>\$ 44,767</u>	2.38

## Valuation Assumptions

We estimate the fair value of our stock-based equity awards using the Black-Scholes valuation model. Assumptions used in the Black-Scholes valuation model were as follows:

	Year Ended		
	December 30, 2012	January 1, 2012	January 2, 2011
<b>Stock Option Plans:</b>			
Expected life	1.1-7.2 years	2.3-7.3 years	2.3-7.0 years
Volatility	42.9%-49.6%	38.1%-51.3%	42.2%-54.5%
Risk-free interest rate	0.16%-1.5%	0.2%-2.9%	0.5%-3.1%
Dividend yield	2.8%-4.4%	1.7%-2.2%	0.0%
<b>ESPP:</b>			
Expected life	0.5-1.5 years	0.5-1.5 years	0.5-1.5 years
Volatility	44.8%-47.3%	49.8%-53.3%	44.6%-54.2%
Risk-free interest rate	0.13%-0.24%	0.04%-0.16%	0.1%-0.8%
Dividend yield	2.8%-4.4%	1.7%-2.2%	0.0%

*Expected life:* Expected life is based on historical exercise patterns, giving consideration to the contractual terms of the awards and vesting schedules. In addition, employees who display similar historical exercise behavior are grouped separately into two classes (executive officers and other employees) in determining the expected life.

*Volatility:* We determined that implied volatility of publicly traded call options and quotes from option traders is more reflective of market conditions and, therefore, can reasonably be a better indicator of expected volatility than historical volatility. Therefore, our volatility is based on a blend of historical volatility of our common stock and implied volatility.

*Risk-free interest rate:* The risk-free interest rate is based on the U.S. Treasury yield curve in effect at the time of grant.

*Dividend yield:* The expected dividend is based on our history and expected dividend payouts. Since we did not pay dividends in fiscal 2010, the expected dividend yield was zero in those years.

## Employee Equity Award Activities

### Stock Options:

The following table summarizes our stock option activities:

	Year Ended					
	December 30, 2012		January 1, 2012		January 2, 2011	
	Shares	Weighted-Average Exercise Price per Share	Shares	Weighted-Average Exercise Price per Share	Shares	Weighted-Average Exercise Price per Share
	(In thousands, except per-share amounts)					
Options outstanding, beginning of year	23,363	\$ 6.49	36,070	\$ 5.51	52,411	\$ 4.70
Assumed options from Ramtron acquisition	329	\$ 9.91	—	—	—	—
Granted	3,322	\$ 11.18	1,080	\$ 19.60	3,036	\$ 14.27
Exercised	(3,236)	\$ 4.90	(12,245)	\$ 4.51	(17,990)	\$ 4.57
Forfeited or expired	(1,018)	\$ 11.95	(1,542)	\$ 8.56	(1,387)	\$ 6.36
Options outstanding, end of year	<u>22,760</u>	\$ 7.25	<u>23,363</u>	\$ 6.49	<u>36,070</u>	\$ 5.51
Options exercisable, end of year	<u>15,432</u>	\$ 5.50	<u>15,560</u>	\$ 4.78	<u>22,924</u>	\$ 4.18

The weighted-average grant-date fair value was \$2.74 per share for options granted in fiscal 2012, \$6.34 per share in options granted during fiscal 2011 and \$5.13 per share for options granted in fiscal 2010.

The aggregate intrinsic value of the options outstanding and options exercisable as of December 30, 2012 was approximately \$93.1 million and \$83.0 million, respectively. The aggregate intrinsic value represents the total pre-tax intrinsic value which would have been received by the option holders had all option holders exercised their options as of December 30, 2012 and do not include substantial tax payments.

The aggregate pre-tax intrinsic value of option exercises, which represents the difference between the exercise price and the value of Cypress common stock at the time of exercise, was \$30.7 million in fiscal 2012, \$200.1 million in fiscal 2011 and \$157.8 million in fiscal 2010.

The aggregate grant date fair value of the options which vested in fiscal 2012, 2011 and 2010 was \$12.2 million, \$18.1 million, and \$16.3 million, respectively.

The following table summarizes information about options outstanding and exercisable as of December 30, 2012:

<u>Range of Exercise Price</u>	<u>Options Outstanding</u>			<u>Options Exercisable</u>	
	<u>Shares</u>	<u>Weighted-Average Remaining Contractual Life</u>	<u>Weighted-Average Exercise Price per Share</u>	<u>Shares</u>	<u>Weighted-Average Exercise Price per Share</u>
	<u>(In thousands)</u>	<u>(In years)</u>		<u>(In thousands)</u>	
\$1.06-\$3.52	2,758	2.90	\$ 3.12	2,599	\$ 3.13
\$3.53-\$3.53	2,605	2.16	\$ 3.53	2,558	\$ 3.53
\$3.54-\$4.72	2,497	3.44	\$ 4.05	2,429	\$ 4.05
\$4.73-\$5.18	2,847	1.26	\$ 5.05	2,795	\$ 5.05
\$5.19-\$6.17	3,500	5.45	\$ 6.03	2,022	\$ 5.98
\$6.18-\$11.02	2,582	5.06	\$ 7.77	1,907	\$ 7.44
\$11.03-\$11.27	3,065	7.97	\$ 11.27	50	\$ 11.27
\$11.28-\$23.23	2,906	6.06	\$ 16.27	1,072	\$ 15.80
	<u>22,760</u>	<u>4.30</u>	<u>\$ 7.25</u>	<u>15,432</u>	<u>\$ 5.50</u>

The total number of exercisable in-the-money options was approximately 14.3 million shares as of December 30, 2012.

As of December 30, 2012, stock options vested and expected to vest totaled approximately 21.8 million shares, with a weighted-average remaining contractual life of 4.2 years and a weighted-average exercise price of \$7.07 per share. The aggregate intrinsic value was approximately \$92.1 million.



Restricted Stock Units and Restricted Stock Awards:

The following table summarizes our restricted stock unit and restricted stock award activities:

	Year Ended					
	December 30, 2012		January 1, 2012		January 2, 2011	
	Shares	Weighted-Average Grant Date Fair Value per Share	Shares	Weighted-Average Grant Date Fair Value per Share	Shares	Weighted-Average Grant Date Fair Value per Share
	(In thousands, except per-share amounts)					
Non-vested, beginning of year	9,005	\$ 10.43	14,970	\$ 4.90	17,733	\$ 5.51
Assumed from Ramtron acquisition	188	\$ 8.69	—	—	—	—
Granted	5,606	\$ 14.44	2,228	\$ 18.97	2,228	\$ 14.78
Released	(4,969)	\$ 8.60	(6,383)	\$ 6.60	(3,866)	\$ 12.75
Forfeited	(1,943)	\$ 10.26	(1,810)	\$ 8.52	(1,125)	\$ 7.14
Non-vested, end of year	<u>7,887</u>	\$ 14.52	<u>9,005</u>	\$ 10.43	<u>14,970</u>	\$ 4.90

The balance as of December 30, 2012 included approximately 3.8 million performance-based restricted stock units granted under the 1994 Amended Plan. These performance-based awards (“PARS”) were issued to certain senior-level employees in fiscal 2012 and could be earned ratably over a period of one year, subject to the achievement of certain performance milestones set by the Compensation Committee, of the Board, (“Committee”). Upon certification and confirmation by the Committee, the earned shares for the Core Grant and Tier 1 Grant shares will be 100% vested. Tier 2 Grant shares will have a twelve-month cliff vest following certification of the milestone attainment.

In the event of overachievement in the Tier 1 and Tier 2 Grant milestones and at the discretion of the Committee, the number of shares that can be earned could exceed 100% of the shares underlying the Tier 1 and Tier 2 Grants. However, under all circumstances, the total number of shares that can be earned under all three milestones cannot exceed the maximum target shares under the 2012 PARS. If the milestones are not achieved, the shares are forfeited and cannot be earned in future periods.

In the fourth quarter of 2012, the Committee approved the performance milestone achievements for fiscal 2012. The associated awards, net of taxes, for our Named Executive Officers were vested. The achievement of fiscal 2012 PARS performance milestones were as follows:

- Core Grant—a company-wide scorecard of various individual milestones focused on financial results, cost savings, gaining additional market share, introducing new products on specific schedules and implementing various operational and customer facing systems (“Core Grant Scorecard”). This performance milestone resulted in the achievement of 51% of target in fiscal 2012.
- Tier 1 Grant—requires the Company to achieve an approved design win during calendar year 2012 at a certain large multi-national consumer electronics company utilizing certain of the Company’s new products (“Tier 1 Targeted Design Win”). This performance milestone was not achieved in fiscal 2012. As a result, no equity vested under the Tier 1 Grant program.
- Tier 2 Grant—requires the Company to grow its 2012 annual revenue at a year-over-year percentage rate (“Annual Revenue Growth Rate”) greater than a group of peer companies that it directly competes with. This performance milestone was not achieved in fiscal 2012. As a result, no equity vested under the Tier 2 Grant program.

The balances as of January 1, 2012, and January 2, 2011 included approximately 4.4 million and 8.7 million of performance-based restricted stock units and restricted stock awards, granted under the 1994 Amended Plan, respectively. These performance-based awards were issued to certain senior-level employees in fiscal 2011 and

fiscal 2010 and were earned ratably over a period of one year, subject to the achievement of certain performance milestones set by the Compensation Committee of the Board.

These performance milestones included:

- stock appreciation target against the Philadelphia Semiconductor Sector Index (“SOXX”);
- certain levels of non-GAAP free cash flows, non-GAAP operating income, non-GAAP operating expense, non-GAAP gross margin percentage, non-GAAP profit-before-taxes percentage; and
- annual revenue growth.

For the milestones not achieved, the shares were forfeited and were not earned in future periods.

We estimated the fair value of the shares with the market-condition milestone using a Monte Carlo valuation model with the following weighted-average assumptions:

	<u>Year Ended</u>		
	<u>2012 (1)</u>	<u>2011</u>	<u>2010</u>
Volatility of common stock	—	35.7%	39.8%
Volatility of the SOXX	—	25.2%	30.3%
Correlation coefficient	—	0.77	0.77
Risk-free interest rate	—	0.2%	0.3%

(1) No performance-based awards with market-conditions milestones were issued in fiscal 2012.

The fair value of the shares with the performance-related milestones was equivalent to the grant-date fair value of our common stock. In addition, we granted other performance-based and service-based restricted stock units whose fair value is typically equivalent to the grant-date fair value of our common stock.

ESPP:

During fiscal 2012, 2011 and 2010, we issued 0.7 million, 1.8 million and 2.6 million shares under our ESPP with weighted-average price of \$11.36, \$9.11 and \$5.59 per share, respectively.

## NOTE 9. BALANCE SHEET COMPONENTS

### Accounts Receivable, Net

	As of	
	December 30, 2012	January 1, 2012
	(In thousands)	
Accounts receivable, gross	\$ 87,050	\$ 107,433
Allowances for doubtful accounts receivable and sales returns	(4,130)	(3,909)
Accounts receivable, net	<u>\$ 82,920</u>	<u>\$ 103,524</u>

### Inventories

	As of	
	December 30, 2012	January 1, 2012
	(In thousands)	
Raw materials	\$ 4,307	\$ 4,474
Work-in-process	62,603	63,552
Finished goods	60,686	24,278
Total inventories	<u>\$ 127,596</u>	<u>\$ 92,304</u>

In connection with the acquisition of Ramtron we acquired \$40.7 million of inventory.

### Other Current Assets

	As of	
	December 30, 2012	January 1, 2012
	(In thousands)	
Prepaid expenses	\$ 13,945	\$ 24,664
Assets held for sale (see Note 7)	4,630	6,913
Prepaid to Grace—current portion	7,321	2,164
Other current assets	15,186	9,751
Total other current assets	<u>\$ 41,082</u>	<u>\$ 43,492</u>

### Property, Plant and Equipment, Net

	As of	
	December 30, 2012	January 1, 2012
	(In thousands)	
Land	\$ 19,563	\$ 17,655
Equipment	1,021,642	1,013,517
Buildings, building and leasehold improvements	237,629	201,793
Furniture and fixtures	7,864	9,334
Total property, plant and equipment, gross	1,286,698	1,242,299
Less: accumulated depreciation and amortization	(1,012,271)	(957,320)
Total property, plant and equipment, net	<u>\$ 274,427</u>	<u>\$ 284,979</u>

## Other Long-term Assets

	As of	
	December 30, 2012	January 1, 2012
	(In thousands)	
Employee deferred compensation plan (see Note 16)	\$ 37,142	\$ 32,976
Investments:		
Debt securities (see Note 5)	5,504	19,004
Equity securities (see Note 5)	7,054	6,213
Prepaid to Grace—long-term portion	—	5,957
Other assets	25,284	14,849
Total other assets	<u>\$ 74,984</u>	<u>\$ 78,999</u>

### *Pre-payment to Grace*

In fiscal 2010 and 2011, we made certain pre-payments to Grace Semiconductor Manufacturing Corporations (“Grace”), a strategic foundry partner, to secure a certain supply of wafers. The pre-payments made in fiscal 2011 are expected to be applied to purchases of wafers from Grace over a period of two years commencing from February 23, 2011. At December 30, 2012, the unapplied pre-payment balance was \$7.3 million was recorded as part of “Other current assets” in the 2012 Consolidated Balance Sheet.

## Other Current Liabilities

	As of	
	December 30, 2012	January 1, 2012
	(In thousands)	
Employee deferred compensation plan (see Note 16)	\$ 36,244	\$ 32,485
Restructuring accrual (see Note 10)	5,113	4,061
Capital lease—current portion	4,849	2,257
Equipment loan—current portion (see Note 14)	2,725	2,725
Advances received from sale of ARS (see Note 5)	3,140	—
Other current liabilities	46,218	21,402
Total other current liabilities	<u>\$ 98,289</u>	<u>\$ 62,930</u>

### *Deferred Income Taxes and Other Tax Liabilities*

	As of	
	December 30, 2012	January 1, 2012
	(In thousands)	
Deferred income taxes	\$ —	\$ 165
Non-current tax liabilities	40,928	38,445
Total deferred income taxes and other tax liabilities	<u>\$ 40,928</u>	<u>\$ 38,610</u>

### Other Long-Term Liabilities

	As of	
	December 30, 2012	January 1, 2012
	(In thousands)	
Equipment loan—long term portion (see Note 14)	\$ 8,756	\$ 12,982
Capital lease—long term portion	12,779	11,413
Advances received from the sale of ARS (see Note 5)	—	16,390
Other long term liabilities	11,557	6,393
	<u>\$ 33,092</u>	<u>\$ 47,178</u>

### NOTE 10. RESTRUCTURING

We recorded restructuring charges of \$4.3 million, \$6.3 million and \$3.0 million during fiscal 2012, 2011 and 2010, respectively. The determination of when we accrue for severance and benefits costs depends on whether the termination benefits are provided under a one-time benefit arrangement or under an on-going benefit arrangement. As of December 30, 2012 and January 1, 2012, outstanding restructuring liability amounted to approximately \$5.1 million and \$4.1 million, respectively.

The following table summarizes the restructuring charges recorded in the Consolidated Statements of Operations:

	Year Ended		
	December 30, 2012	January 1, 2012	January 2, 2011
	(In thousands)		
Fiscal 2011/12 Restructuring Plan	\$ 3,696	\$ 5,043	\$ —
Fiscal 2010 Restructuring Plan	300	1,524	2,243
Fiscal 2008/9 Restructuring Plan	—	(424)	995
Fiscal 2007 Restructuring Plan	262	193	(263)
Total restructuring charges	<u>\$ 4,258</u>	<u>\$ 6,336</u>	<u>\$ 2,975</u>

### Fiscal 2011/12 Restructuring Plan

In fiscal 2011, we initiated a restructuring plan which allows us to continue to allocate and align our resources to the business units that we expect will drive future development and revenue growth (“Fiscal 2011/12 Restructuring Plan”). Restructuring activities related to personnel costs, which are primarily in the U.S., are summarized as follows:

(In thousands)	
Initial provision	\$ 5,043
Cash payments	(2,925)
Non-cash charges	(163)
Balance as of January 1, 2012	1,955
Provision	3,696
Cash payments	(1,145)
Balance as of December 30, 2012	<u>\$ 4,506</u>

Restructuring liability under the Fiscal 2011/12 Restructuring Plan related primarily to personnel costs which are expected to be paid out within the next twelve months.

## Fiscal 2010 Restructuring Plan

During the third quarter of fiscal 2010, we implemented a restructuring plan to exit certain of our back-end manufacturing operations located in the Philippines (“Fiscal 2010 Restructuring Plan”). These actions were intended to reduce the cost of our back-end manufacturing by selling our labor intensive assembly operations to a lower cost third-party subcontractor in China and by the continued shifting of these operations to our fully automated back-end processes.

To date, we recorded total restructuring charges of \$4.1 million under the Fiscal 2010 Restructuring Plan, which was all related to personnel costs. As of December 30, 2012, the outstanding restructuring liability under the Fiscal 2010 Restructuring Plan was \$0.3 million and was primarily related to severance and benefits of our employees. We expect to substantially complete the activities and fully pay out the remaining restructuring liability under this program within the next twelve months.

The restructuring activities related to personnel costs are summarized as follows:

<u>(In thousands)</u>	
Initial provision	\$ 2,243
Cash payments	<u>(37)</u>
Balance as of January 2, 2011	2,206
Provision	1,524
Cash payments	<u>(1,845)</u>
Balance as of January 1, 2012	\$ 1,885
Provision	300
Cash payments	(1,787)
Non-cash charges	<u>(11)</u>
Balance as of December 30, 2012	<u>\$ 387</u>

## Fiscal 2008/9 Restructuring Plan

In fiscal 2008, we initiated a restructuring plan as part of a companywide cost saving initiative, which continued into 2010, that was aimed to reduce operating costs in response to the economic downturn (“Fiscal 2008/9 Restructuring Plan”). In the third quarter of fiscal 2011, we completed the remaining actions we had for this plan and the remaining balance of approximately \$1.1 million as of the January 2, 2011 was fully settled during the third quarter of fiscal 2011. From initial provision through the third quarter of fiscal 2011, we recorded a total of \$27.4 million under the Fiscal 2008/9 Restructuring Plan, of which \$23.8 million was related to personnel costs and \$3.6 million was related to other exit costs.

## NOTE 11. FOREIGN CURRENCY DERIVATIVES

We operate and sell products in various global markets and purchase capital equipment using the U.S. dollar and foreign currencies. As a result, we are exposed to risks associated with changes in foreign currency exchange rates. We may use various hedge instruments from time to time to manage the exposures associated with purchases of foreign sourced equipment, net asset or liability positions of our subsidiaries and forecasted revenues and expenses. We do not enter into foreign currency derivative financial instruments for speculative or trading purposes. The counterparties to these hedging transactions are creditworthy multinational banks and the risk of counterparty nonperformance associated with these contracts is not considered to be material as of December 30, 2012. We estimate the fair value of our forward contracts based on spot and forward rates from published sources.

We record hedges of certain foreign currency denominated monetary assets and liabilities at fair value at the end of each reporting period with the related gains or losses recorded in “Interest and other income, net” in the Consolidated Statements of Operations. The gains or losses on these contracts are substantially offset by

transaction gains or losses on the underlying balances being hedged. There were no outstanding forward contract hedges as of December 30, 2012 and January 1, 2012.

#### NOTE 12. ACCUMULATED OTHER COMPREHENSIVE LOSS

The components of accumulated other comprehensive loss were as follows:

	As of	
	December 30, 2012	January 1, 2012
	(In thousands)	
Accumulated net unrealized losses on available-for-sale investments	\$ (61)	\$(1,551)
Other	(383)	(389)
Total accumulated other comprehensive loss	<u>\$(444)</u>	<u>\$(1,940)</u>

#### NOTE 13. INTEREST AND OTHER INCOME, NET

The following table summarizes the components of “Interest and other income, net,” recorded in the Consolidated Statements of Operations:

	Year Ended		
	December 30, 2012	January 1, 2012	January 2, 2011
	(In thousands)		
Interest income	\$ 694	\$ 1,466	\$ 2,515
Interest expense	(3,824)	(115)	(19)
Changes in fair value of investments under the deferred compensation plan	3,158	(862)	2,653
Impairment of investments	(3,200)	(800)	—
Foreign currency exchange gains (losses), net	(1,460)	1,124	(2,452)
Gain on sale of equity investments	1,601	—	3,628
Others	286	1,046	(23)
Total interest and other income, net	<u>\$ (2,745)</u>	<u>\$ 1,859</u>	<u>\$ 6,302</u>

#### NOTE 14. DEBT AND EQUITY TRANSACTIONS

##### *Mortgage Note*

As part of our acquisition of Ramtron, we acquired a loan facility with a lender. We have a promissory note with the original principal amount of \$4.2 million, with a maturity date of January 1, 2016, bearing interest at 6.17%. We are obligated to make monthly principal and interest payments of \$30,500 until January 2016, with a balloon payment of \$2.8 million in January 2016. This loan is secured and collateralized with real estate located at Colorado Springs, Colorado. The outstanding balance at the end of fiscal 2012 is \$3.3 million. In February 2013, we notified the lender of our intent to pay the remaining total outstanding amount on June 1, 2013.

##### *Senior Secured Revolving Credit Facility*

On June 26, 2012, we entered into a five-year senior secured revolving credit facility (“Credit Facility”) with a group of lenders led by Morgan Stanley Senior Funding, Inc. The Credit Facility enables us to borrow up to \$430 million on a revolving basis. Borrowing terms vary based on the type of borrowing with all outstanding balances being due at the credit facility termination date, or June 25, 2017. Outstanding amounts may be repaid prior to maturity without penalty and are mandatory for certain asset sales and casualty events. The current

outstanding borrowings bear interest at LIBOR plus 2.25% on the drawn amount. There is a commitment fee payable of 0.375% per annum on any undrawn amounts. The Credit Facility contains customary affirmative, negative and financial covenants for similarly rated companies. The financial covenants include the following conditions: 1) maximum senior secured leverage ratio of 2.00 to 1.00, 2) maximum total leverage ratio of 3.50 to 1.00 through June 30, 2013 and 3.00 to 1.00 thereafter, 3) minimum fixed charge coverage ratio of 1.20 to 1.00, and 4) minimum liquidity of at least \$150 million. Borrowings are secured by substantially all assets of the company. At December 30, 2012, our outstanding borrowings of \$232 million were recorded as part of long-term liabilities and are presented as “Loan payable” in the Consolidated Balance Sheet. As of December 30, 2012, we were in compliance with all of the financial covenants under the Credit Facility.

***Line of Credit***

On March 28, 2012, we amended our revolving line of credit with Silicon Valley Bank to increase the available borrowing from \$5 million to \$55 million and to extend the maturity date to March 27, 2013. On March 29, 2012, we borrowed \$50 million under this line of credit. On June 26, 2012 we repaid the outstanding balance of \$50 million and accrued interest and terminated the revolving line of credit, replacing it with a secured revolving credit facility.

***Equipment Loans***

In December 2011, we obtained equipment loans from a certain financial institution for an aggregate amount of approximately \$14.1 million. These loans are collateralized by certain of our manufacturing equipment and bear interest of 3.15% to 3.18% per annum and are payable in 60 equal installments with the first installments due in January 2012. The related master loan agreement includes a variety of standard covenants including restrictions on merger with another company without consent (which shall not be unreasonably withheld), liquidation or dissolution, and distribution, lease or transfer of our ownership interest in these properties or assets. Of the \$11.5 million outstanding balance as of December 30, 2012, approximately \$2.7 million was recorded as part of “Other current liabilities” and \$8.8 million was recorded as part of “Other long-term liabilities” in the 2012 Consolidated Balance Sheet. At December 30, 2012, the fair value of the equipment loans approximated the carrying value. The fair value was estimated using discounted cash flow analysis using relevant factors that might affect the fair value, such as present value factors and risk-free interest rates based on the U.S. Treasury yield curve.

The schedule of principal payments under our equipment loans is as follows:

<u>Fiscal Year</u>	<u>(In thousands)</u>
2013	\$ 2,737
2014	2,825
2015	2,915
2016	<u>3,009</u>
Total	<u>\$11,486</u>

***Stock Buyback Programs:***

*\$400 Million Program Authorized in Fiscal 2011*

On September 20, 2011, our Board authorized a new \$400.0 million stock buyback program. The program allows us to purchase our common stock or enter into equity derivative transactions related to our common stock. The timing and actual amount expended with the new authorized funds will depend on a variety of factors including the market price of our common stock, regulatory, legal, and contractual requirements, and other market factors. The program does not obligate us to repurchase any particular amount of common stock and may be modified or suspended at any time at the discretion of our board of directors. From September 2011 through the end of fiscal 2012, we used approximately \$311.6 million from this program to repurchase approximately



23.1 million shares at an average share price of \$13.49. As of December 30, 2012, \$88.4 million remained available for future stock repurchases

#### *\$600 Million Program Authorized in Fiscal 2010*

The \$600.0 million stock buyback program approved and authorized by our Board in October 2010 was completed in the third quarter of fiscal 2011. We repurchased a total of 32.6 million shares at an average share price of \$18.38 under this program (30.9 million shares at an average share price of \$18.46 were repurchased in fiscal 2011 and 1.7 million shares at an average share price of \$17.07 were purchased in fiscal 2010). Of the 30.9 million shares repurchased in fiscal 2011, 9.5 million shares were repurchased through our yield enhancement program.

#### **Yield Enhancement Program:**

In fiscal 2009, the Audit Committee approved a yield enhancement strategy intended to improve the yield on our available cash. As part of this program, the Audit Committee authorized us to enter into short-term yield enhanced structured agreements, typically with maturities of 90 days or less, correlated to our stock price. Under the agreements we entered into to date, we pay a fixed sum of cash upon execution of an agreement in exchange for the financial institution's obligations to pay either a pre-determined amount of cash or shares of our common stock depending on the closing market price of our common stock on the expiration date of the agreement. Upon expiration of each agreement, if the closing market price of our common stock is above the pre-determined price, we will have our cash investment returned plus a yield substantially above the yield currently available for short-term cash investments. If the closing market price is at or below the pre-determined price, we will receive the number of shares specified at the agreement's inception. As the outcome of these arrangements is based entirely on our stock price and does not require us to deliver either shares or cash, other than the original investment, the entire transaction is recorded in equity.

We enter into a yield enhanced structured agreement based upon a comparison of the yields available in the financial markets for similar maturities against the expected yield to be realized per the structured agreement and the related risks associated with this type of arrangement. We believe the risk associated with these types of agreements is no different than alternative investments available to us with equivalent counterparty credit ratings. All counterparties to a yield enhancement program have a credit rating of at least Aa2 or A as rated by major independent rating agencies. For all such agreements that matured to date, the yields of the structured agreements were far superior to the yields available in the financial markets primarily due to the volatility of our stock price and the pre-payment aspect of the agreements. The counterparty is willing to pay a premium over the yields available in the financial markets due to the structure of the agreement.

The following table summarizes the activity of our settled yield enhanced structured agreements during fiscal 2012, 2011 and 2010:

<u>Periods</u>	<u>Aggregate Price Paid</u>	<u>Total Cash Proceeds Received Upon Maturity</u>	<u>Yield Realized</u>	<u>Total Number of Shares Received Upon Maturity</u>	<u>Average Price Paid per Share</u>
	(In thousands, except per-share amounts)				
<b>Fiscal 2012:</b>					
Settled through cash proceeds	\$ 14,498	\$ 14,931	\$ 433	—	\$ —
Settled through issuance of common stock	—	—	—	—	—
Total for fiscal 2012	<u>\$ 14,498</u>	<u>\$ 14,931</u>	<u>\$ 433</u>	<u>—</u>	<u>\$ —</u>
<b>Fiscal 2011:</b>					
Settled through cash proceeds (1)	\$ 137,798	\$ 143,798	\$ 6,000	—	\$ —
Settled through issuance of common stock (2)	180,636	—	—	9,500	\$ 19.01
Total for fiscal 2011	<u>\$ 318,434</u>	<u>\$ 143,798</u>	<u>\$ 6,000</u>	<u>9,500</u>	<u>\$ 19.01</u>
<b>Fiscal 2010:</b>					
Settled through cash proceeds	\$ 207,882	\$ 217,489	\$ 9,607	—	\$ —
Settled through issuance of common stock	114,917	—	—	10,000	\$ 11.49
Total for fiscal 2010	<u>\$ 322,799</u>	<u>\$ 217,489</u>	<u>\$ 9,607</u>	<u>10,000</u>	<u>\$ 11.49</u>

(1) This includes a YEP agreement entered into in fiscal 2010 for an aggregate price of approximately \$43.9 million which remained unsettled as of the end of fiscal 2010. Such agreement was subsequently settled in the first quarter of fiscal 2011 for approximately \$47.0 million.

(2) Included as part of the \$600 million stock buyback program authorized in fiscal 2010.

## Dividends

During fiscal 2012, we paid total cash dividends of \$63.2 million, consisting of dividends of \$0.09 per share of common stock paid in the first quarter of the fiscal year and dividends of \$0.11 per share of common stock paid in the second, third and fourth quarters of the fiscal year. On November 12, 2012 our Board declared a cash dividend of \$0.11 per share payable to holders of record of our common stock at the close of business day on December 27, 2012. This cash dividend was paid on January 17, 2013 and totaled approximately \$15.8 million.

We initiated our first ever dividend program in the second quarter of fiscal 2011 and our Board declared cash dividends of \$0.09 per share payable in the third and fourth quarters of fiscal 2011. Total cash dividends paid in fiscal 2011 were approximately \$29.0 million.

No cash dividends were declared or paid in fiscal 2010.

## NOTE 15. NET INCOME (LOSS) PER SHARE

Basic net income (loss) per share is computed using the weighted-average common shares outstanding. Diluted net income per share is computed using the weighted-average common shares outstanding and any dilutive potential common shares. Diluted net loss per common share is computed using the weighted-average common shares outstanding and excludes all dilutive potential common shares when we are in a net loss position their inclusion would be anti-dilutive. Our dilutive securities primarily include stock options, restricted stock units and restricted stock awards.

The following table sets forth the computation of basic and diluted net income (loss) per share:

	Year Ended		
	December 30, 2012	January 1, 2012	January 2, 2011
	(In thousands, except per-share amounts)		
<b>Net Income (Loss) per Share—Basic:</b>			
Net income (loss) attributable to Cypress for basic computation	\$ (22,370)	\$ 167,839	\$ 75,742
Weighted-average common shares for basic computation	149,266	164,495	161,114
Net income (loss) per share—basic	\$ (0.15)	\$ 1.02	\$ 0.47
<b>Net Income (Loss) per Share—Diluted:</b>			
Net income (loss) attributable to Cypress for diluted computation	\$ (22,370)	\$ 167,839	\$ 75,742
Weighted-average common shares for basic computation	149,266	164,495	161,114
Effect of dilutive securities:			
Stock options, restricted stock units, restricted stock awards and other	—	22,400	30,263
Weighted-average common shares for diluted computation	149,266	186,895	191,377
Net income (loss) per share—diluted	\$ (0.15)	\$ 0.90	\$ 0.40

Anti-Dilutive Securities:

The following securities were excluded from the computation of diluted net income (loss) per share as their impact was anti-dilutive:

	Year Ended		
	December 30, 2012	January 1, 2012	January 2, 2011
	(In thousands)		
Stock options, restricted stock units and restricted stock awards	14,440	1,814	1,421

**NOTE 16. EMPLOYEE BENEFIT PLANS**

**Key Employee Bonus Plan (“KEBP”)**

We have a key employee bonus plan, which provides for incentive payments to certain key employees including all executive officers except the Chief Executive Officer. Payments under the plan are determined based upon certain performance measures, including actual PBT% or our actual earnings per share, depending on the year, compared to a target as well as achievement of strategic, operational and financial goals established for each key employee. We recorded total charges of \$0.2 million under the plan in fiscal 2012, \$9.5 million in fiscal 2011 and \$12.8 million in fiscal 2010.

**Performance Profit Sharing Plan (“PPSP”)**

We have a performance profit sharing plan, which provides incentive payments to all our employees. Payments under the plan are determined based upon our earnings per share and the employees’ percentage of success in achieving certain performance goals. We recorded total charges of \$0.3 million under the plan in fiscal 2012, \$3.7 million in fiscal 2011 and \$5.0 million in fiscal 2010.

**Performance Bonus Plan**

We have a performance bonus plan which provides for incentive payments to executive officers and key employees who are recommended by our senior management and approved solely at the discretion of the Committee of the Board. Payments under the plan are determined based upon the attainment and certification of certain objective performance criteria established by the Committee. The sole participant in the performance

bonus plan for fiscal 2012, 2011 and 2010 was our Chief Executive Officer. Under the plan, we recorded total charges of \$0.8 million and \$1.1 million in fiscal 2011 and 2010, respectively. In fiscal 2012, the total charges were immaterial.

### Deferred Compensation Plan

We have a deferred compensation plan, which provides certain key employees, including our executive management, with the ability to defer the receipt of compensation in order to accumulate funds for retirement on a tax-free basis. We do not make contributions to the deferred compensation plan or guarantee returns on the investments. Participant deferrals and investment gains and losses remain our assets and are subject to claims of general creditors.

Under the deferred compensation plan the assets are recorded at fair value in each reporting period with the offset being recorded in "Other income (expense), net." The liabilities are recorded at fair value in each reporting period with the offset being recorded as an operating expense or income. As of December 30, 2012 and January 1, 2012, the fair value of the assets was \$37.1 million and \$33.0 million, respectively, and the fair value of the liabilities was \$36.2 million and \$32.5 million, respectively.

All expense and income recorded under the deferred compensation plan were included in the following line items in the Consolidated Statements of Operations:

	Year Ended		
	December 30, 2012	January 1, 2012	January 2, 2011
	(In thousands)		
Changes in fair value of assets recorded in:			
Interest and other income, net	\$ 3,157	\$ (862)	\$ 2,653
Changes in fair value of liabilities recorded in:			
Cost of revenues	(372)	111	(370)
Research and development expenses	(568)	114	(959)
Selling, general and administrative expenses	(1,710)	460	(1,726)
Total income (expense), net	<u>\$ 507</u>	<u>\$ (177)</u>	<u>\$ (402)</u>

### 401(k) Plan

We sponsor a 401(k) plan which provides participating employees with an opportunity to accumulate funds for retirement. We do not make contributions to the 401(k) plan.

### Pension Plans

We sponsor defined benefit pension plans covering employees in certain of our international locations. We do not have defined-benefit pension plans for our United States-based employees. Pension plan benefits are based primarily on participants' compensation and years of service credited as specified under the terms of each country's plan. The funding policy is consistent with the local requirements of each country.

As of December 30, 2012 and January 1, 2012, projected benefit obligations totaled \$8.0 million and \$5.6 million, respectively, and the fair value of plan assets was \$3.3 million and \$2.8 million, respectively.

## NOTE 17. INCOME TAXES

The geographic distribution of income (loss) before income taxes and the components of income tax benefit (provision) are summarized below:

	Year Ended		
	December 30, 2012	January 1, 2012	January 2, 2011
	(In thousands)		
United States loss	\$ (127,532)	\$ (3,546)	\$ (86,630)
Foreign income	105,872	159,124	180,796
Income (loss) before income taxes	<u>(21,660)</u>	<u>155,578</u>	<u>94,166</u>
Income tax benefit (provision):			
Current tax benefit (expense):			
Federal	1,106	15,641	(6,621)
State	65	336	30
Foreign	(5,353)	(4,111)	(5,245)
Total current tax benefit (expense)	<u>(4,182)</u>	<u>11,866</u>	<u>(11,836)</u>
Deferred tax benefit (expense):			
Foreign	1,858	(487)	(7,454)
Total deferred tax benefit (expense)	<u>1,858</u>	<u>(487)</u>	<u>(7,454)</u>
Income tax benefit (provision)	<u>\$ (2,324)</u>	<u>\$ 11,379</u>	<u>\$ (19,290)</u>

Income tax benefit (provision) differs from the amounts obtained by applying the statutory United States federal income tax rate to income (loss) before taxes as shown below:

	Year Ended		
	December 30, 2012	January 1, 2012	January 2, 2011
	(In thousands)		
Benefit (provision) at U.S. statutory rate of 35%	\$ 7,581	\$ (54,452)	\$ (32,958)
Foreign income at other than U.S. rates	26,364	43,647	43,408
Future benefits not recognized	(38,190)	(34,124)	(30,167)
Recognition of prior-year benefits	—	29,186	—
Reversal of previously accrued taxes	3,985	22,395	1,050
Effect of stock-based compensation	—	3,907	—
Tax planning for acquisitions	(1,982)	—	—
Refundable tax credits	(268)	1,049	437
State income taxes, net of federal benefit	65	336	30
Other, net	121	(565)	(1,090)
Income tax benefit (provision)	<u>\$ (2,324)</u>	<u>\$ 11,379</u>	<u>\$ (19,290)</u>

The components of deferred tax assets and liabilities were as follows:

	As of	
	December 30, 2012	January 1, 2012
	(In thousands)	
Deferred tax assets:		
Credits and net operating loss carryovers	\$ 195,638	\$ 234,968
Reserves and accruals	71,775	55,600
Excess of book over tax depreciation	34,737	32,073
Deferred income	7,782	6,880
Total deferred tax assets	309,932	329,521
Less valuation allowance	(307,199)	(327,503)
Deferred tax assets, net	2,733	2,018
Deferred tax liabilities:		
Intangible assets arising from acquisitions	(1,072)	(2,018)
Total deferred tax liabilities	(1,072)	(2,018)
Net deferred tax assets	\$ 1,661	\$ —

The deferred tax assets and valuation allowance as at December 30, 2012, includes an adjustment of approximately \$18.9 million related to prior periods. This adjustment has no impact on the reported net deferred tax assets or liabilities. Additionally, the income tax expense for the fiscal year ended December 30, 2012, includes a benefit of approximately \$1.2 million to correct an understatement of a prior year deferred tax asset. Management believes that the impact of these errors is not material to any prior years' financial statements and the impact of correcting these errors in the current year is not material to the full year fiscal 2012 financial statements.

As of December 30, 2012, of the total deferred tax assets of \$309.9 million, a valuation allowance of \$307.2 million has been recorded for the portion which is not more likely than not to be realized. As of January 1, 2012, of the total deferred tax assets of \$329.5 million, a valuation allowance of \$327.5 million has been recorded for the portion which is not more likely than not to be realized. Our determination of the need for a valuation allowance each year is based on a jurisdictional assessment.

At December 30, 2012, we had U.S. federal net operating loss carryovers of approximately \$661.7 million, which, if not utilized, will expire from 2018 through 2032. Of the \$661.7 million, \$30.8 million relates to acquisitions and are subject to Section 382 limitation. When recognized, the tax benefit related to \$658.9 million of these net operating losses will be accounted for as an increase to additional paid-in capital rather than a reduction of the income tax provision. We had state net operating loss carryovers of approximately \$317.1 million which, if not utilized, will expire from 2013 through 2023. A portion of these net operating loss carryovers relate to prior acquisitions and are subject to certain limitations. We had U.S. federal tax credit carryforwards of approximately \$117.8 million, which, if not utilized, will expire from 2019 through 2032, and state tax credit carryforwards of approximately \$92.5 million, which currently do not have any expiration date. In addition, utilization of the net operating losses and tax credit carryovers may be limited if certain ownership changes occur subsequent to December 30, 2012.

We received tax deductions from the gains realized by employees on the exercise of certain non-qualified stock options for which the benefit is recognized as a component of stockholders' equity. Historically, we have evaluated the deferred tax assets relating to these stock option deductions along with our other deferred tax assets and concluded that a valuation allowance is required for that portion of the total deferred tax assets that cannot be considered more likely than not to be realized in future periods. To the extent that the deferred tax assets with a valuation allowance become realizable in future periods, we will have the ability, subject to carryforward limitations, to benefit from these amounts. When realized, the tax benefit of tax deductions related to stock

options are accounted for as an increase to additional paid-in capital rather than a reduction of the income tax provision.

United States income taxes and foreign withholding taxes have not been provided on a cumulative total of \$246.3 million and \$207.5 million of undistributed earnings for certain non-United States subsidiaries as of December 30, 2012 and January 1, 2012, respectively, because such earnings are intended to be indefinitely reinvested in the operations and potential acquisitions of our international operations. Upon distribution of those earnings in the form of dividends or otherwise, we would be subject to U.S. income taxes (subject to an adjustment for foreign tax credits). It is not practicable to determine the income tax liability that might be incurred if these earnings were to be distributed.

Our global operations involve manufacturing, research and development, and selling activities. Our operations outside the U.S. are in certain countries that impose a statutory tax rate both higher and lower than the U.S. We are subject to tax holidays in the Philippines where we manufacture and design certain of our products. These tax holidays are scheduled to expire at varying times within the next three years. Our tax benefit of these tax holidays for the year ended December 30, 2012 was \$0.2 million which had an insignificant impact on earnings per share. Overall, we expect our foreign earnings to be taxed at rates lower than the statutory tax rate in the U.S.

### Unrecognized Tax Benefits

The following table is a reconciliation of unrecognized tax benefits:

<u>(In thousands)</u>	
Unrecognized tax benefits, as of January 3, 2010	\$ 39,314
Increase based on tax positions related to current year	5,311
Increase based on tax positions related to prior years	3,059
Decrease related to lapsing of statutes of limitations	<u>(861)</u>
Unrecognized tax benefits, as of January 2, 2011	\$ 46,823
Decrease related to settlements with taxing authorities	(14,830)
Increase based on tax positions related to current year	6,794
Decrease based on tax positions related to prior years	(1,238)
Decrease related to lapsing of statutes of limitations	<u>(7,732)</u>
Unrecognized tax benefits, as of January 1, 2012	\$ 29,817
Decrease related to settlements with taxing authorities	(1,807)
Increase based on tax positions related to current year	5,392
Increase based on tax positions related to prior year	1,004
Decrease related to lapsing of statute of limitation	<u>(2,940)</u>
Unrecognized tax benefits, as of December 30, 2012	<u>\$ 31,466</u>

As of December 30, 2012, January 1, 2012 and January 2, 2011, the amounts of unrecognized tax benefits that, if recognized, would affect our effective tax rate totaled \$28.2 million, \$27.5 million and \$43.6 million, respectively.

Management believes events that could occur in the next 12 months and cause a material change in unrecognized tax benefits include, but are not limited to, the following:

- completion of examinations by the U.S. or foreign taxing authorities; and
- expiration of statute of limitations on our tax returns.

The calculation of unrecognized tax benefits involves dealing with uncertainties in the application of complex global tax regulations. Management regularly assesses our tax positions in light of legislative, bilateral tax treaty, regulatory and judicial developments in the countries in which we do business. We believe it is

possible that we may recognize approximately \$14.0 million to \$16.0 million of our existing unrecognized tax benefits within the next twelve months as a result of the lapse of statutes of limitations and the resolution of agreements with domestic and various foreign tax authorities.

### Classification of Interest and Penalties

Our policy is to classify interest expense and penalties, if any, as components of income tax provision in the Consolidated Statements of Operations. As of December 30, 2012, January 1, 2012 and January 2, 2011, the amount of accrued interest and penalties totaled \$11.6 million, \$9.8 million and \$10.1 million, respectively. We recorded interest and penalties of approximately \$1.8 million, \$(0.3) million and \$3.7 million during fiscal 2012, 2011 and 2010, respectively.

### Tax Examinations

The following table summarizes our major tax jurisdictions and the tax years that remain subject to examination by such jurisdictions as of December 30, 2012:

<u>Tax Jurisdictions</u>	<u>Tax Years</u>
United States	2009 and onward
Philippines	2008 and onward
India	2007 and onward
California	2007 and onward

Non-U.S. tax authorities have completed their income tax examinations of our subsidiary in India for fiscal years 2002-2006 and our subsidiary in the Philippines for 2008 and 2009. The proposed adjustments in India have been appealed, and we believe the ultimate outcome of these appeals will not result in a material adjustment to our tax liability. The Philippines examinations for 2008 and 2009 resulted in no material adjustments to our tax liabilities. Income tax examinations of our Philippine subsidiary for the 2010 fiscal year and our India subsidiary for the 2007-2008 fiscal years are in progress. We believe the ultimate outcome of these examinations will not result in a material adjustment to our tax liability.

## NOTE 18. COMMITMENTS AND CONTINGENCIES

### Product Warranties

We generally warrant our products against defects in materials and workmanship for a period of one year and that product warranty is generally limited to a refund of the original purchase price of the product or a replacement part. We estimate our warranty costs based on historical warranty claim experience. Warranty returns are recorded as an allowance for sales returns. The allowance for sales returns is reviewed quarterly to verify that it properly reflects the remaining obligations based on the anticipated returns over the balance of the obligation period.

The following table presents our warranty reserve activities:

	<u>Year Ended</u>		
	<u>December 30, 2012</u>	<u>January 1, 2012</u>	<u>January 2, 2011</u>
		(In thousands)	
Beginning balance	\$ 3,085	\$ 3,347	\$ 3,151
Provisions	1,179	2,000	5,541
Settlements made	(904)	(2,262)	(5,345)
Ending balance	<u>\$ 3,360</u>	<u>\$ 3,085</u>	<u>\$ 3,347</u>



## Patent License Agreement

On April 30, 2012, we entered into a strategic Patent License Agreement (“PLA”) with IV Global Licensing LLC (“IV”) under which we and our majority-owned subsidiaries received a license to IV’s substantial patent portfolio. This transaction allowed us and IV to continue to develop our strategic relationship regarding patent monetization and litigation defense. Under the terms of the PLA, we have agreed to pay a license fee of approximately \$14 million and to purchase certain litigation defense services from IV in the future. In addition, in a related agreement, IV is expected to make certain patent purchases from us in the near term. The exact terms and conditions of the PLA are subject to confidentiality provisions, and are the subject of an application for confidential treatment to be filed with the SEC.

One of the benefits that we received from the PLA was the avoidance of future litigation expenses as well as future customer disruption and based upon our analysis, using a relief from royalty method, we determined that a portion of the license fee that we will pay IV represents the cumulative cost relating to prior years. As such, we recorded approximately, \$7.1 million which has been recorded as a charge to cost of revenues in the first quarter of fiscal 2012. We originally capitalized approximately \$6.9 million in the Consolidated Balance Sheet and are amortizing over the purchased life of the patent portfolio. Approximately \$0.6 million was amortized as of December 30, 2012. The remaining capitalized balance of the PLA is approximately \$0.8 million in current assets, and \$5.5 million in long-term assets in the Consolidated Balance Sheet as of December 30, 2012. We paid the entire \$14.0 million liability in fiscal 2012.

## Capital Lease

On July 19, 2011, we entered into a capital lease agreement which allows us to borrow up to \$35.0 million to finance the acquisition of certain manufacturing equipment. We have the option of purchasing the tools from the lessor at specified intervals during the lease term. The master lease contains standard covenants requiring us to insure and maintain the equipment in accordance with the manufacturers’ recommendations and comply with other customary terms to protect the leased assets. In addition, the master lease agreement contains provisions in the event of default. Assets purchased under the capital lease are included in “Property, plant and equipment, net” as manufacturing equipment and the amortization is included in depreciation. As of December 30, 2012, the gross value and net book value of manufacturing equipment purchased under capital lease was approximately \$20.5 million and \$18.0 million, respectively. As of December 30, 2012, the total minimum lease payments under our capital leases amounted to approximately \$15.0 million.

Future minimum payments, by year and in the aggregate, under the capitalized lease consist of the following:

<u>Fiscal Year</u>	<u>(In thousands)</u>
2013	\$ 2,936
2014	2,936
2015	2,937
2016	6,581
2017	600
Total minimum lease payments	15,990
Less: amount representing interest	955
Present value of net minimum lease payments	<u>\$ 15,035</u>

## Charitable Donation of Building

In fiscal 2011, we sold a building to a charitable organization for \$4.0 million in exchange for a promissory note. The promissory note will be paid over the next four years in \$1.0 million annual payments and is reflected in our fiscal 2012 Consolidated Balance Sheet as “Other current assets” and “Other long-term assets”. In addition, we made a \$4.0 million unconditional pledge to the same charitable organization to be paid in four

\$1.0 million installments over the next four years. This amount is reflected in “Other current liabilities” and “Other non-current liabilities” in our fiscal 2012 Consolidated Balance Sheet.

### Operating Lease Commitments

We lease certain facilities and equipment under non-cancelable operating lease agreements that expire at various dates through fiscal 2018. Some leases include renewal options, which would permit extensions of the expiration dates at rates approximating fair market rental values.

As of December 30, 2012, future minimum lease payments under non-cancelable operating leases were as follows:

<u>Fiscal Year</u>	<u>(In thousands)</u>
2013	\$ 5,762
2014	5,236
2015	4,492
2016	3,431
2017	2,921
2018 and Thereafter	<u>739</u>
Total	<u>\$22,581</u>

Rental expenses totaled approximately \$7.7 million, \$7.0 million and \$7.2 million in fiscal 2012, 2011 and 2010, respectively.

### Litigation and Asserted Claims

In July 2011, the International Trade Commission (“ITC”) instituted a formal action to enjoin the importation of GSI Technology, Inc. (“GSI”) products that we believe infringe four of our U.S. patents. The Cypress patents at issue are asserted against GSI’s static random access memory (“SRAM”) technology, including GSI’s Sigma DDR, SigmaQuad II and SigmaQuad III families of memory products, GSI’s standard synchronous and ZBT SRAMs, as well as a proprietary product made for GSI’s largest customer. On October 25, 2012, Chief Administrative Law Judge Charles Bullock issued his initial determination, finding no violation of the Tariff Act by GSI. We immediately sought full review of the initial determination by the ITC Commission, and on December 21, 2012, the Commission remanded the case back to Judge Bullock for rulings on validity and enforceability. On February 25, 2013, Judge Bullock issued his ruling, finding all four Cypress patents valid and enforceable. The Commission will review Judge Bullock’s rulings in their entirety. The Commission’s review is scheduled to be complete by June 25, 2013. We believe strongly in the merits of our ITC action, and intend to take the steps necessary to protect our intellectual property. Our five-patent infringement case against GSI in the United States District Court for the District of Minnesota remains stayed pending a final determination in the ITC matter. We are seeking damages as well as injunctive relief in the Minnesota action.

In July 2011, GSI filed requests for re-examination of two of our asserted patents (U.S. Patent Nos. 7,142,477 and 6,534,805) with the U.S. Patent and Trademark Office (“PTO”). The PTO has completed its re-examination of U.S. Patent No. 7,142,477 and confirmed its validity, and allowed 64 new claims added during the re-examination. The re-examination of U.S. Patent No. 6,534,805 remains pending with respect to 6 of the 10 original claims; however, the PTO has confirmed the validity of three of the original claims and allowed 51 new claims added during the re-examination. The last remaining original claim was not subject to the re-examination. In July 2011, GSI also filed a civil antitrust complaint with the United States District Court for the Northern District of California, accusing the QDR Consortium, of which we are a member, of certain anti-competitive activity. We are currently engaged in the early stages of discovery in this case. Aside from injunctive relief, GSI has made no specific monetary demand in the antitrust matter. Accordingly, the possible range of monetary loss

in the matter, if any, to be demanded in the future is unknown at this time. We believe we have meritorious defenses to the allegations set forth in the GSI civil antitrust complaint and we will vigorously defend ourselves in that matter.

In February 2012, Cypress was named as a defendant in a four-patent infringement case filed by the bankruptcy trustee of the assets of Qimonda AG (“Qimonda”), a non-operating entity, in the United States District Court for the Eastern District of Virginia. The case was transferred to the Northern District of California, and subsequently dismissed without prejudice on December 19, 2012. While Qimonda does have the right to refile its complaint, it has not done so as of the date of this report. We feel strongly about our non-infringement and invalidity defenses, especially in this case. In the event Qimonda refiles its complaint, we intend to take immediate steps to bring the case to an early resolution in our favor. Because we believe we have such meritorious non-infringement and invalidity defenses in this case, we will defend ourselves vigorously. Qimonda is seeking injunctive relief as well as unspecified monetary damages. Because the case is at a very early stage and no specific monetary demand has been made, it is not possible for us to estimate the potential loss or range of potential losses.

As a result of our acquisition of Ramtron, we have assumed control of certain ongoing litigation involving Ramtron, including certain shareholder litigation related to the Ramtron acquisition. On October 15, 2012, Paul Dent (“Plaintiff Dent”), a stockholder of Ramtron, filed a complaint in the Court of Chancery in the State of Delaware, as a class action on behalf of himself and other similarly situated Ramtron stockholders. Plaintiff Dent alleges that Ramtron and certain of its directors and officers breached their fiduciary duties in connection with the merger agreement pursuant to which we agreed to acquire all of the outstanding shares of Ramtron for \$3.10 a share in cash. Specifically, the complaint alleges that Ramtron and certain of its directors and officers failed to engage in a competitive process and disclose fully all material information relating to the Board’s recommendation to Ramtron’s stockholders to tender shares to Cypress. On October 22, 2012, Plaintiff Dent added us and Cypress’s wholly-owned subsidiary Rain Acquisition Corporation as defendants to the case and petitioned the court for expedited proceedings and a preliminary injunction. On November 19, 2012, the Delaware Chancery Court ruled in our favor, denying plaintiff’s request for injunctive relief and finding there was no material information withheld from the shareholders of Ramtron. The case was effectively dismissed following the ruling. However, on January 11, 2013, Plaintiff Dent filed an amended complaint on similar grounds, with allegations also directed towards Cypress for aiding and abetting Ramtron’s directors and officers. The relief sought by the amended complaint includes an order declaring the action to be properly maintainable as a class action, an award of the fair value of the Ramtron shares plus interest, damages including rescissory damages plus interest, and an award of attorneys’ fees and costs. We believe strongly that this case is without merit and we intend to defend it vigorously and plan to promptly file a motion to dismiss. Because the case is at a very early stage and no specific monetary demand has been made, it is not possible for us to estimate the potential loss or range of potential losses.

On October 3, 2012, Allan P. Weber (“Plaintiff Weber”), a purported Ramtron stockholder, also filed a putative class action complaint against Ramtron, certain of its officers and directors, and Cypress and its wholly-owned subsidiary Rain Acquisition Corporation in Colorado state district court in El Paso County, Colorado. Plaintiff Webber alleges that the directors and officers of Ramtron breached their fiduciary duties in connection with the merger agreement, pursuant to which Cypress agreed to acquire all of the outstanding shares of Ramtron for \$3.10 per share in cash. Specifically, the complaint alleges that the officer and directors of Ramtron violated their fiduciary duties by failing to take steps to maximize the value of Ramtron to its public stockholders and took steps to avoid competitive bidding, failed to properly value Ramtron, and ignored or did not protect against conflicts of interest. The complaint accuses Cypress of aiding and abetting the Ramtron directors and officers. The relief sought by Plaintiff Webber includes an order declaring the lawsuit as a class action and certifying Plaintiff Weber as class representative and his counsel as class counsel, an injunction to prevent the merger, an order rescinding the merger or awarding Plaintiff rescissory damages in the event the merger is consummated prior to entry of the court’s final judgment, damages, profits and any special benefits obtained by defendants as a result of the alleged wrongdoing, and an award of attorneys’ fees and costs. Plaintiff Webber has taken no action since the complaint was filed and we have petitioned the court to have the case dismissed. We believe this the

lawsuit is without merit and intend to defend it vigorously. Because the case is at a very early stage and no specific monetary demand has been made, it is not possible for us to estimate the potential loss or range of potential losses.

We are currently a party to various other legal proceedings, claims, disputes and litigation arising in the ordinary course of business. Based on our own investigations, we believe the ultimate outcome of our current legal proceedings, individually and in the aggregate, will not have a material adverse effect on our financial position, results of operation or cash flows. However, because of the nature and inherent uncertainties of the litigation, should the outcome of these actions be unfavorable, our business, financial condition, results of operations or cash flows could be materially and adversely affected.

### **Indemnification Obligations**

We are a party to a variety of agreements pursuant to which we may be obligated to indemnify another party to such agreements with respect to certain matters. Typically, these obligations arise in the context of contracts we have entered into, under which we customarily agree to hold the other party harmless against losses arising from a breach of representations and covenants or terms and conditions related to such matters as the sale and/or delivery of our products, title to assets sold, certain intellectual property claims, defective products, specified environmental matters and certain income taxes. In these circumstances, payment by us is customarily conditioned on the other party making a claim pursuant to the procedures specified in the particular contract, which procedures typically allow us to challenge the other party's claims and vigorously defend ourselves and the third party against such claims. Further, our obligations under these agreements may be limited in terms of time, amount or the scope of our responsibility and in some instances, we may have recourse against third parties for certain payments made under these agreements.

It is not possible to predict the maximum potential amount of future payments under these agreements due to the conditional nature of our obligations and the unique facts and circumstances involved in each particular agreement. Historically, payments we have made under these agreements have not had a material effect on our business, financial condition or results of operations. We believe that if we were to incur a loss in any of these matters, such loss would not have a material effect on our business, financial condition, cash flows or results of operations, although there can be no assurance of this. As of December 30, 2012, we had no reason to believe a loss exceeding amounts already recognized had been incurred.

## NOTE 19. SEGMENT, GEOGRAPHICAL AND CUSTOMER INFORMATION

### Segment Information

We design, develop, manufacture and market a broad range of programmable system solutions for various markets including consumer, computation, data communications, automotive and industrial. We evaluate our reportable business segments in accordance with the accounting guidance. We operate in the following four reportable business segments:

Business Segments	Description
<b>PSD:</b> Programmable Systems Division	A division focusing primarily on our PSoC <sup>®</sup> and PSoC-based products. This business segment focuses on (1) the PSoC platform family of devices including PSoC 1, PSoC 3 and PSoC 5 and all derivatives; (2) PSoC-based user interface products such as CapSense <sup>®</sup> touch-sensing and TrueTouch touchscreen products; (3) PSoC-based module solutions including Trackpad and Ovation <sup>™</sup> Optical Navigation Sensors (ONS); (4) automotive products; and (5) certain legacy product lines.
<b>MPD:</b> Memory Products Division	A division that will continue to focus on our SRAM, FRAM and non-volatile business units and general-purpose programmable clocks.
<b>DCD:</b> Data Communications Division	A division realigned to focus solely on USB controllers, WirelessUSB <sup>™</sup> and West Bridge <sup>®</sup> peripheral controllers for handsets, personal computers and tablets.
<b>ETD:</b> Emerging Technologies Division	Our “startup” division, which includes, AgigA Tech Inc. and Deca Technologies Inc., all majority-owned subsidiaries of Cypress. ETD also includes our foundry business and other development-stage activities.

The following tables set forth certain information relating to the reportable business segments:

#### Revenues:

	Year Ended		
	December 30, 2012	January 1, 2012	January 2, 2011
	(In thousands)		
Programmable Systems Division	\$ 356,389	\$ 482,895	\$ 280,615
Memory Products Division	330,504	394,832	467,422
Data Communications Division	75,632	112,683	127,020
Emerging Technologies and Other	7,162	4,794	2,475
Total revenues	\$ 769,687	\$ 995,204	\$ 877,532

Income (Loss) from Operations before Income Taxes:

	Year Ended		
	December 30, 2012	January 1, 2012	January 2, 2011
	(In thousands)		
Programmable Systems Division	\$ (2,867)	\$ 91,640	\$ 16,955
Memory Products Division	124,275	154,592	175,267
Data Communications Division	(4,371)	13,239	20,695
Emerging Technologies and Other	(23,375)	(19,883)	(17,756)
Unallocated items:			
Stock-based compensation expense	(74,332)	(100,781)	(91,459)
Gain (loss) on divestitures and expenses	(3,351)	34,291	—
Patent license fee	(7,100)	—	—
Restructuring charges	(4,258)	(6,336)	(2,975)
Charitable donation of building	—	(4,125)	—
Amortization of intangibles and other acquisition-related costs	(19,337)	(2,892)	(3,028)
Impairment of assets and other	(3,758)	(2,782)	(4,927)
Other	(2,253)	(1,385)	1,394
Non-cash compensation	(933)	—	—
Income (loss) from operations before income taxes	<u>\$ (21,660)</u>	<u>\$ 155,578</u>	<u>\$ 94,166</u>

Depreciation:

	Year Ended		
	December 30, 2012	January 1, 2012	January 2, 2011
	(In thousands)		
Programmable Systems Division	\$ 18,601	\$ 23,497	\$ 15,509
Memory Products Division	18,265	19,199	25,345
Data Communications Division	4,192	5,564	6,829
Emerging Technologies and Other	4,483	373	176
Total depreciation	<u>\$ 45,541</u>	<u>\$ 48,633</u>	<u>\$ 47,859</u>

**Geographical Information**

The following table presents our total revenues by geographical locations:

	Year Ended		
	December 30, 2012	January 1, 2012	January 2, 2011
	(In thousands)		
United States	\$ 101,674	\$ 122,956	\$ 142,239
Europe	78,216	118,695	134,117
Asia:			
China	334,113	427,794	345,416
South Korea	94,672	136,777	36,549
Japan	67,270	70,279	78,012
Rest of the world	93,742	118,703	141,199
Total revenues	<u>\$ 769,687</u>	<u>\$ 995,204</u>	<u>\$ 877,532</u>

Property, plant and equipment, net, by geographic locations were as follows:

	As of	
	December 30, 2012	January 1, 2012
	(In thousands)	
United States	\$ 180,139	\$ 187,438
Philippines	73,091	75,323
Other	21,197	22,218
Total property, plant and equipment, net	<u>\$ 274,427</u>	<u>\$ 284,979</u>

We track our assets by physical location. Although management reviews asset information on a corporate level and allocates depreciation expense by segment, our chief operating decision maker does not review asset information on a segment basis.

### Customer Information

Outstanding accounts receivable from three of our distributors, accounted for 12.2%, 11.9% and 10.2%, respectively, of our consolidated accounts receivable as of December 30, 2012. Outstanding accounts receivable from three of our distributors, accounted for 14.1%, 13.9% and 11.1%, respectively, of our consolidated accounts receivable as of January 1, 2012.

Revenue generated through three of our distributors, accounted for 13.5%, 12.4% and 10.1% respectively, of our consolidated revenue for fiscal 2012. One end customer, purchases our products from certain of our distributors. Shipments to this end customer accounted for 10.8% of our consolidated revenue for fiscal 2012.

Revenue generated through two of our distributors accounted for 12.8% and 11.2%, respectively, of our consolidated revenue for fiscal 2011. Shipments to one end customer accounted for 10.0% of our consolidated revenue for fiscal 2011.

Revenue through two of our distributors accounted for 15% and 10%, respectively, of our consolidated revenue for fiscal 2010. We had no end customers accounting for 10% or greater of our consolidated revenue for fiscal 2010.

### NOTE 20. SUBSEQUENT EVENTS

Subsequent to our fiscal year end, a privately-held company in which we held an investment in at a carrying value of \$1.2 million, offered another round of financing which effectively diluted our initial investment. Based on this new round of financing, we determined that our investment was impaired and wrote off the entire \$1.2 million investment amount. The impairment expense was recorded in "Other income / expense" on the Consolidated Statement of Operations.

## Report of Independent Registered Public Accounting Firm

To the Board of Directors and Stockholders of Cypress Semiconductor Corporation:

In our opinion, the consolidated financial statements listed in the index appearing under Item 15(a)(1) present fairly, in all material respects, the financial position of Cypress Semiconductor Corporation and its subsidiaries (the “Company”) at December 30, 2012 and January 1, 2012 and the results of their operations and their cash flows for each of the three years in the period ended December 30, 2012 in conformity with accounting principles generally accepted in the United States of America. In addition, in our opinion, the financial statement schedule listed in the index appearing under Item 15(a)(2) presents fairly, in all material respects, the information set forth therein when read in conjunction with the related consolidated financial statements. Also in our opinion, the Company maintained, in all material respects, effective internal control over financial reporting as of December 30, 2012, based on criteria established in *Internal Control—Integrated Framework* issued by the Committee of Sponsoring Organizations of the Treadway Commission (COSO). The Company’s management is responsible for these financial statements and financial statement schedule, for maintaining effective internal control over financial reporting and for its assessment of the effectiveness of internal control over financial reporting, included in the accompanying Management’s Report on Internal Control over Financial Reporting appearing under Item 9A. Our responsibility is to express opinions on these financial statements, on the financial statement schedule, and on the Company’s internal control over financial reporting based on our integrated audits. We conducted our audits in accordance with the standards of the Public Company Accounting Oversight Board (United States). Those standards require that we plan and perform the audits to obtain reasonable assurance about whether the financial statements are free of material misstatement and whether effective internal control over financial reporting was maintained in all material respects. Our audits of the financial statements included examining, on a test basis, evidence supporting the amounts and disclosures in the financial statements, assessing the accounting principles used and significant estimates made by management, and evaluating the overall financial statement presentation. Our audit of internal control over financial reporting included obtaining an understanding of internal control over financial reporting, assessing the risk that a material weakness exists, and testing and evaluating the design and operating effectiveness of internal control based on the assessed risk. Our audits also included performing such other procedures as we considered necessary in the circumstances. We believe that our audits provide a reasonable basis for our opinions.

A company’s internal control over financial reporting is a process designed to provide reasonable assurance regarding the reliability of financial reporting and the preparation of financial statements for external purposes in accordance with generally accepted accounting principles. A company’s internal control over financial reporting includes those policies and procedures that (i) pertain to the maintenance of records that, in reasonable detail, accurately and fairly reflect the transactions and dispositions of the assets of the company; (ii) provide reasonable assurance that transactions are recorded as necessary to permit preparation of financial statements in accordance with generally accepted accounting principles, and that receipts and expenditures of the company are being made only in accordance with authorizations of management and directors of the company; and (iii) provide reasonable assurance regarding prevention or timely detection of unauthorized acquisition, use, or disposition of the company’s assets that could have a material effect on the financial statements.

Because of its inherent limitations, internal control over financial reporting may not prevent or detect misstatements. Also, projections of any evaluation of effectiveness to future periods are subject to the risk that controls may become inadequate because of changes in conditions, or that the degree of compliance with the policies or procedures may deteriorate.

As described in Management’s Report on Internal Control over Financial Reporting appearing under Item 9A, management has excluded Ramtron International Corporation from its assessment of internal control over financial reporting as of December 30, 2012 because it was acquired by the Company in a business combination during the fourth quarter of fiscal 2012. We have also excluded Ramtron International Corporation



from our audit of internal control over financial reporting. Ramtron International Corporation is a wholly-owned subsidiary of the Company whose total assets and net revenues represent less than 3% and less than 1%, respectively, of the related consolidated financial statement amounts as of, and for the year ended, December 30, 2012.

/s/ PricewaterhouseCoopers LLP

San Jose, California

February 28, 2013

## UNAUDITED QUARTERLY FINANCIAL DATA

### *Fiscal 2012*

	Three Months Ended			
	December 30, 2012 (1)	September 30, 2012 (2)	July 1, 2012	April 1, 2012
	(In thousands, except per-share amounts)			
Revenues	\$ 180,283	\$ 203,015	\$ 201,300	\$ 185,089
Gross margin	\$ 84,194	\$ 110,056	\$ 106,769	\$ 91,781
Net income (loss)	\$ (22,803)	\$ 13,958	\$ 4,632	\$ (19,771)
Adjust for net loss attributable to noncontrolling interest	584	374	345	311
Net income (loss) attributable to Cypress	<u>\$ (22,219)</u>	<u>\$ 14,332</u>	<u>\$ 4,977</u>	<u>\$ (19,460)</u>
Net income (loss) per share—basic	<u>\$ (0.15)</u>	<u>\$ 0.10</u>	<u>\$ 0.03</u>	<u>\$ (0.13)</u>
Net income (loss) per share—diluted	<u>\$ (0.15)</u>	<u>\$ 0.09</u>	<u>\$ 0.03</u>	<u>\$ (0.13)</u>

### *Fiscal 2011*

	Three Months Ended			
	January 1, 2012	October 2, 2011	July 3, 2011	April 3, 2011
	(In thousands, except per-share amounts)			
Revenues	\$ 242,373	\$ 264,743	\$ 254,978	\$ 233,110
Gross margin	\$ 129,852	\$ 148,954	\$ 139,020	\$ 128,776
Net income	\$ 31,382	\$ 39,743	\$ 40,642	\$ 55,190
Adjust for net loss attributable to noncontrolling interest	279	238	181	184
Net income attributable to Cypress	<u>\$ 31,661</u>	<u>\$ 39,981</u>	<u>\$ 40,823</u>	<u>\$ 55,374</u>
Net income per share—basic	<u>\$ 0.21</u>	<u>\$ 0.24</u>	<u>\$ 0.24</u>	<u>\$ 0.32</u>
Net income per share—diluted	<u>\$ 0.18</u>	<u>\$ 0.22</u>	<u>\$ 0.21</u>	<u>\$ 0.28</u>

- (1) The results for the three months ended December 30, 2012 included approximately \$15.3 of non-recurring costs incurred in connection with the acquisition of Ramtron, and a tax benefit of approximately \$1.2 million that related to prior periods.
- (2) The results for the three months ended September 30, 2012 included approximately \$1.5 million of inventory-related charges that related to prior periods

Basic and diluted earnings per share are computed independently for each of the quarters presented. Therefore, the sum of quarterly basic and diluted per share information may not equal annual basic and diluted earnings per share.

### **ITEM 9. CHANGES IN AND DISAGREEMENTS WITH ACCOUNTANTS ON ACCOUNTING AND FINANCIAL DISCLOSURES**

None.

### **ITEM 9A. CONTROLS AND PROCEDURES**

#### **Evaluation of Disclosure Controls and Procedures**

We maintain “disclosure controls and procedures,” as such term is defined in Rules 13a-15(e) and 15d-15(e) under the Securities Exchange Act of 1934, as amended (the “Exchange Act”), that are designed to ensure that information required to be disclosed by us in reports that we file or submit under the Exchange Act is recorded,

processed, summarized, and reported within the time periods specified in Securities and Exchange Commission rules and forms, and that such information is accumulated and communicated to our management, including our Chief Executive Officer and Chief Financial Officer, as appropriate, to allow timely decisions regarding required disclosure. In designing and evaluating our disclosure controls and procedures, management recognized that disclosure controls and procedures, no matter how well conceived and operated, can provide only reasonable, not absolute, assurance that the objectives of the disclosure controls and procedures are met. Additionally, in designing disclosure controls and procedures, our management necessarily was required to apply its judgment in evaluating the cost-benefit relationship of possible disclosure controls and procedures. The design of any disclosure controls and procedures also is based in part upon certain assumptions about the likelihood of future events, and there can be no assurance that any design will succeed in achieving its stated goals under all potential future conditions.

Based on their evaluation as of the end of the period covered by this Annual Report on Form 10-K and subject to the foregoing, our Chief Executive Officer and Chief Financial Officer have concluded that our disclosure controls and procedures were effective at the reasonable assurance level.

### **Management's Report on Internal Control over Financial Reporting**

Our management is responsible for establishing and maintaining adequate internal control over financial reporting as defined in Rule 13a-15(f) of the Exchange Act. Because of its inherent limitations, internal control over financial reporting may not prevent or detect misstatements and can only provide reasonable assurance with respect to financial statement preparation. Also, projections of any evaluation of effectiveness to future periods are subject to the risk that controls may become inadequate because of changes in conditions, or that the degree of compliance with the policies or procedures may deteriorate.

We assessed the effectiveness of our internal control over financial reporting as of December 30, 2012. In making this assessment, we used the criteria set forth by the Committee of Sponsoring Organizations of the Treadway Commission ("COSO") in *Internal Control—Integrated Framework*. Based on our assessment using those criteria, our management (including our Chief Executive Officer and Chief Financial Officer) concluded that our internal control over financial reporting was effective as of December 30, 2012.

We excluded Ramtron International Corporation from our assessment of the effectiveness of our internal control over financial reporting as of December 30, 2012 because it was acquired by us in a business combination during the fourth quarter of 2012. Ramtron International Corporation, our wholly owned subsidiary, constituted less than 3% of total assets and less than 1% of net revenues of the related amounts reported in our consolidated financial statements for the year ended December 30, 2012.

Our independent registered public accounting firm, PricewaterhouseCoopers LLP, has issued a report on our internal control over financial reporting. The report on the audit of internal control over financial reporting appears on page 107 of this Annual Report on Form 10-K.

### **Changes in Internal Control over Financial Reporting**

There were no changes in our internal control over financial reporting that occurred during the fourth quarter of fiscal 2012 that have materially affected, or are reasonably likely to materially affect, our internal control over financial reporting.

### **ITEM 9B. OTHER INFORMATION**

None.

### PART III

Certain information required by Part III is omitted from this Annual Report on Form 10-K. We will file a definitive proxy statement pursuant to Regulation 14A (the "Proxy Statement") not later than 120 days after the end of the fiscal year covered by this Annual Report on Form 10-K, and certain information included therein is incorporated herein by reference.

#### ITEM 10. DIRECTORS, EXECUTIVE OFFICERS AND CORPORATE GOVERNANCE

The information required by this item will be included under the caption "Directors, Executive Officers and Corporate Governance" in our Proxy Statement for the 2013 Annual Meeting of Stockholders to be filed with the SEC within 120 days of the fiscal year ended December 30, 2012 (2013 Proxy Statement) and is incorporated herein by reference. The information required by this item regarding delinquent filers pursuant to Item 405 of Regulation S-K will be included under the caption "Section 16(a) Beneficial Ownership Reporting Compliance" in the 2013 Proxy Statement and is incorporated herein by reference.

We have adopted a code of ethics that applies to all of our directors, officers and employees. We have made the code of ethics available, free of charge, on our website at [www.cypress.com](http://www.cypress.com).

#### ITEM 11. EXECUTIVE COMPENSATION

The information required by this item concerning executive compensation is incorporated by reference from the information set forth in the section titled "Executive Compensation" in our 2013 Proxy Statement and is incorporated herein by reference.

The information required by this item concerning compensation of directors is incorporated by reference from the information set forth in the section titled "Board Structure and Compensation" in our 2013 Proxy Statement and is incorporated herein by reference.

The information required by this item concerning our compensation committee is incorporated by reference from the information set forth in the sections titled "Compensation Committee Interlocks and Insider Participation" and "Report of the Compensation Committee of the Board of Directors" in our 2013 Proxy Statement and is incorporated herein by reference.

#### Quarterly Executive Incentive Payments

There were no performance incentive payments earned by our executive officers in accordance with the terms of our Key Employee Bonus Plan (the "KEBP") and the Performance Bonus Plan (the "PBP") for the fourth quarter and the annual portion of fiscal 2012.

#### Release of 2012 PARS

On December 27, 2012, the Committee approved the performance milestone achievements for fiscal 2012. In connection with the Committee's determination of the achievement of fiscal 2012 PARS performance milestones, the following shares, prior to tax payments, were released to our Named Executive Officers:

<u>Named Executive Officer</u>	<u>Target</u>	<u>Total Shares Released</u>
T.J. Rodgers, President and Chief Executive Officer	576,831	168,022
Brad W. Buss, Executive Vice President, Finance and Administration and Chief Financial Officer	360,519	105,013
Paul Keswick, Executive Vice President, New Product Development	288,416	84,011
Christopher Seams, Executive Vice President, Sales and Marketing	288,416	84,011
Dana Nazarian, Division Executive Vice President	250,164	72,869

**ITEM 12. SECURITY OWNERSHIP OF CERTAIN BENEFICIAL OWNERS AND MANAGEMENT AND RELATED STOCKHOLDER MATTERS**

The information required by this item regarding security ownership of certain beneficial owners, directors and executive officers is incorporated by reference from the information set forth in the section titled “Security Ownership of Certain Beneficial Owners and Management” in our 2013 Proxy Statement.

The information required by this item regarding our equity compensation plans is incorporated by reference from Item 5 of this Annual Report on Form 10-K.

**ITEM 13. CERTAIN RELATIONSHIPS AND RELATED TRANSACTIONS AND DIRECTOR INDEPENDENCE**

The information required by this item regarding transactions with certain persons is incorporated by reference from the information set forth in the section titled “Certain Relationships and Related Transactions” in our 2013 Proxy Statement.

The information required by this item regarding director independence is incorporated by reference from the information set forth in the section titled “Board Structure and Compensation” in our Proxy Statement.

**ITEM 14. PRINCIPAL ACCOUNTANT FEES AND SERVICES**

The information required by this item regarding fees and services is incorporated by reference from the information set forth in the section titled “Proposal Two—Ratification of the Selection of Independent Registered Public Accounting Firm” in our Proxy Statement.

The information required by this item regarding the audit committee’s pre-approval policies and procedures is incorporated by reference from the information set forth in the section titled “Report of the Audit Committee of the Board of Directors” in our Proxy Statement.

## PART IV

### ITEM 15. EXHIBITS AND FINANCIAL STATEMENT SCHEDULE

(a) The following documents are filed as a part of this Annual Report on Form 10-K:

1. Financial Statements:

	<u>Page</u>
Consolidated Balance Sheets	58
Consolidated Statements of Operations	59
Consolidated Statements of Stockholders' Equity	61
Consolidated Statements of Cash Flows	63
Notes to Consolidated Financial Statements	65

2. Financial Statement Schedule:

	<u>Page</u>
Schedule II—Valuation and Qualifying Accounts	117

All other schedules are omitted as the required information is inapplicable or the information is presented in the Consolidated Financial Statements or Notes to Consolidated Financial Statements under Item 8.

3. Exhibits:

<u>Exhibit Number</u>	<u>Exhibit Description</u>	<u>Incorporated by References</u>		
		<u>Form</u>	<u>Filing Date/ Period End Date</u>	<u>Filed Herewith</u>
2.1	Agreement and Plan of Reorganization dated as of January 16, 2001 by and among Cypress Semiconductor Corporation, Clock Acquisition Corporation, International Microcircuits, Inc. and with respect to Article VII, U.S. Bank Trust, N.A., as Escrow Agent, and Kurt R. Jagers, as Securityholder Agent.	10-Q	4/1/2001	
2.2	Agreement and Plan of Reorganization dated as of January 26, 2001 by and among Cypress Semiconductor Corporation, Hilo Acquisition Corporation, HiB and Semiconductors, Inc., certain shareholder parties thereto, and U.S. Bank Trust, National Association, as Escrow Agent.	10-Q	4/1/2001	
2.3	Stock Purchase Agreement dated as of May 29, 2001 by and among Cypress Semiconductor Corporation, ScanLogic Holding Company, ScanLogic Corporation, certain shareholder parties thereto, and with respect to Article VII, U.S. Bank Trust, N.A., as Escrow Agent, and Israel Zilberman, as Securityholder Agent.	10-Q	7/1/2001	
2.4	Agreement and Plan of Reorganization dated as of June 2, 2001 by and among Cypress Semiconductor Corporation, Lion Acquisition Corporation, Lara Networks, Inc., U.S. Bank Trust National Association, as Escrow Agent (with respect to Article VII only), and Kenneth P. Lawler, as Securityholder Agent (with respect to Articles I and VII only).	10-Q	9/30/2001	
2.5	First Amendment to Agreement and Plan of Reorganization dated as of July 3, 2001 by and among Cypress Semiconductor Corporation, Lion Acquisition Corporation, Lara Networks, Inc., U.S. Bank Trust, N.A., as Escrow Agent, and Kenneth P. Lawler, as Securityholder Agent.	10-Q	9/30/2001	
2.6	Agreement and Plan of Reorganization dated as of August 19, 2001 by and among Cypress Semiconductor Corporation, In-System Design, Inc., and with respect to Article VII, U.S. Bank Trust, N.A., as Escrow Agent, and Lynn Watson, as Securityholder Agent.	10-Q	9/30/2001	
2.7	First Amendment to Agreement and Plan of Reorganization dated as of September 10, 2001 by and among Cypress Semiconductor Corporation, Idaho Acquisition Corporation, In-System Design, Inc., U.S. Bank Trust, N.A., as Escrow Agent, and Lynn Watson, as Securityholder Agent.	10-Q	9/30/2001	
2.8	Agreement and Plan of Reorganization dated as of November 17, 2001 by and among Cypress Semiconductor Corporation, Steelers Acquisition Corporation, Silicon Packets, Inc., and with respect to Article VII only, U.S. Bank Trust, N.A., as Escrow Agent, and Robert C. Marshall, as Securityholder Agent.	10-K	12/30/2001	

Exhibit Number	Exhibit Description	Incorporated by References		
		Form	Filing Date/ Period End Date	Filed Herewith
2.9	Stock Purchase Agreement dated as of June 21, 2004 by and among Cypress Semiconductor Corporation, in the name and on behalf of Cypress Semiconductor (Belgium) BVBA in Formation, FillFactory NV, certain stockholders of FillFactory NV and with respect to Article VIII and Article X only, U.S. Bank, National Association, as Escrow Agent, and Luc De Mey and IT-Partners NV, as Stockholder Agents.	8-K	8/13/2004	
2.10	Agreement and Plan of Reorganization dated as of June 30, 2004 by and among Cypress Semiconductor Corporation, SP Acquisition Corporation and SunPower Corporation.	10-K	1/2/2005	
2.11	Agreement and Plan of Merger dated as of February 11, 2005 by and among Cypress Semiconductor Corporation, SMaL Camera Technologies, Inc., Summer Acquisition Corporation, and with respect to Articles VII and IX only, U.S. Bank, National Association, as Escrow Agent, and Allan Thygesen, as Securityholder Agent.	8-K	2/15/2005	
2.12	Agreement and Plan of Merger dated November 7, 2005 by and between Cypress Semiconductor Corporation, CMS Acquisition Corporation and Cypress Microsystems, Inc.	8-K	12/8/2005	
2.13	Agreement for the Purchase and Sale of Assets and Amendment No. 1 dated as of February 15, 2006 by and between Cypress Semiconductor Corporation and NetLogic Microsystems, Inc.	8-K	2/21/2006	
2.14	Asset Purchase Agreement, dated February 27, 2007, by and between Sensata Technologies, Inc. and Cypress Semiconductor Corporation.	8-K	3/20/2007	
2.15	Agreement for the Purchase and Sale of Assets, dated August 29, 2007, by and between NetLogic Microsystems, Inc. and Cypress Semiconductor Corporation.	8-K	9/5/2007	
2.16	Agreement and Plan of Merger, dated as of August 1, 2008, by and among Cypress Semiconductor Corporation, Copper Acquisition Corporation and Simtek Corporation.	8-K	8/1/2008	
3.1	Second Restated Certificate of Incorporation of Cypress Semiconductor Corporation.	10-K	12/31/2000	
3.2	Amended and Restated Bylaws of Cypress Semiconductor Corporation.	8-K	3/31/2006	
3.3	Certificate of Amendment to Amended and Restated Bylaws of Cypress Semiconductor Corporation	8-K	5/28/2009	
3.4	Certificate of Amendment to Amended and Restated Bylaws of Cypress Semiconductor Corporation	8-K	5/18/2010	
4.1	Subordinated Indenture dated as of January 15, 2000 between Cypress Semiconductor Corporation and State Street Bank and Trust Company of California, N.A., as Trustee.	8-K	3/17/2000	
4.2	Supplemental Trust Indenture dated as of June 15, 2000 between Cypress Semiconductor Corporation and State Street Bank and Trust Company of California, N.A., as Trustee.	8-K	7/11/2000	
4.3	Indenture dated as of June 3, 2003 between Cypress Semiconductor Corporation and U.S. Bank National Association, as Trustee.	S-3	6/30/2003	
4.4	Indenture dated as of March 13, 2007 between Cypress Semiconductor Corporation and U.S. Bank National Association, as Trustee.	S-3	5/17/2007	
4.5	Registration Rights Agreement—1.00% Convertible Senior Notes due September 15, 2009.	10-Q	7/1/2007	
10.1	Form of Indemnification Agreement.	S-1	3/4/1987	
10.2	Cypress Semiconductor Corporation Non-Qualified Deferred Compensation Plan I.	S-8	9/6/2002	
10.3	Cypress Semiconductor Corporation Non-Qualified Deferred Compensation Plan II.	S-8	9/6/2002	
10.4	Lease Agreement dated as of June 27, 2003 between Wachovia Development Corporation and Cypress Semiconductor Corporation.	10-Q	6/29/2003	
10.5	Participation Agreement dated as of June 27, 2003 by and among Cypress Semiconductor Corporation, Wachovia Development Corporation and Wachovia Bank, National Association.	10-Q	6/29/2003	
10.6	Call Spread Option Confirmation dated May 29, 2003 among Cypress Semiconductor Corporation, Credit Suisse First Boston International, and Credit Suisse First Boston.	10-Q	6/29/2003	
10.7	Amended and Restated Call Spread Option Confirmation dated as of May 11, 2004 among Cypress Semiconductor Corporation, Credit Suisse First Boston International, and Credit Suisse First Boston.	10-Q	6/27/2004	
10.8	SMaL Camera Technologies, Inc. 2000 Stock Option and Incentive Plan.	S-8	3/8/2005	
10.9	First Amendment to Certain Operative Agreements dated March 28, 2005 between Wachovia Development Corporation and Cypress Semiconductor Corporation.	10-Q	4/3/2005	
10.10	Cypress Semiconductor Corporation 2006 Key Employee Bonus Plan (KEBP) Summary.	10-K	1/1/2006	
10.11	Cypress Semiconductor Corporation Performance Profit Sharing Plan (PPSP) Summary.	10-K	1/1/2006	
10.12	Memorandum of Agreement between GNPowder Ltd. Co. and Cypress Manufacturing Ltd.	10-Q	10/1/2006	

Exhibit Number	Exhibit Description	Incorporated by References		
		Form	Filing Date/ Period End Date	Filed Herewith
10.13	Letter of Agreement between Cypress Semiconductor Corporation and SunPower Corporation.	8-K	11/16/2006	
10.14	Letter of Agreement between Cypress Semiconductor Corporation and PowerLight Corporation.	8-K	11/16/2006	
10.15	Amended Letter of Agreement between Cypress Semiconductor Corporation and PowerLight Corporation.	8-K	1/5/2007	
10.16	Guaranty dated December 12, 2006 by and between Grace Semiconductor USA, Inc., CIT Technologies Corporation and Cypress Semiconductor Corporation.	10-K	12/31/2006	
10.17	Guaranty dated February 1, 2007 by and between Grace Semiconductor USA, Inc., CIT Technologies Corporation and Cypress Semiconductor Corporation.	10-K	12/31/2006	
10.18	Guaranty dated March 19, 2007 by and between Grace Semiconductor USA, Inc., CIT Technologies Corporation and Cypress Semiconductor Corporation.	10-Q	4/1/2007	
10.19	Guaranty dated May 15, 2007 by and between Grace Semiconductor USA, Inc., CIT Technologies Corporation and Cypress Semiconductor Corporation.	10-Q	7/1/2007	
10.20	Guaranty dated June 15, 2007 by and between Grace Semiconductor USA, Inc., CIT Technologies Corporation and Cypress Semiconductor Corporation.	10-Q	7/1/2007	
10.21	Guaranty dated December 15, 2007 by and between Grace Semiconductor USA, Inc., CIT Technologies Corporation and Cypress Semiconductor Corporation.	10-K	12/30/2007	
10.22	Guaranty, dated March 24, 2008, by and between Grace Semiconductor USA, Inc., CIT Technologies Corporation and Cypress Semiconductor Corporation.	10-Q	3/30/2008	
10.23	Form of Transaction Support Agreement by and among Cypress Semiconductor Corporation, Copper Acquisition Corporation and the individuals listed on the signatures pages thereto, dated as of August 1, 2008.	8-K	8/1/2008	
10.24	Amendment No. 1 to Tax Sharing Agreement, dated as of August 12, 2008, by and between Cypress Semiconductor Corporation and SunPower Corporation.	8-K	8/11/2008	
10.25	1999 Non-Statutory Stock Option Plan, as amended and restated.	S-8	10/24/2008	
10.26	Employee Qualified Stock Purchase Plan, as amended and restated.	S-8	10/24/2008	
10.27	International Microcircuits Inc. 2000 Nonstatutory Stock Option Plan.	S-8	10/24/2008	
10.28	Amended and Restated Loan and Security Agreement with Silicon Valley Bank dated March 2, 2009	10-Q	3/29/2009	
10.29	Amendment No. 1 to Amended and Restated Loan and Security Agreement with Silicon Valley Bank dated March 1, 2010.	10-K	3/3/2010	
10.30	1994 Stock Plan, as amended and Restated	8-K	6/2/2011	
10.31	Amended and Restated Loan and Security Agreement.	10-Q	5/9/2012	
10.32	2012 Incentive Award Plan, as amended and restated.	S-8	12/12/2012	
21.1	Subsidiaries of Cypress Semiconductor Corporation.	10-K	2/28/2013	X
23.1	Consent of Independent Registered Public Accounting Firm.	10-K	2/28/2013	X
24.1	Power of Attorney (reference is made to the signature page of this Annual Report on Form 10-K).	10-K	2/27/2013	X
31.1	Certification of Chief Executive Officer Pursuant to Section 302 of the Sarbanes-Oxley Act of 2002.	10-K	2/28/2013	X
31.2	Certification of Chief Financial Officer Pursuant to Section 302 of the Sarbanes-Oxley Act of 2002.	10-K	2/28/2013	X
32.1	Certification of Chief Executive Officer Pursuant to 18 U.S.C. Section 1350, as Adopted Pursuant to Section 906 of the Sarbanes-Oxley Act of 2002.	10-K	2/28/2013	X
32.2	Certification of Chief Financial Officer Pursuant to 18 U.S.C. Section 1350, as Adopted Pursuant to Section 906 of the Sarbanes-Oxley Act of 2002.	10-K	2/28/2013	X
101.INS*	XBRL Instance Document.			
101.SCH*	XBRL Taxonomy Extension Schema Document.			
101.CAL*	XBRL Taxonomy Extension Calculation Linkbase Document.			
101.DEF*	XBRL Taxonomy Extension Definition Linkbase Document.			
101.LAB*	XBRL Taxonomy Extension Label Linkbase Document.			
101.PRE*	XBRL Taxonomy Extension Presentation Linkbase Document.			

\* XBRL (Extensible Business Reporting Language) information is furnished and not filed or a part of a registration statement or prospectus for purposes of sections 11 or 12 of the Securities Act of 1933, is deemed not filed for purposes of section 18 of the Securities Exchange Act of 1934, and otherwise is not subject to liability under these sections.



**SCHEDULE II**  
**VALUATION AND QUALIFYING ACCOUNTS**

	<u>Balance at Beginning of Period</u>	<u>Charges (Releases) to Expenses/Revenues</u>	<u>Deductions</u>	<u>Balance at End of Period</u>
	(In thousands)			
Allowance for doubtful accounts receivable:				
Year ended December 30, 2012	\$ 824	\$ 571	\$ (626)	\$ 769
Year ended January 1, 2012	\$ 803	\$ 24	\$ (3)	\$ 824
Year ended January 2, 2011	\$ 1,358	\$ 60	\$ (615)	\$ 803

## SIGNATURES

Pursuant to the requirements of Section 13 or 15(d) of the Securities Exchange Act of 1934, the registrant has duly caused this report to be signed on its behalf by the undersigned, thereto duly authorized.

### CYPRESS SEMICONDUCTOR CORPORATION

Dated: February 27, 2013

By: \_\_\_\_\_ /s/ BRAD W. BUSS  
**Brad W. Buss**  
Executive Vice President, Finance and Administration and  
Chief Financial Officer

## POWER OF ATTORNEY

KNOW ALL PERSONS BY THESE PRESENTS, that each person whose signature appears below constitutes and appoints T.J. Rodgers and Brad W. Buss, jointly and severally, his attorneys-in-fact, each with the power of substitution, for him in any and all capacities, to sign any amendments to this report, and to file the same, with exhibits thereto and other documents in connection therewith, with the Securities and Exchange Commission, hereby ratifying and confirming all that each of said attorneys-in-fact, or his substitute or substitutes, may do or cause to be done by virtue hereof.

Pursuant to the requirements of the Securities Exchange Act of 1934, this report has been signed by the following persons on behalf of the registrant and in the capacities and on the dates indicated.

<u>Signature</u>	<u>Title</u>	<u>Date</u>
<u>/s/ T. J. RODGERS</u> <b>T. J. Rodgers</b>	President, Chief Executive Officer and Director (Principal Executive Officer)	February 27, 2013
<u>/s/ BRAD W. BUSS</u> <b>Brad W. Buss</b>	Executive Vice President, Finance and Administration and Chief Financial Officer (Principal Financial and Accounting Officer)	February 27, 2013
<u>/s/ W. STEVE ALBRECHT</u> <b>W. Steve Albrecht</b>	Director	February 27, 2013
<u>/s/ ERIC A. BENHAMOU</u> <b>Eric A. Benhamou</b>	Director	February 27, 2013
<u>/s/ LLOYD A. CARNEY</u> <b>Lloyd A. Carney</b>	Director	February 27, 2013
<u>/s/ JAMES R. LONG</u> <b>James R. Long</b>	Director	February 27, 2013
<u>/s/ J. DANIEL McCRANIE</u> <b>J. Daniel McCranie</b>	Director	February 27, 2013
<u>/s/ J.D. SHERMAN</u> <b>J.D. Sherman</b>	Director	February 27, 2013
<u>/s/ WILBERT G.M. VAN DEN HOEK</u> <b>Wilbert G.M. Van Den Hoek</b>	Director	February 27, 2013

**Exhibit 21.1****SUBSIDIARIES OF CYPRESS SEMICONDUCTOR CORPORATION**

<u>Name</u>	<u>Jurisdiction of Incorporation</u>
AgigA Tech (Chengdu) LLC	China
AgigA Tech, Inc.	United States of America
Cypress Manufacturing, Ltd.	Cayman Islands
Cypress Semiconductor (Minnesota) Inc.	United States of America
Cypress Semiconductor (Round Rock) Inc.	United States of America
Cypress Semiconductor (Switzerland) Sarl	Switzerland
Cypress Semiconductor (Texas) Inc.	United States of America
Cypress Semiconductor International, Inc.	United States of America
Cypress Semiconductor Ireland Limited	Ireland
Cypress Semiconductor Phil. Headquarters Ltd.	Cayman Islands
Cypress Semiconductor Technology (Shanghai) Co., Ltd.	China
Cypress Semiconductor Technology India Private Limited	India
Cypress Semiconductor Technology Ltd.	Cayman Islands
Deca Technologies Inc.	Cayman Islands
Deca Technologies Inc.	United States of America
Deca Technologies Philippines Headquarters Limited	Cayman Islands
Ramtron International Corporation	United States of America

**CONSENT OF INDEPENDENT REGISTERED PUBLIC ACCOUNTING FIRM**

We hereby consent to the incorporation by reference in the Registration Statements on Form S-3 (Nos. 333-111381, 333-106667 and 333-95711) and in the Registration Statements on Form S-8 (Nos. 333-165750, 333-154748, 333-150484, 333-131494, 333-123192, 333-119049, 333-108175, 333-104672, 333-101479, 333-99221, 333-91812, 333-91764, 333-81398, 333-71530, 333-71528, 333-66076, 333-66074, 333-65512, 333-59428, 333-58896, 333-57542, 333-48716, 333-48714, 333-48712, 333-44264, 333-32898, 333-93839, 333-93719, 333-79997, 333-76667, 333-76665, 333-68703, 333-52035, 333-24831, 333-00535 and 033-59153) of Cypress Semiconductor Corporation of our report dated February 28, 2013 relating to the financial statements, financial statement schedule and the effectiveness of internal control over financial reporting, which appears in Cypress Semiconductor Corporation's Annual Report on Form 10-K for the year ended December 30, 2012.

/s/ PricewaterhouseCoopers LLP

San Jose, California  
February 28, 2013

**CERTIFICATION  
PURSUANT TO SECTION 302 OF SARBANES-OXLEY ACT OF 2002**

I, T.J. Rodgers, certify that:

1. I have reviewed this Annual Report on Form 10-K of Cypress Semiconductor Corporation;
2. Based on my knowledge, this report does not contain any untrue statement of a material fact or omit to state a material fact necessary to make the statements made, in light of the circumstances under which such statements were made, not misleading with respect to the period covered by this report;
3. Based on my knowledge, the financial statements, and other financial information included in this report, fairly present in all material respects the financial condition, results of operations and cash flows of the registrant as of, and for, the periods presented in this report;
4. The registrant's other certifying officer(s) and I are responsible for establishing and maintaining disclosure controls and procedures (as defined in Exchange Act Rules 13a-15(e) and 15d-15(e)) and internal control over financial reporting (as defined in Exchange Act Rules 13a-15(f) and 15d-15(f)) for the registrant and have:
  - a) Designed such disclosure controls and procedures, or caused such disclosure controls and procedures to be designed under our supervision, to ensure that material information relating to the registrant, including its consolidated subsidiaries, is made known to us by others within those entities, particularly during the period in which this report is being prepared;
  - b) Designed such internal control over financial reporting, or caused such internal control over financial reporting to be designed under our supervision, to provide reasonable assurance regarding the reliability of financial reporting and the preparation of financial statements for external purposes in accordance with generally accepted accounting principles;
  - c) Evaluated the effectiveness of the registrant's disclosure controls and procedures and presented in this report our conclusions about the effectiveness of the disclosure controls and procedures, as of the end of the period covered by this report based on such evaluation; and
  - d) Disclosed in this report any change in the registrant's internal control over financial reporting that occurred during the registrant's most recent fiscal quarter (the registrant's fourth fiscal quarter in the case of an annual report) that has materially affected, or is reasonably likely to materially affect, the registrant's internal control over financial reporting; and
5. The registrant's other certifying officer(s) and I have disclosed, based on our most recent evaluation of internal control over financial reporting, to the registrant's auditors and the audit committee of the registrant's board of directors (or persons performing the equivalent functions):
  - a) All significant deficiencies and material weaknesses in the design or operation of internal control over financial reporting which are reasonably likely to adversely affect the registrant's ability to record, process, summarize and report financial information; and
  - b) Any fraud, whether or not material, that involves management or other employees who have a significant role in the registrant's internal control over financial reporting.

Dated: February 28, 2013

By: \_\_\_\_\_ /s/ T.J. RODGERS  
T.J. Rodgers  
President and Chief Executive Officer

**CERTIFICATION  
PURSUANT TO SECTION 302 OF SARBANES-OXLEY ACT OF 2002**

I, Brad W. Buss, certify that:

1. I have reviewed this Annual Report on Form 10-K of Cypress Semiconductor Corporation;
2. Based on my knowledge, this report does not contain any untrue statement of a material fact or omit to state a material fact necessary to make the statements made, in light of the circumstances under which such statements were made, not misleading with respect to the period covered by this report;
3. Based on my knowledge, the financial statements, and other financial information included in this report, fairly present in all material respects the financial condition, results of operations and cash flows of the registrant as of, and for, the periods presented in this report;
4. The registrant's other certifying officer(s) and I are responsible for establishing and maintaining disclosure controls and procedures (as defined in Exchange Act Rules 13a-15(e) and 15d-15(e)) and internal control over financial reporting (as defined in Exchange Act Rules 13a-15(f) and 15d-15(f)) for the registrant and have:
  - a) Designed such disclosure controls and procedures, or caused such disclosure controls and procedures to be designed under our supervision, to ensure that material information relating to the registrant, including its consolidated subsidiaries, is made known to us by others within those entities, particularly during the period in which this report is being prepared;
  - b) Designed such internal control over financial reporting, or caused such internal control over financial reporting to be designed under our supervision, to provide reasonable assurance regarding the reliability of financial reporting and the preparation of financial statements for external purposes in accordance with generally accepted accounting principles;
  - c) Evaluated the effectiveness of the registrant's disclosure controls and procedures and presented in this report our conclusions about the effectiveness of the disclosure controls and procedures, as of the end of the period covered by this report based on such evaluation; and
  - d) Disclosed in this report any change in the registrant's internal control over financial reporting that occurred during the registrant's most recent fiscal quarter (the registrant's fourth fiscal quarter in the case of an annual report) that has materially affected, or is reasonably likely to materially affect, the registrant's internal control over financial reporting; and
5. The registrant's other certifying officer(s) and I have disclosed, based on our most recent evaluation of internal control over financial reporting, to the registrant's auditors and the audit committee of the registrant's board of directors (or persons performing the equivalent functions):
  - a) All significant deficiencies and material weaknesses in the design or operation of internal control over financial reporting which are reasonably likely to adversely affect the registrant's ability to record, process, summarize and report financial information; and
  - b) Any fraud, whether or not material, that involves management or other employees who have a significant role in the registrant's internal control over financial reporting.

Dated: February 28, 2013

By: \_\_\_\_\_ /s/ BRAD W. BUSS

**Brad W. Buss**  
**Executive Vice President, Finance and Administration and**  
**Chief Financial Officer**

**CERTIFICATION PURSUANT TO  
18 U.S.C. SECTION 1350  
AS ADOPTED PURSUANT TO SECTION 906  
OF THE SARBANES-OXLEY ACT OF 2002**

I, T.J. Rodgers, certify, pursuant to 18 U.S.C. Section 1350, as adopted pursuant to Section 906 of the Sarbanes-Oxley Act of 2002, that the Annual Report on Form 10-K of Cypress Semiconductor Corporation for the year ended December 30, 2012 fully complies with the requirements of Section 13(a) or 15(d) of the Securities Exchange Act of 1934 and the information contained in such Annual Report on Form 10-K fairly presents, in all material respects, the financial condition and results of operations of Cypress Semiconductor Corporation.

Dated: February 28, 2013

By: \_\_\_\_\_ /s/ T.J. RODGERS  
**T.J. Rodgers**  
**President and Chief Executive Officer**

**CERTIFICATION PURSUANT TO  
18 U.S.C. SECTION 1350  
AS ADOPTED PURSUANT TO SECTION 906  
OF THE SARBANES-OXLEY ACT OF 2002**

I, Brad W. Buss, certify, pursuant to 18 U.S.C. Section 1350, as adopted pursuant to Section 906 of the Sarbanes-Oxley Act of 2002, that the Annual Report on Form 10-K of Cypress Semiconductor Corporation for the year ended December 30, 2012 fully complies with the requirements of Section 13(a) or 15(d) of the Securities Exchange Act of 1934 and the information contained in such Annual Report on Form 10-K fairly presents, in all material respects, the financial condition and results of operations of Cypress Semiconductor Corporation.

Dated: February 28, 2013

By: \_\_\_\_\_ /s/ BRAD W. BUSS

**Brad W. Buss**  
**Executive Vice President, Finance and**  
**Administration and Chief Financial Officer**





March 29, 2013

Dear Fellow Stockholder:

You are cordially invited to attend Cypress Semiconductor Corporation's 2013 Annual Meeting of Stockholders. We will hold the meeting on Friday, May 10, 2013, at 10:00 a.m. Pacific Daylight Time, at our principal executive offices located at 198 Champion Court, San Jose, California 95134. We look forward to your attendance in person or by proxy at the meeting.

Please refer to the Proxy Statement for detailed information on each of the proposals to be presented at the Annual Meeting. Your vote is important, and we strongly urge you to cast your vote whether or not you plan to attend the Annual Meeting.

If you are a stockholder of record, meaning that you hold shares directly with Computershare Investor Services, LLC, the inspector of elections will have your name on a list, and you will be able to gain entry to the Annual Meeting with any form of government-issued photo identification, such as a driver's license, state-issued ID card, or passport. Stockholders holding stock in brokerage accounts or in "street name" wishing to attend the Annual Meeting in person will also need to bring a letter from their broker reflecting their stock ownership as of the record date, which is March 15, 2013.

Thank you for your ongoing support and continued interest in Cypress Semiconductor Corporation.

Very truly yours,

T.J. Rodgers  
President and Chief Executive Officer

**2013 ANNUAL MEETING OF STOCKHOLDERS  
NOTICE OF ANNUAL MEETING AND PROXY STATEMENT**

**TABLE OF CONTENTS**

	<b>Page</b>
NOTICE OF THE 2013 ANNUAL MEETING OF STOCKHOLDERS .....	1
QUESTIONS AND ANSWERS ABOUT THIS PROXY MATERIAL AND VOTING .....	2
PROPOSAL ONE - ELECTION OF DIRECTORS .....	8
PROPOSAL TWO - RATIFICATION OF THE SELECTION OF INDEPENDENT REGISTERED PUBLIC ACCOUNTING FIRM .....	12
PROPOSAL THREE - ANNUAL ADVISORY VOTE TO APPROVE THE COMPENSATION OF OUR NAMED EXECUTIVE OFFICERS .....	14
PROPOSAL FOUR - APPROVAL OF THE AMENDED AND RESTATED 2013 STOCK PLAN .....	17
PROPOSAL FIVE - APPROVAL OF THE AMENDED AND RESTATED EMPLOYEE STOCK PURCHASE PLAN .....	25
SECURITIES AUTHORIZED FOR ISSUANCE UNDER EQUITY COMPENSATION PLANS .....	30
CORPORATE GOVERNANCE .....	31
BOARD STRUCTURE .....	32
INDEPENDENT DIRECTOR CONTACT .....	34
BOARD LEADERSHIP STRUCTURE .....	34
STOCK OWNERSHIP REQUIREMENTS .....	34
BOARD'S ROLE IN RISK MANAGEMENT OVERSIGHT .....	35
RISK CONSIDERATIONS IN OUR COMPENSATION PROGRAMS .....	35
BOARD COMMITTEES .....	36
COMPENSATION OF DIRECTORS .....	40
REPORT OF THE AUDIT COMMITTEE OF THE BOARD OF DIRECTORS .....	42
SECURITY OWNERSHIP OF CERTAIN BENEFICIAL OWNERS AND MANAGEMENT .....	44
COMPENSATION DISCUSSION AND ANALYSIS ("CD&A") .....	47
REPORT OF THE COMPENSATION COMMITTEE OF THE BOARD OF DIRECTORS .....	64
EXECUTIVE COMPENSATION .....	65
SUMMARY COMPENSATION TABLE .....	65
GRANTS OF PLAN-BASED AWARDS .....	67
OUTSTANDING EQUITY AWARDS .....	68
OPTION EXERCISES AND STOCK VESTING .....	69
NON-QUALIFIED DEFERRED COMPENSATION .....	69
OTHER DISCLOSURES .....	70
COMPENSATION COMMITTEE INTERLOCKS AND INSIDER PARTICIPATION .....	70
POLICIES AND PROCEDURES WITH RESPECT TO RELATED PERSON TRANSACTIONS .....	70
CERTAIN RELATIONSHIPS AND RELATED TRANSACTIONS .....	70
SECTION 16(A) BENEFICIAL OWNERSHIP REPORTING COMPLIANCE .....	70
OTHER MATTERS .....	71
APPENDIX A .....	A-1
APPENDIX B .....	B-1

**CYPRESS SEMICONDUCTOR CORPORATION**  
**NOTICE OF THE 2013 ANNUAL MEETING OF STOCKHOLDERS**

TO ALL CYPRESS STOCKHOLDERS:

NOTICE IS HEREBY GIVEN that the Annual Meeting of Stockholders of Cypress Semiconductor Corporation, a Delaware corporation, will be held on:

Date: Friday, May 10, 2013

Time: 10:00 a.m. Pacific Daylight Time

Place: Cypress's principal executive offices located at 198 Champion Court, San Jose, California 95134

Items of Business:

1. The election of eight (8) directors to serve on our Board of Directors for a one-year term, and until their successors are elected;
2. The ratification of the appointment of PricewaterhouseCoopers LLP as our independent registered public accounting firm for fiscal year 2013;
3. Annual advisory vote to approve the compensation of our Named Executive Officers;
4. Approval of the Amended and Restated 2013 Stock Plan which: (i) renames the plan, (ii) extends the term of the plan, (iii) limits non-employee director equity awards, (iv) seeks stockholder approval for performance-based awards under Section 162(m) of the IRS code, and (v) reduces the number of options/RSUs that may be granted to an individual in a given fiscal year;
5. Approval of the Amended and Restated Employee Stock Purchase Plan which extends the term of the plan and allows for participation by non-U.S. employees; and
6. The transaction of such other business as may properly come before the Annual Meeting, or any adjournment or postponement thereof.

The foregoing items of business are more fully described in the Proxy Statement accompanying this Notice of Annual Meeting of Stockholders. This Notice, the 2012 Annual Report and our 2013 Proxy Statement are being made available to stockholders on or about March 29, 2013.

All stockholders are cordially invited to attend the Annual Meeting in person. Only stockholders of record at the close of business on March 15, 2013 (the "Record Date"), are entitled to receive notice of, and may vote at, the Annual Meeting, or any adjournment or postponement thereof. Any stockholder attending the Annual Meeting and entitled to vote may do so in person even if such stockholder returned a proxy card or voted by telephone or over the Internet. We have provided voting instructions in the attached Proxy Statement on how you can vote your shares at or before the Annual Meeting.

FOR THE BOARD OF DIRECTORS



Brad W. Buss  
*Corporate Secretary*

San Jose, California, March 29, 2013

**CYPRESS SEMICONDUCTOR CORPORATION**  
**PROXY STATEMENT FOR THE 2013 ANNUAL MEETING OF STOCKHOLDERS**  
**QUESTIONS AND ANSWERS ABOUT THE PROXY MATERIALS AND VOTING**

**Q: Why am I receiving these materials?**

A: The Board of Directors (the “Board”) of Cypress Semiconductor Corporation (sometimes referred to as “we”, “us”, “our”, “the Company” or “Cypress”) is providing these proxy materials to solicit your vote at the 2013 Annual Meeting of Stockholders (“Annual Meeting”), or any adjournment or postponement thereof. The Annual Meeting will be held on Friday, May 10, 2013, at 10:00 a.m. Pacific Daylight Time at our principal offices located at 198 Champion Court, San Jose, California 95134. The telephone number at this address is (408) 943-2600.

**Q: Why did I receive a one-page notice in the mail regarding the Internet availability of proxy materials instead of a full set of proxy materials?**

A: In accordance with the rules of the Securities and Exchange Commission (the “SEC”) and in an effort to reduce expenses and provide a convenience to our stockholders, we are furnishing our proxy materials primarily over the Internet on or about March 29, 2013. Therefore, instead of mailing a printed copy of our proxy materials to our stockholders, most of our stockholders will receive a Notice of Availability of Proxy Materials (the “Notice”), which provides instructions on how to access and review our proxy materials on the Internet, or if preferred, request a paper copy of our proxy materials, including this proxy statement (“Proxy Statement”), our 2012 Annual Report and a proxy or voting instruction card. The Notice also provides important instructions on how to submit your vote on the Internet.

**Q: Who may attend the Annual Meeting?**

A: All stockholders and holders of proxies for those stockholders as of March 15, 2013 (the “Record Date”) and other persons invited by Cypress may attend. If you are a stockholder of record, meaning that you hold shares directly with Computershare Investor Services, LLC, the inspector of elections will have your name on a list, and you will be able to gain entry to the Annual Meeting with any form of government-issued photo identification, such as a driver’s license, state-issued ID card, or passport. Stockholders holding stock in brokerage accounts or in “street name” wishing to attend the Annual Meeting in person will also need to bring a letter from their broker reflecting their stock ownership as of the Record Date.

**Q: Who is entitled to vote?**

A: Only stockholders of Cypress as of the close of business on the Record Date are entitled to vote at the Annual Meeting. As of the Record Date, there were 146,723,205 shares outstanding of Cypress’s common stock, par value \$0.01 per share.

**Q: What may I vote on?**

A: You may vote on all the items listed below:

1. The election of eight (8) directors to serve on our Board of Directors for one-year terms, and until their successors are elected;
2. The ratification of the appointment of PricewaterhouseCoopers LLP as our independent registered public accounting firm for the fiscal year 2013;
3. Annual advisory vote to approve the compensation of our Named Executive Officers;

4. Approval of the Amended and Restated 2013 Stock Plan which: (i) renames the plan, (ii) extends the term of the plan, (iii) limits non-employee director equity awards, and (iv) seeks stockholder approval for performance-based awards under Section 162(m) of the IRS code;
5. Approval of the Amended and Restated Employee Stock Purchase Plan which extends the term of the plan and allows for participation by non-U.S. employees; and
6. The transaction of such other business as may properly come before the Annual Meeting, or any adjournment or postponement thereof.

**Q: What is the difference between a registered stockholder or stockholder of record and a beneficial stockholder?**

**A: *Registered Stockholder or Stockholder of Record: Shares Registered in Your Name***

If, on the Record Date, your shares were registered directly in your name with the Company's transfer agent, Computershare Investor Services, LLC, then you are a registered stockholder or a stockholder of record. As a stockholder of record, you may vote in person at the Annual Meeting or you may vote by proxy. Shares held in a bank or brokerage account are not generally registered directly in your name.

***Beneficial Stockholder: Shares Registered in the Name of a Bank or Broker***

If on the Record Date your shares were held in an account at a bank, brokerage firm, dealer, or other similar organization, then you are the beneficial stockholder of shares held in "street name" and these proxy materials are being forwarded to you by that organization. The organization holding your account is considered the stockholder of record for purposes of voting at the Annual Meeting. As a beneficial stockholder, you have the right to direct your bank or broker on how to vote the shares in your account. You are also invited to attend the Annual Meeting. You will be able to gain entry to the Annual Meeting with any form of government-issued photo identification, such as a driver's license, state-issued ID card, or passport, along with a copy of a letter from your bank or broker reflecting your stock ownership as of the Record Date.

However, since you are not the stockholder of record, you may not vote your shares in person at the Annual Meeting unless you request and obtain a valid proxy from your bank or broker in advance of the Annual Meeting.

**Q: How do I vote and what are the voting deadlines?**

**A:** Whether you hold your shares directly as the stockholder of record or beneficially in "street name", you may vote your shares by proxy without attending the Annual Meeting. Depending on how you hold your shares, you may vote your shares in one of the following ways:

***Stockholders of Record:*** If you are a stockholder of record, there are several ways for you to vote your shares.

- **By mail.** If you received printed proxy materials, you may submit your vote by completing, signing and dating each proxy card received and returning it in the prepaid envelope. Sign your name exactly as it appears on the proxy card. Proxy cards submitted by mail must be received no later than May 9, 2013 at 5 p.m. Pacific Daylight Time, to be voted at the Annual Meeting.
- **By telephone or over the Internet.** You may vote your shares by telephone or via the Internet by following the instructions provided in the Notice of Internet Availability of Proxy Materials ("Notice"). If you vote by telephone or via the Internet, you do not need to return a proxy card by mail. Internet and telephone voting are available 24 hours a day. Votes submitted by telephone or through the Internet must be received by 11:59 p.m. Eastern Time on May 9, 2013.
- **In person at the Annual Meeting.** You may vote your shares in person at the Annual Meeting. Even if you plan to attend the Annual Meeting in person, we recommend that you also submit your proxy card or voting instructions, or vote by telephone or via the Internet, by the applicable deadline so that your vote will be counted if you later decide not to attend the Annual Meeting.

**Beneficial Stockholders:** If you are a beneficial owner of your shares, you should have received the Notice and voting instructions from the bank or broker holding your shares. You should follow the instructions in the Notice and voting instructions provided by your bank or broker in order to instruct your bank or broker on how to vote your shares. The availability of telephone and Internet voting will depend on the voting process of the bank or broker. Shares held beneficially may be voted in person at the Annual Meeting only if you obtain a legal proxy from the bank or broker in advance of the Annual Meeting giving you the right to vote your shares.

**Q: What shares may be voted and how may I cast my vote for each proposal?**

A: You may vote all shares you own as of the close of business on the Record Date. You may cast one vote per share of common stock for each proposal, except that a stockholder voting for the election of directors has the right to cumulate such stockholder's votes. This means you may give one candidate a number of votes equal to the number of directors to be elected multiplied by the number of shares you are entitled to vote, or you may distribute your shares among as many director candidates as you may select, provided that your votes cannot be cast for more than eight (8) candidates. For example, if you own 100 shares of stock, and there are eight (8) directors to be elected at the Annual Meeting, you may allocate 800 shares (8 times 100) as "FOR" votes among as few as one (1) or as many as eight (8) directors to be elected at the Annual Meeting. If you choose to cumulate your votes, you will need to submit a proxy card or a ballot and make an explicit statement of your intent to cumulate your votes, either by so indicating in writing on the proxy card or by indicating in writing on your ballot when voting at the Annual Meeting. If you hold shares beneficially in "street name" and wish to cumulate your votes, you should contact your bank or broker.

**Q: What is the effect of a broker non-vote?**

A: Banks and brokers who hold shares of our common stock for a beneficial owner have the discretion to vote on routine proposals even if they have not received voting instructions from the beneficial owner at least ten days prior to the Annual Meeting. A "broker non-vote" occurs when a bank or broker does not receive voting instructions from the beneficial owner and does not have the discretion to direct the voting of the shares on a particular proposal. Broker non-votes will be counted for purposes of calculating whether a quorum is present at the Annual Meeting, but will not be counted for purposes of determining the final vote with respect to a particular proposal. Thus, a broker non-vote will not impact our ability to obtain a quorum and will not otherwise affect the outcome of the vote on a proposal that requires a plurality of votes cast (Proposal 1), an advisory vote (Proposal 3) or the approval by a majority of the votes present in person or represented by proxy and entitled to vote on non-routine proposals (Proposals 4 and 5).

**Q: How many votes are needed to approve each proposal?**

A: With respect to Proposal 1, the eight director nominees receiving the highest number of "FOR" votes will be elected. You may vote "FOR" all nominees, "WITHHOLD" your vote as to all nominees, or "FOR" all nominees except those specific nominees from whom you "WITHHOLD" your vote. A properly executed proxy marked "WITHHOLD" with respect to the election of one or more directors will not be voted with respect to the director or directors indicated. Proxies may not be voted for more than eight directors. If you hold your shares in "street name", your bank or broker is not permitted to vote your uninstructed shares in the election of directors on a discretionary basis. Thus, if you do not instruct your bank or broker how to vote in the election of directors, no votes will be cast on your behalf.

Your bank or broker will, however, continue to have discretion to vote any uninstructed shares on Proposal 2 — the ratification of the appointment of the Company's independent registered public accounting firm. Proposal 3 is only advisory, but your bank or broker does not have the discretion to vote your uninstructed shares. Your bank or broker does not have the discretion to vote your uninstructed shares for Proposals 4 or 5.

With respect to Proposals 2, 3, 4 and 5, we must receive a “FOR” vote from the majority of shares present and entitled to vote either in person or by proxy in order for such proposal to be approved. If you “ABSTAIN” from voting for Proposals 2-5, it will have the same effect as an “AGAINST” vote.

<b>PROPOSAL</b>	<b>VOTE REQUIRED</b>	<b>BROKER DISCRETIONARY VOTE ALLOWED</b>
Proposal 1– Election of eight (8) directors	Plurality of votes cast	No
Proposal 2 – Ratification of PricewaterhouseCoopers LLP as our independent registered public accounting firm	Majority of shares entitled to vote and present in person or represented by proxy	Yes
Proposal 3 – Annual advisory vote to approve compensation of our Named Executive Officers	Majority of shares entitled to vote and present in person or represented by proxy	No
Proposal 4 – Approval of the Amended and Restated 2013 Stock Plan, which extends the term of the Plan, renames the Plan, limits non-employee director equity awards and allows for performance based awards under Section 162(m) of the IRS Code	Majority of shares entitled to vote and present in person or represented by proxy	No
Proposal 5 – Approval of the Amended and Restated Employee Stock Purchase Plan (“ESPP”), which extends the term of the ESPP and allows for participation by non-U.S. employees	Majority of shares entitled to vote and present in person or represented by proxy	No

**Q: What is the advisory vote to approve the compensation of our Named Executive Officers?**

A: At our 2011 Annual Meeting, as recommended by our Board of Directors, a majority of our stockholders voted in favor of including an annual advisory vote on the compensation of our Named Executive Officers identified in our proxy statement (also known as “say-on-pay”) to be held at each annual meeting of stockholders. Therefore, we have included Proposal 3 in this proxy statement to allow our stockholders to provide us a non-binding advisory vote approving the compensation of our Named Executive Officers as disclosed in this Proxy Statement. Your vote on this item will provide our Company with valuable insight into our stockholder’s view on our compensation practices pertaining to our Named Executive Officers.

**Q: What is the quorum requirement?**

A: A quorum of stockholders is necessary to hold a valid annual meeting. A quorum will be present if at least a majority of the outstanding shares are represented by proxy or by stockholders present and entitled to vote at the Annual Meeting. Your shares will be counted towards the quorum only if you submit a valid proxy (or one is submitted on your behalf by your bank or broker) or if you vote in person at the Annual Meeting. Abstentions and broker non-votes will be counted towards the quorum requirement. If there is no quorum, the chairman of the Annual Meeting or holders of a majority of the votes present at the Annual Meeting may adjourn the Annual Meeting to another time or date.

**Q: How can I change my vote or revoke my proxy?**

A: If you are a stockholder of record, you have the right to revoke your proxy and change your vote at any time before the Annual Meeting by (i) returning a later-dated proxy card, or (ii) voting again by Internet or telephone as more fully described on your Notice or proxy card. You may also revoke your proxy and change your vote by voting in person at the Annual Meeting. Attendance at the Annual Meeting will not cause your previously granted proxy to be revoked unless you specifically so request or vote again at the Annual Meeting.

If your shares are held by a bank or broker, you may change your vote by submitting new voting instructions to your bank, broker, trustee or agent, or, if you have obtained a legal proxy from your bank or broker giving you the right to vote your shares, by attending the Annual Meeting and voting in person.

**Q: What does it mean if I get more than one Notice, proxy or voting instructions card?**

A: It means you hold shares in more than one registered account. You must vote all of your proxy cards in one of the manners described above (under “How do I vote and what are the voting deadlines?”) to ensure that all your shares are voted.

**Q: Who will count the votes?**

A: Representatives of Investor Communication Solutions, a division of Broadridge Financial Solutions, Inc., our mailing agent and tabulation service, will count the votes, and Brad W. Buss, our Corporate Secretary, will act as the Inspector of Elections. The procedures to be used by the Inspector of Elections are consistent with Delaware law concerning the voting of shares, determination of a quorum and the vote required to take stockholder action.

**Q: How much did this proxy solicitation cost and who will pay for the cost?**

A: The cost of soliciting your vote in connection with this proxy statement has been, or will be, borne by Cypress. We have also requested that banks, brokers and other custodians, agents and fiduciaries send these proxy materials to the beneficial owners of our common stock they represent and secure their instructions as to the voting of such shares. We may reimburse such banks, brokers and other custodians, agents and fiduciaries representing beneficial owners of our common stock for their expenses in forwarding solicitation materials to such beneficial owners. Certain of our directors, officers or employees may also solicit proxies in person, by telephone, or by electronic communications, but they will not receive any additional compensation for doing so.

**Q: How can I receive the proxy statement and annual report by electronic delivery?**

A: You may sign up for Cypress’s e-delivery program at [www.cypress.com/edeliveryconsent](http://www.cypress.com/edeliveryconsent). When you sign up for our electronic delivery program, you will be notified by e-mail whenever our annual report or proxy statement is available for viewing on the Internet. Your enrollment in the e-delivery program will remain in effect as long as your account remains active or until you cancel your enrollment.

**Q: How can a stockholder request a copy of Cypress’s Annual Report on Form 10-K filed with the SEC for fiscal year 2012?**

A: A stockholder may send a written request for a copy of our Annual Report on Form 10-K to Brad W. Buss, Corporate Secretary, Cypress Semiconductor Corporation, 198 Champion Court, San Jose, California 95134. Upon receipt of such request by a stockholder, we will provide a printed copy of our Annual Report on Form 10-K without charge, including the financial statements and the financial statement schedules, required to be filed with the SEC pursuant to Rule 13a-1 of the Securities Exchange Act of 1934 for our fiscal year 2012. Our Annual Report on Form 10-K for the fiscal year ended December 30, 2012 was filed with the SEC on February 28, 2013, and is also available on our website at: <http://www.cypress.com/go/annualreport>.



**Q: How and when may I submit proposals for consideration at next year's annual meeting of stockholders, or nominate individuals to serve as directors for Cypress?**

A: You may submit your proposals, including director nominations, for consideration at future annual meetings of stockholders by following the directions set forth below:

For stockholder proposals to be considered for inclusion in our 2014 Proxy Statement, the written proposal must be received by our Corporate Secretary at our corporate offices at 198 Champion Court, San Jose, California 95134, no later than November 29, 2013 in accordance with the requirements of Rule 14a-8. In addition, the Company's bylaws establish an advance notice procedure for stockholders who wish to present certain matters or nominate director candidates before or at an annual meeting of stockholders. Stockholders who wish to submit proposals or director nominations but have missed the November 29, 2013 deadline for inclusion in our 2014 proxy statement must deliver written notice to Brad W. Buss, our Corporate Secretary, at our corporate offices at 198 Champion Court, San Jose, California 95134, no earlier than January 13, 2014, and no later than February 12, 2014. Any such proposal must contain the specific information required by the Company's bylaws. In the event the date of next year's annual meeting is moved more than 30 days before or after the anniversary date of this year's Annual Meeting, the deadline for inclusion of stockholder proposals in our proxy statement would instead be a reasonable time before Cypress begins to print and mail its proxy materials, and the deadline for submitting stockholder proposals not to be included in our proxy statement would be no later than the close of business on the later of the 60<sup>th</sup> day prior to such annual meeting or the 10<sup>th</sup> day following the day on which public announcement of the date of such meeting is first made. All stockholder proposals will also need to comply with SEC regulations, including Rule 14a-8 of the 1934 Securities Exchange Act regarding the inclusion of stockholder proposals in any Company-sponsored proxy materials.

A submission by a stockholder must contain the specific information required in the Company's bylaws. If you would like a copy of Cypress's current bylaws, please write to Brad W. Buss, Corporate Secretary, 198 Champion Court, San Jose, California 95134.

**Q: Where can I find the voting results of the Annual Meeting?**

A: Cypress will announce preliminary voting results at the 2013 Annual Meeting and file a Current Report on Form 8-K announcing the final voting results after the Annual Meeting.

**Q: How many copies of the proxy materials will you deliver to stockholders sharing the same address?**

A: To reduce the expenses of delivering duplicate proxy materials, we are taking advantage of the SEC's "householding" rules that permit us to deliver only one set of proxy materials to stockholders who share an address, unless otherwise requested by the stockholders. If you have not enrolled in our electronic delivery program, share an address with another stockholder and have received only one set of proxy materials and desire or require to receive additional copies of the proxy materials, you may request a separate copy of these materials, including the Annual Report, at no cost to you by writing to Brad W. Buss, Corporate Secretary, Cypress Semiconductor Corporation, 198 Champion Court, San Jose, California 95134. The telephone number is (408) 934-2600. For future annual meetings, you may request separate voting materials, or request that we send only one set of proxy materials to you if you are receiving multiple copies, by writing to Investor Relations at the address given above.

**IMPORTANT INFORMATION REGARDING THE AVAILABILITY OF PROXY MATERIALS FOR THE 2013 ANNUAL MEETING OF STOCKHOLDERS TO BE HELD MAY 10, 2013.**

Copies of this Proxy Statement and our 2012 Annual Report to stockholders are also available online at <http://www.cypress.com/go/annualreport>. You are encouraged to access and review all of the important information contained in the proxy materials before voting.

**PROPOSAL ONE**  
**ELECTION OF DIRECTORS**

A board of eight (8) directors is to be elected at the 2013 Annual Meeting. Proxies can only be voted for the number of nominees named in this Proxy Statement. All directors are elected annually and serve a one-year term until the next annual meeting where they or their successors are elected. If you submit a signed proxy card that does not specify how you wish to vote, your shares will be voted for the eight (8) director nominees named below, each of whom is presently serving as our director. If any nominee is unable or declines to serve as a director at the time of the Annual Meeting, the proxies will be voted for any nominee designated by the present Board to fill the vacancy. We do not expect any nominee will be unable or will decline to serve as a director. There are no arrangements or understandings between any nominee and any other person pursuant to which he was selected as a director or a nominee. As of the time of filing of this Proxy Statement, there were no director candidates recommended by stockholders or stockholder groups beneficially owning 5% of voting common stock for at least one year.

**Nominees for Election to Our Board of Directors**  
(as of March 15, 2013)

<b>Name of Nominee</b>	<b>Age</b>	<b>Principal Occupation</b>	<b>Director Since</b>
T.J. Rodgers	65	President and Chief Executive Officer of Cypress	1982
W. Steve Albrecht	66	Andersen Alumni Professor of Accounting, Marriott School of Management, Brigham Young University	2003
Eric A. Benhamou	57	Chairman of our Board, and former Chief Executive Officer of Palm, Inc. and 3Com Corporation	1993
Lloyd Carney	51	Chief Executive Officer of Brocade Communications Systems	2005
James R. Long	70	Consultant, Former Executive Vice President of Nortel Networks Corporation	2000
J. Daniel McCranie	69	Chairman of the Board of ON Semiconductor	2005
J. D. Sherman	47	President and Chief Operating Officer, HubSpot	2010
Wilbert van den Hoek	56	Consultant, Former Executive Vice President and Chief Technology Officer of Novellus Systems, Inc.	2011

Except as set forth below, each of the nominees has been engaged in his principal occupation described above during the past five (5) years. There are no family relationships among our directors and executive officers.

*T.J. Rodgers* is the founder, president, chief executive officer, and a director of Cypress Semiconductor Corporation. He sits on the board of directors of Cypress's internal subsidiaries, AgigA Tech, Inc. and Deca Technologies Inc., as well as Bloom Energy, a privately-held fuel cell company, and until recently, he was on the board of directors of SunPower Corporation, a public company. He was also a Trustee of Dartmouth College, his alma mater. Mr. Rodgers was a Sloan scholar at Dartmouth, where he graduated with a double major in physics and chemistry. He attended Stanford University on a Hertz fellowship, earning a master's degree and a Ph.D. in electrical engineering. He managed the MOS memory design group at AMI from 1975 to 1980 before moving to Advanced Micro Devices ("AMD"), where he ran AMD's static RAM product group until 1982, when he founded Cypress. As Cypress's founder, Mr. Rodgers has the benefit of the Company's complete history. This advantage, taken together with his expert technical and analytical skills, long-term executive experience, and over four decades of experience in the semiconductor industry, make him uniquely qualified to be on our Board.

*W. Steve Albrecht* is an Andersen Alumni Professor of Accounting at the Marriott School of Management at Brigham Young University (“BYU”). He served as the associate dean of the school until July 2008. Mr. Albrecht, a certified public accountant, certified internal auditor, and certified fraud examiner, joined BYU in 1977 after teaching at Stanford University and the University of Illinois. Prior to becoming a professor, he worked as an accountant for Deloitte & Touche. Mr. Albrecht is the past president of the American Accounting Association and the Association of Certified Fraud Examiners. He served on the board of directors of SunPower Corporation from 2005 to 2012. Until his resignation in 2009 due to an international assignment, Mr. Albrecht served on the board of directors of Red Hat from 2003, and SkyWest, Inc. from 2003. In 2011, he was re-appointed to the board of directors of Red Hat and in 2012 was reappointed to the board of directors of SkyWest, Inc. He is a former trustee of the Financial Accounting Foundation that provides oversight to the Financial Accounting Standards Board (“FASB”) and the Governmental Accounting Standards Board. He is also a former member of COSO, the organization that developed the internal control framework used by most companies. He has consulted with numerous corporations on fraud, controls and financial reporting issues. He has been an expert witness in several large financial statement fraud cases. Mr. Albrecht holds a Bachelor of Science degree from Brigham Young University, a Masters degree in Business Administration and a Doctorate degree in Accounting from the University of Wisconsin. Mr. Albrecht’s extensive experience with public and financial accounting matters, especially with respect to multi-national companies, makes him well-qualified to be on our Board.

*Eric A. Benhamou* is the chairman of our Board of Directors and former chairman of the board of 3Com Corporation. He served as chief executive officer of Palm, Inc. from October 2001 until October 2003 and chairman until October 2007, and was chief executive officer of 3Com from 1990 until the end of 2000. Mr. Benhamou co-founded Bridge Communications, an early networking pioneer, and was vice president of engineering until its merger with 3Com in 1987. He is also a member of the board of directors of Silicon Valley Bank. He serves on the Stanford University School of Engineering board and is vice chairman of the board of governors of Ben Gurion University of the Negev. He is the chief executive officer of Benhamou Global Ventures, an investment firm he established in 2004. Mr. Benhamou holds a Master of Science degree from Stanford University’s School of Engineering and a Diplôme d’Ingénieur and a doctorate from Ecole Nationale Supérieure d’Arts et Métiers, Paris. In addition to his engineering expertise, we believe Mr. Benhamou’s extensive experience managing public companies in the technology sector, as well as his expertise in venture and other financial transactions, makes him well-qualified to be on our Board.

*Lloyd Carney* is the chief executive officer of Brocade Communications Systems, a NASDAQ listed company. He was previously the chief executive officer and a director of Xsigo Systems, a venture funded IO Virtualization Platform, which was successfully sold to Oracle Corporation. He is a member of the board of directors of Technicolor and serves as the chairman of that board’s Technology Committee. Prior to joining Xsigo in 2008, he was the general manager of IBM’s NetCool Division from 2006 to 2007. Prior to his employment at IBM, he was the chairman and chief executive officer of Micromuse from 2003-2005 before it was acquired by IBM in 2006. Prior to Micromuse, Mr. Carney was the chief operations officer and executive vice president at Juniper Networks where he oversaw the engineering, product management and manufacturing divisions from 2002 until July 2003. Prior to joining Juniper Networks, Mr. Carney was the president of the Core IP Division, the Wireless Internet Division and the Enterprise Data Division at Nortel Networks from 1997 until 2001. Mr. Carney brings to our Board broad-based experience in the semiconductor and non-semiconductor industries. Mr. Carney holds a Bachelor of Science degree in Electrical Engineering Technology from Wentworth Institute and a Master of Science degree in Applied Business Management from Lesley College, Cambridge, Massachusetts. We believe Mr. Carney is well-qualified to be on our Board because he possesses significant executive, entrepreneurial and operational expertise.

*James R. Long* has been an independent business consultant since 1999 when he retired as executive vice president of Nortel Networks Corporation and president of Nortel Enterprise Solutions. Between 1991 and 1999, Mr. Long was the president of various business units at Nortel Networks, including Asia Pacific, Nortel World Trade, and the Enterprise Solutions group. Prior to joining Nortel, Mr. Long held a variety of senior executive

positions with IBM Corporation and Rolm Company, an IBM and Siemens joint venture. He previously served on the board of directors of 3Com Corporation, NCR Corporation, and still serves on the board of directors of the Polynesian Cultural Center. He is also a member of the National Advisory Council of the Marriott School of Management at Brigham Young University. Mr. Long holds a Bachelor of Science degree from San Jose State University. In addition to his corporate strategy skills, we believe Mr. Long's extensive executive experience, especially with public companies, makes him well-qualified to be on our Board.

*J. Daniel McCranie* serves as the chairman of the board of directors of ON Semiconductor, a position he has held since 2002. Mr. McCranie is also chairman of the board of directors of Freescale Semiconductor, a position he held through most of fiscal year 2012, as well as a member of the board of directors of Mentor Graphics. Previously, he served as chairman of the board of directors of Virage Logic and chairman of the board of directors of Actel Corporation. In the recent past, Mr. McCranie served as chairman of the board of Xicor Corporation, a member of the board of directors for California Microdevices, and a member of the board of directors for ASAT Corporation. Mr. McCranie served as Cypress's executive vice president of sales and marketing from 1993-2001. Prior to his initial tenure with Cypress, Mr. McCranie was the chairman of the board, president and chief executive officer of SEEQ Technology. Mr. McCranie holds a Bachelor of Science degree in electrical engineering from Virginia Polytechnic Institute and State University (Virginia Tech). We believe Mr. McCranie is well-qualified to be on our Board due to his extensive sales and marketing experience, in-depth knowledge of the semiconductor industry and his leadership skills as evidenced by his executive positions and various board memberships.

*J. D. Sherman* is the president and chief operating officer of HubSpot, a marketing software company. Prior to joining HubSpot, Mr. Sherman was the chief financial officer at Akamai Technologies, a leading web networking infrastructure company, from November 2005 to February 2012. Prior to Akamai, he served as the chief financial executive of IBM's Systems and Technology Group from January until October 2005. During his 15-year career at IBM, he held a number of senior executive positions in finance, including vice president of finance and planning for the company's zSeries Server Division. Mr. Sherman also served as chief financial officer for CommQuest, a wholly owned IBM subsidiary in the wireless semiconductor design industry from 1998 until 2000. Mr. Sherman previously served on the board of directors of 3Com and AMI Semiconductor. Mr. Sherman holds a master's degree in business administration from the University of Chicago and a bachelor's degree in Economics from Emory University. We believe Mr. Sherman is well-qualified to sit on our Board because of his extensive executive management, strong financial and business acumen and leadership in a large public technology company.

*Wilbert van den Hoek* retired from Novellus Systems, Inc. in 2008, where he was executive vice president and chief technology officer. He also served as president and chief executive officer of Novellus Development Company, LLC, a wholly-owned subsidiary of Novellus Systems, Inc. from 2005 until 2008. He joined Novellus Systems, Inc. in 1990 and served in various senior executive positions until his retirement in 2008. From 1980 to 1990, he held various positions at Philips Research Laboratories. From 2004 until 2006 when the company went public, he served on the board of directors of Neah Power Systems, Inc. Since 2005, he has served on the technical advisory boards of various organizations, including Cavendish Kinetics, Inc., Innopad, Inc., Innovent Technologies, LLC and Process Relations. He currently serves on the board of directors of Integrated PhotoVoltaic, Inc., a privately-held company and previously served on the board of SDC Materials and Replisaurus Technologies, Inc. Mr. van den Hoek received a Doctorandus degree in Chemistry from the Rijks Universiteit Utrecht, The Netherlands in December 1979. We believe that Mr. van den Hoek is well-qualified to sit on our Board because of his extensive experience as a senior executive in the semiconductor manufacturing equipment industry and as a consultant to many semiconductor and other high technology companies, his understanding of semiconductor industry business models, segments, and competition, and his experience as a director at other technology companies.

In addition to the biographical information above regarding each nominee's specific experience, attributes, positions and qualifications, we believe that each of our director nominees has performed his duties

with critical attributes such as honesty, integrity and an adherence to high ethical standards. Each of them has demonstrated strong business acumen and an ability to exercise sound judgment, as well as a commitment to the Company and its core values. Finally, we value their significant leadership and experience on other public company boards and board committees.

### **Required Vote**

The eight (8) nominees receiving the highest number of affirmative votes of the shares present or represented and entitled to vote shall be elected as directors to serve until our next annual meeting, where they or their successors will be elected. Votes withheld from this proposal are counted for purposes of determining the presence or absence of a quorum for the transaction of business, but have no further legal effect under Delaware law.

- THE BOARD OF DIRECTORS UNANIMOUSLY RECOMMENDS A VOTE “FOR” THE ELECTION TO THE BOARD OF EACH OF THE NOMINEES PROPOSED ABOVE.**

**PROPOSAL TWO**  
**RATIFICATION OF THE SELECTION OF INDEPENDENT REGISTERED**  
**PUBLIC ACCOUNTING FIRM**

The Board of Directors, upon recommendation of the Audit Committee, has reappointed the firm of PricewaterhouseCoopers LLP as our independent registered public accounting firm for the fiscal year ending December 29, 2013, subject to ratification by our stockholders.

PricewaterhouseCoopers LLP has served as our independent registered public accounting firm since 1982. A representative of PricewaterhouseCoopers LLP is expected to be present at the 2013 Annual Meeting and will have an opportunity to make a statement if he or she desires to do so, and will be available to respond to appropriate questions.

Stockholder ratification of the selection of PricewaterhouseCoopers LLP as our independent registered public accounting firm is not required by our bylaws or other applicable legal requirements. However, the Board is submitting the selection of PricewaterhouseCoopers LLP to the stockholders for ratification as a matter of good corporate practice.

If the stockholders fail to ratify the selection of our independent registered public accounting firm, the Audit Committee and the Board will reconsider whether or not to retain that firm. Even if the selection is ratified, the Board, at its discretion, may direct the appointment of a different independent registered public accounting firm at any time during the year if it determines that such a change would be in the best interest of Cypress and its stockholders.

*All fees billed to Cypress by PricewaterhouseCoopers LLP for fiscal years 2012 and 2011 were pre-approved by the Audit Committee and were as follows:*

Services	2012	2011
Audit Fees	\$2,120,800	\$1,750,900
Audit-Related Fees	\$38,300	\$43,000
Tax Fees	\$651,600	\$1,177,100
All Other Fees	—	—
<b>Total</b>	<b>\$2,810,700</b>	<b>\$2,971,000</b>

**Audit Fees:** Includes fees associated with the annual audit of our financial statements and internal control over financial reporting in compliance with regulatory requirements under the Sarbanes-Oxley Act, review of our quarterly reports on Form 10-Q, annual report on Form 10-K and periodic reports on Form 8-K, consents issued in connection with our Form S-8 filings, assistance and review with other documents we filed with the SEC, and statutory audits required internationally.

**Audit-Related Fees:** Audit-related services principally include employee benefit plan audits, internal control consulting, and accounting consultations not associated with the regular audit.

**Tax Fees:** Includes fees for tax compliance (tax return preparation assistance and expatriate tax services), general tax planning, tax-related services on acquisitions and international tax consulting.

**Audit Committee Pre-Approval Policy**

The Audit Committee has adopted a policy that requires advance approval of all audit services, audit-related services, tax, and other services performed by the Company's independent registered public accounting firm. With the exception of certain de-minimis amounts, unless the specific service has been previously pre-approved with respect to that fiscal year, the Audit Committee must approve the permitted service before the independent registered public accounting firm is engaged to perform such services for Cypress.

**Required Vote**

The affirmative vote of the holders of a majority of the shares represented and entitled to vote at the meeting will be required to ratify the selection of PricewaterhouseCoopers LLP as our independent registered public accounting firm for the fiscal year ending December 29, 2013.

- THE BOARD OF DIRECTORS UNANIMOUSLY RECOMMENDS A VOTE "FOR" THE RATIFICATION OF THE APPOINTMENT OF PRICEWATERHOUSECOOPERS LLP AS OUR INDEPENDENT REGISTERED PUBLIC ACCOUNTING FIRM.**

## PROPOSAL THREE

### ADVISORY VOTE TO APPROVE THE COMPENSATION OF OUR NAMED EXECUTIVE OFFICERS

The Dodd-Frank Act enables our stockholders to vote to approve, on an advisory (non-binding) basis, the compensation of our Named Executive Officers (“NEO”) as disclosed in this Proxy Statement in accordance with the SEC rules. We are providing this proposal for the vote of our stockholders pursuant to section 14A of the Securities Exchange Act of 1934, as amended.

Our executive compensation programs are designed to attract, motivate, and retain our Named Executive Officers, who are critical to our success. Our executive compensation programs have played a material role in our ability to drive strong financial results and attract and retain an experienced, successful team to manage our Company. Under these programs, our Named Executive Officers are rewarded for achieving specific annual, long- and short-term and strategic, corporate goals, and realizing increased stockholder value. Please read the “*Compensation Discussion and Analysis*” for additional details about our executive compensation programs, including information about the fiscal year 2012 compensation of our Named Executive Officers.

The Compensation Committee continually reviews the compensation programs for our Named Executive Officers to ensure they achieve the desired goal of aligning our executive compensation structure with our stockholders’ interests and current market practices. We have asked for stockholder advisory votes on the compensation of our named executive officers annually since 2011 and we have received stockholder approval ratings of over 76% each time. We appreciate the vote of confidence that our stockholders have shown in our compensation philosophy and our 2012 results reflect the pay for performance philosophy we have in place. For the fiscal year ended December 30, 2012:

- our revenue decreased 22.7% in fiscal year 2012 due to certain end customer issues and a weak macro environment.
- GAAP earnings per share decreased from \$0.90 in fiscal year 2011 to a loss of \$0.15 per share in fiscal year 2012 due to lower earnings, one-time items that were benefits in 2011 that did not occur in 2012 and one-time acquisition related expenses associated with the Ramtron acquisition.
- non-GAAP earnings per share decreased from \$1.25 in fiscal year 2011 to \$0.55 in fiscal year 2012 due mainly to lower earnings.
- cash flow from operations totaled \$135 million or 17.5% of revenue.
- we achieved a fiscal year 2012 non-GAAP return on assets of 52%.
- we returned \$295 million in cash to our stockholders through our stock repurchase and dividend programs.
- we increased our quarterly dividend from \$0.09 per share to \$0.11 per share, a current yield of approximately 4% which is a rate almost 200% greater than the S&P.
- we achieved significant major new product launches in SRAM, USB, PSoC and TrueTouch.
- we further enhanced our product portfolio by acquiring Ramtron International Corporation and divesting Cypress Envirosystems, Inc.
- our three-year average equity net burn rate (which reflects the potential dilutive effect of our annual stock grants is calculated by expressing the total net equity awards in a given year as a percentage of the total number of common shares outstanding) of 1.9% continues to be well below industry standards.
- stock-based compensation expense decreased 26% in 2012 to the lowest level since 2006.



For fiscal year 2012 our compensation plans, which are mostly variable and pay for performance in nature, yielded the following results:

- No NEOs received a base salary increase for the second year in a row and our CEO has not had a base salary increase since 2006.
- Earned amounts under our cash incentive bonus plans decreased 94% from fiscal year 2011.
- Earned PARS shares decreased 66% from fiscal year 2011.
- Earned PARS share dollar value decreased 80% from fiscal year 2011; the lowest amount earned since the PARs program was introduced in 2007.
- Total earned and delivered compensation dollar value for all NEOs decreased approximately 81% from fiscal year 2011 due to lower shares earned and a significantly lower stock price.

Our executive compensation program strikes the appropriate balance between utilizing responsible, measured pay practices and effectively incentivizing our executives to achieve long-term value creation for our stockholders. This balance is evidenced by the following:

- Our compensation programs are substantially tied to our key business objectives and the success of our stockholders.
- If the value we deliver to our stockholders declines, so does the compensation of our Named Executive Officers.
- We closely monitor the compensation programs and pay levels of executives from companies of similar size and complexity, so that we may ensure that our compensation programs are within the range of our peer group companies and market practices.
- We provide a significant part of executive compensation on performance-based incentives, including primarily performance-based restricted stock units and variable cash bonuses.
- None of our NEOs have been granted any service-based stock awards while serving as a NEO for over five years.
- Payouts of performance-based restricted stock units are based on the achievement of a minimum financial performance metric and are capped at 100% of the total maximum targeted share awards. If the minimum financial metric is not achieved, the shares are forfeited and are not earnable in the future.
- We have no employment, severance or golden parachute agreements with any of our Named Executive Officers and therefore, no excise tax gross-ups.

We are asking our stockholders to indicate their support for our Named Executive Officer compensation as described in this Proxy Statement. This proposal, commonly known as a “say-on-pay” proposal, gives our stockholders the opportunity to express their views on our Named Executive Officers’ compensation. This vote is not intended to address any specific item of compensation, but rather the overall compensation of our Named Executive Officers and the philosophy, policies and practices described in this Proxy Statement. Accordingly, we ask our stockholders to vote “FOR” the following resolution at the Annual Meeting:

“RESOLVED, that the Company’s stockholders approve, on an advisory basis, the compensation of the Named Executive Officers, as disclosed in the Company’s Proxy Statement for the 2013 Annual Meeting of Stockholders pursuant to the compensation disclosure rules of the Securities and Exchange Commission, including the Compensation Discussion and Analysis, the 2012 Summary Compensation Table and the other related tables and disclosure pursuant to Item 402 of Regulation S-K of the Securities and Exchange Commission.”

The say-on-pay vote is advisory, and therefore not binding on the Company, our Compensation Committee or our Board. Our Board and our Compensation Committee value the opinions of our stockholders

and to the extent there is any significant vote against the Named Executive Officer compensation as disclosed in this Proxy Statement, we will consider our stockholders' concerns and our Compensation Committee will evaluate whether any actions are necessary to address those concerns.

- THE BOARD OF DIRECTORS UNANIMOUSLY RECOMMENDS A VOTE “FOR” THE APPROVAL OF THE COMPENSATION OF OUR NAMED EXECUTIVE OFFICERS, AS DISCLOSED IN THIS PROXY STATEMENT PURSUANT TO THE COMPENSATION DISCLOSURE RULES OF THE SECURITIES AND EXCHANGE COMMISSION.**

## PROPOSAL FOUR

### APPROVAL OF THE AMENDED AND RESTATED 2013 STOCK PLAN

#### Background

Our 1994 Stock Plan (the “Plan”), allows us to grant equity compensation awards to our employees, officers and directors. The Plan permits us to grant service-based awards and performance-based awards, including our performance accelerated restricted stock (“PARS”) program that we adopted in 2007 to retain and incentivize key employees. Under the PARS program, we awarded performance-based restricted stock units (“RSUs”) to key employees, including our Named Executive Officers (“NEOs”) and our other executive officers, which could be earned from 2007 through 2011. With the exception of one service-based award to one of our executive officers, our executive officers, including our NEOs, have not received any equity awards other than their PARS grant since 2007. In 2012, our executive officers received a one-year performance-based grant more fully described under *Fiscal Year 2012 Compensation Actions* of this Proxy Statement. As of March 1, 2013, the Plan had approximately 3,500 eligible participants and approximately 19.2 million shares remaining available for grant.

#### **WE ARE NOT ASKING YOU TO APPROVE THE ADDITION OF ANY NEW SHARES TO THE PLAN.**

Our Board of Directors approved the amendment and restatement of the Plan (as amended and restated, the “Amended Plan”) on March 18, 2013, subject to approval by our stockholders at the 2013 Annual Meeting. We are asking our stockholders to:

- extend the term of the Plan to January 15, 2024;
- add a limitation on the total value of equity awards any non-employee director may receive in a given fiscal year;
- approve the reduction of the number of options and RSUs that may be granted to a single participant in a given year;
- approve the grant of performance-based awards, in order to preserve the ability to deduct certain qualified performance-based compensation under Internal Revenue Code Section 162(m); and
- change the name of the Plan from the 1994 Stock Plan to the 2013 Stock Plan.

If our stockholders do not approve this proposal, it will be a material event and may cause significant employee turnover, impact our ability to hire future employees and add significant additional cash compensation costs that could total approximately \$70 million to \$100 million dollars and not provide the desired long-term alignment with our stockholders that the equity plan currently provides. In addition, our executive team, including our CEO, would not have any unvested stock awards and thus we would have no long-term retention tool and be at a substantial competitive disadvantage and be subject to significant turnover. Furthermore, we would not, on or after the 2013 Annual Meeting, be able to make any Performance-Based Full Value Awards to individuals who are or are likely to become “covered employees” within the meaning of Internal Revenue Code Section 162(m).

#### Summary of the Proposal

The Amended Plan extends the life of the Plan by the standard ten years used by most of our competitors, adds a limitation to non-employee director grants of no more than \$500,000, increased to \$750,000 in connection with a non-employee director’s initial service, approves the material terms of the plan (including the objective performance metrics applicable to performance-based vesting full-value awards and changes the name of the Plan. **We are not asking our stockholders to approve adding any additional shares to the grant pool.**

This proposal summarizes why our stockholders should approve this proposal. It also describes the major features of the Amended Plan, but this description is qualified in its entirety by reference to the actual text of the Amended Plan, set forth as Appendix A to this Proxy Statement.

### **The Plan is a Critical Element of our Compensation Policy**

Our employees are our most valuable asset. Accordingly, the approval of the Amended Plan is in the best interests of our stockholders, as equity awards granted under the plan help us to:

- attract, motivate, and retain talented employees, consultants and non-employee directors;
- align employee and stockholder interests;
- link employee compensation with company performance; and
- maintain a culture based on employee stock ownership.

If this proposal is approved, the Compensation Committee (the “Committee”) intends to continue to grant only performance-based equity awards to our executive officers in fiscal year 2013.

If our stockholders do not approve the Amended Plan, our plans for growth could be significantly hampered and our ability to operate our business, especially in our core and growing Programmable Systems Division, could be adversely affected. Furthermore, we may be compelled to instead offer material cash-based incentives to compete for talent, which could have a significant effect upon our quarterly results of operations and balance sheet. Moreover, this would not be competitive with most other technology companies.

Our success over the past few years is largely due to our highly talented employee base. Our future success depends heavily on our ability to attract and retain high caliber employees, consultants and board members. The ability to grant equity awards is a necessary and powerful recruiting and retention tool for us to hire and motivate the quality personnel we need to move our business forward on a long-term basis.

Broadening markets for our products and services, our broadening customer base, our geographic diversity and increasing product complexity all drive requirements for a different skill set of employees and consultants that are in high demand, including: design engineers, software engineers, analog engineers, system engineers, and technical sales personnel. We face intense competition in attracting these professionals from traditional semiconductor to start-up companies as well as internet and social networking companies. The competition for talent is particularly intense in Silicon Valley. Cypress had more than 750 new hires in 2012 to replace employee turnover and invest in future growth areas. We expect to have approximately 500 new hires in 2013 and 600 in 2014. Over 50% of our new hires are in technical positions, where we compete with a wide range of companies who offer equity awards as an integral part of their hiring programs. This influx of new talent is essential to expand the skill set required to accelerate the design, manufacture and marketing of our higher value added products, software and solutions. Additionally, we have approximately 2,300 non-manufacturing employees relative to our peers. All of our employees receive a new hire grant and a significant percentage participates in an annual process in which they may be awarded equity service-based grants based on each employee’s performance.

### **The Plan Conforms to Best Practices**

We designed the Plan to conform to best practices in equity incentive plans. For example, the Plan:

- prohibits equity award repricing without stockholder approval;
- does not permit options or stock appreciation rights to be granted with a term exceeding eight years;
- permits the granting of full-value awards such as restricted stock and restricted stock units, which can be used in lieu of stock options to reduce the total number of our shares necessary to grant competitive equity awards;

- applies a fungible share design whereby each full-value award issued results in a reduction to the Plan share pool of 1.88 shares;
- provides annual limits on the number of shares that can be granted to participants; and
- provides annual limits on the value of equity awards that can be granted to non-employee members of our Board of Directors.

Outstanding Employee Equity Awards, as of March 1, 2013

	Former Ramtron Stock Plan	Cypress 1994 Stock Plan	Total
<b>Shares Available for Grant</b>	1.1 million	19.2 million	20.3 million
<b>Fungible Share Award Equivalent</b>	1.53	1.88	
<b>Outstanding Employee Equity Awards:</b>			
<b>Full Value Awards</b>	.4 million	4.2 million	4.6 million
<b>Options</b>	.4 million	21.6 million	21.9 million
<b>Weighted average exercise price</b>	—	—	\$7.26 / option
<b>Record Date Outstanding Shares</b>	—	—	146.7 million

### Shareholder Value Transfer (SVT)

Institutional Shareholder Services (“ISS”) is an influential advisor to many investors, including many of our stockholders. Among other things, ISS evaluates the cost of proposals, such as this one, to extend the term of the Plan by ten years without any increase in the equity plan share reserve. Based upon its analyses, ISS then advises stockholders to vote either for or against such proposals. One of the most significant tests in ISS’s analysis of equity plan proposals is shareholder value transfer (“SVT”), which measures stockholder dilution both in terms of a dollar amount and as a percentage of a company’s market value.

If a company’s SVT is too great, ISS will view the equity plan proposal as too costly and will recommend voting against the equity plan proposal despite the fact that we are NOT asking stockholders to approve additional shares for our employee equity plan.

### Our Shareholder Value Transfer (SVT) Rate is High Largely Due to Our Aggressive Stock Repurchase Program

Many companies, including Cypress, have implemented aggressive stock repurchase programs to return excess cash to stockholders in a tax efficient manner. Cypress’s ability to grant equity awards should not be jeopardized because Cypress has repurchased shares in an effort to increase returns to our stockholders.

Over the years we have maintained aggressive stock repurchase programs which have materially and negatively affected our SVT calculation. Our stock price appreciation over the past four years has been significant as compared to our peers.

The table below details the non-equity returns we have provided to our stockholders over the past five years:

<b>Year</b>	<b>Shares Bought (Millions)</b>	<b>Cost (Millions)</b>	<b>Dividend (Millions)</b>
2012	18.0	\$231.8	\$63.2
2011	36.0	\$650.7	\$29.0
2010	12.6	\$154.9	—
2009	7.7	\$61.8	—
2008 — Post SunPower Spin-Off	25.1	\$104.7	
September 29, 2008 — Distribution of SPWRB Common Shares	—	—	\$2,554.0
2008 — Pre SunPower Spin-Off	12.6	\$277.1	—
<b>Total</b>	<b>112.0</b>	<b>\$1,481.0</b>	<b>\$2,646.2</b>

Stockholders may analyze the SVT calculation in three different ways, all of which simulate ISS methodologies for calculating SVT. Each outstanding award is valued calculating a binomial value using the weighted average exercise price of all options and the 200 day moving average of Cypress's stock price. These values are then expressed as a percentage of Cypress's market capitalization. All shares available for grant are assumed to be issued as full value awards.

SVT#1 is the baseline example as of March 1, 2013, and is calculated using our current outstanding equity awards (as detailed above) with no adjustments for historical stock repurchases. Our SVT calculated in this manner is approximately 19% and above the range of what we estimate is the industry standard, which is 13% — 15%.

SVT#2 adjusts the baseline as represented in SVT#1 by adjusting the shares outstanding for the 112 million shares repurchased from January 1, 2008 through March 1, 2013. The resulting SVT is approximately 11% and is well under our estimated industry mid-point target of 14%.

SVT#3 assumes all of the unexercised in-the-money options held by our NEOs, which total 5.8 million shares, were exercised on March 1, 2013. Our SVT would have declined to 16% if the assumption had been met. Our SVT calculated in this manner is just beyond the high end of the range of what we estimate is the industry standard, 13% to 15%.

	<b>SVT#1</b>	<b>SVT#2(1)</b>	<b>SVT#3(2)</b>
<b>CY CALCULATED SVT:</b>	19%	11%	16%
<b>Industry Mid-Point</b>	14%	14%	14%
<b>SVT INPUT:</b>			
<b>New Shares</b>	0	0	0
<b>Available For Grant</b>	20.3M	20.3M	20.3M
<b>Options Outstanding</b>	21.9M	21.9M	16.1M
<b>RSU/RSA Outstanding</b>	4.6M	4.6M	4.6M
<b>Shares Outstanding</b>	146.7M	258.7M	152.5M

- (1) Adjusted to show the impact of the 112 million shares repurchased by the Company since 2008.
- (2) Assumes all of the 5.8 million outstanding in-the-money options held by our NEOs will be exercised.

Outstanding Equity Awards  
Fiscal Year Ended  
December 30, 2012

Name and Principal Position	Number of Securities Underlying Unexercised Options (#) Exercisable	Number of Securities Underlying Unexercised Options (#) Unexercisable	Option Exercise Price (\$)	Option Expiration Date
T.J. Rodgers President and Chief Executive Officer	1,442,077	—	5.18	1/2/2014
	1,442,077	—	3.53	2/25/2015
	3,028	—	8.83	2/25/2015
	5,306	—	3.53	2/25/2015
	1,251,093	—	3.53	6/30/2016
<b>Total</b>	<b>4,143,581</b>	—	—	—
Brad W. Buss Executive Vice President, Finance and Administration, Chief Financial Officer	90,699	—	3.70	8/15/2015
	209,016	—	3.70	8/15/2015
	131,847	—	3.99	10/27/2016
<b>Total</b>	<b>431,562</b>	—	—	—
Paul D. Keswick Executive Vice President, New Product Development	18,541	—	1.79	3/27/2013
	247,213	—	4.76	10/23/2013
	37,082	—	3.53	2/25/2015
	123,606	—	3.99	10/27/2016
<b>Total</b>	<b>426,442</b>	—	—	—
Christopher A. Seams Executive Vice President, Sales and Marketing	19,365	—	4.16	8/22/2013
	370,819	—	5.18	1/2/2014
	288,415	—	3.53	2/25/2015
	111,245	—	3.99	10/27/2016
<b>Total</b>	<b>789,844</b>	—	—	—
Dana C. Nazarian Executive Vice President, Memory Products Division	3,794	—	3.99	10/27/2016
	25,494	1,889	4.91	3/8/2016
<b>Total</b>	<b>29,288</b>	<b>1,889</b>	—	—
<b>Total All NEOs</b>	<b>5,820,717</b>	<b>1,889</b>	—	—

We are asking our stockholders to view our share repurchase programs as a stockholder friendly and value-creating event, and to not allow this positive event to unduly limit the Company's ability to continue to perform stock buybacks and to hire and retain skilled, motivated employees.

#### Equity Compensation Awards Allow us to Implement our Philosophy of Pay-For-Performance

Our employee equity granting practices are significantly directed at using pay-for-performance. Since 2007, nearly one third of the shares granted to all of our employees and 95% of our equity awards granted to our executive officers vest only based upon achieving performance milestones.

## Overhang Reduction

Overhang is another method of calculating the dilutive effect of equity compensation programs, similar to SVT. We have significantly reduced the overhang caused by the spin-off of SunPower Corporation (the “SunPower spin-off” or “spin-off”). The SunPower spin-off gave rise to an immediate and significant increase in outstanding employee equity awards. Prior to the day of the SunPower spin-off, our overhang (expressed as employee equity grants available for grant or outstanding as a percentage of common stock outstanding plus equity grants available for grant or outstanding) was approximately 15%. This was our lowest overhang level in over a decade. Immediately after the SunPower spin-off on September 29, 2008, our overhang increased to approximately 45%. This number has decreased every quarter and now is approximately 24%. The Overhang Trend chart below depicts our overhang as it existed at the end of 2006 through the current period, December 30, 2012. As you can see, throughout 2008, our overhang percent trended down until the fourth quarter of 2008, the quarter in which SunPower was spun-off. As a direct result of equity awards adjustments made due to the spin-off, our overhang increased dramatically to 45% and has trended downward ever since to approximately 24% as of December 30, 2012.

Overhang Trend (%)

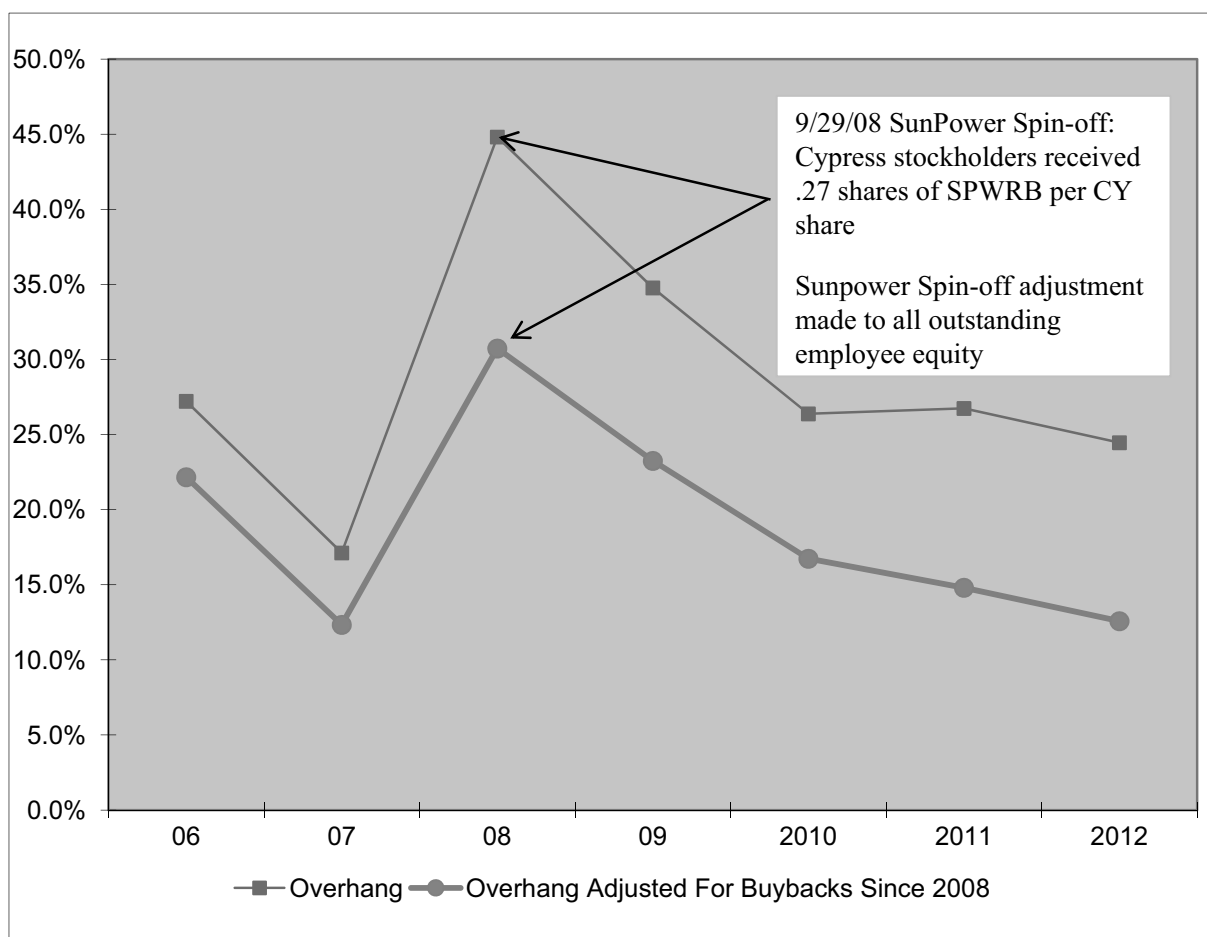

We have taken the following actions to reduce overhang:

- We have executed our business plan strategies to drive our stock price higher and encourage employees to exercise stock options.



- We have reduced our number of shares available to grant to new hires and annual awards on two separate occasions.
- We have predominately issued restricted stock units rather than stock options, which tends to reduce our overhang.
- We allowed our 1999 Stock Option Plan and its remaining share pool to expire with unissued awards.

We intend to remain focused on reducing overhang and will continue to take aggressive steps towards our goal.

### Plan Benefits

The number of awards that an employee or consultant may receive under the Plan is in the discretion of the Committee and therefore cannot be determined in advance.

The following table sets forth (a) the maximum number of shares subject to restricted stock units or performance share awards that could have been earned in fiscal year 2012, (b) the maximum number of shares subject to options granted under the Plan during fiscal year 2012, and (c) the fair market value on the grant date.

Name and Position	Maximum Number of Shares Subject to Restricted Stock Unit or Performance Share Awards	Maximum Number of Shares Subject to Stock Option Awards	Grant Date Fair Value (\$)
T.J. Rodgers, CEO	576,831	—	9,194,686
Brad W. Buss, Executive Vice President Finance and Administration, CFO	360,519	—	5,746,673
Paul D. Keswick, Executive Vice President New Product Development	288,416	—	4,597,351
Dana C. Nazarian, Executive Vice President Memory Products Division	250,164	—	3,987,614
Christopher A. Seams, Executive Vice President Sales and Marketing	288,416	—	4,597,351
All executive officers, including the Named Executive Officers above, as a group	2,889,703	—	45,671,294
All directors who are not executive officers, as a group	89,481	—	1,224,995
All employees who are not executive officers, as a group	2,398,569	3,680,194	39,923,786

### Summary

Equity awards are a key component of our overall compensation strategy, contributing a significant portion to our employees' total compensation. We are asking our stockholders to allow us to continue to hire and retain skilled, motivated employees through our competitive employee performance-based equity program, and to not allow the impact that the SunPower spin-off and aggressive stock repurchase programs have had on our SVT calculations to negatively influence any decision regarding this proposal. We have continued to deliver strong returns to our stockholders and approval of this proposal is important so that we may continue to do so in the future. The Company has placed a great degree of emphasis on reducing its employee equity overhang and has significantly done so, reducing it from 45% in 2008 to approximately 24% in 2012.

**Required Vote**

The affirmative vote of the holders of a majority of the common stock present or represented at the meeting is required to approve the adoption of the Amended Plan and approve its material terms.

- THE BOARD OF DIRECTORS UNANIMOUSLY RECOMMENDS A VOTE “FOR” THE APPROVAL OF ADOPTION OF THE AMENDED PLAN AND APPROVAL OF ITS MATERIAL TERMS.**

## PROPOSAL FIVE

### APPROVAL OF THE AMENDED AND RESTATED EMPLOYEE STOCK PURCHASE PLAN

#### Background

This is a proposal to approve the amendment and restatement of our Employee Stock Purchase Plan (the “ESPP”) to:

- extend the term of the ESPP by ten years,
- provide for participation by non-US employees, and
- reduce the maximum number of shares that may be used to annually replenish the ESPP share reserve from 12.4 million to two million.

If this proposal is not approved by our stockholders, the ESPP will expire on May 1, 2013. We would expect to be at a competitive disadvantage and would be forced to consider some type of additional cash profit sharing plan to make up for the loss of this important benefit. The cost of such programs could be in the range of approximately \$10 million to \$12 million dollars, which would not provide the alignment with our stockholders that the ESPP provides.

Our Board of Directors (the “Board”) approved an amendment and restatement of the ESPP, subject to obtaining stockholder approval, which will extend the term of the ESPP for an additional ten years from the date of our 2013 Annual Meeting, provide participation by non-US employees, and reduce the maximum number of shares that may be used annually to replenish the ESPP share reserve from 12.4 million to two million.

Approval of this proposal requires the affirmative vote of the holders of a majority of the shares of our common stock that are present in person or by proxy and entitled to vote at our 2013 Annual Meeting.

Excluding Mr. Rodgers who is not eligible to participate by virtue of his greater than 5% share ownership, our named executive officers and employees have an interest in this proposal because they are eligible to participate in the ESPP.

#### Purposes and Effects of the Proposal

Encouraging employees to acquire equity ownership in the Company assures a closer alignment of the interests of participating employees in the ESPP with those of the Company’s stockholders. The proposed adjustments to the ESPP will enable the Company to continue to use the ESPP as a valuable tool for attracting and retaining key personnel throughout the world and to align the interests of ESPP participants with those of the Company’s stockholders. The ESPP is a key recruiting and retention tool for our average employee, especially given that we do not provide any matching program for our 401(k) plan like many of our competitors do, nor do we provide any defined benefit pension plans in the majority of locations including the United States.

#### Description of Employee Qualified Stock Purchase Plan

The following is a summary of the principal features of the ESPP and its operation. This summary is qualified in its entirety by reference to the ESPP as set forth in [Appendix B](#).

##### *Purpose*

The purpose of the ESPP is to provide employees of the Company and its designated subsidiaries with an opportunity to purchase common stock of the Company through accumulated payroll deductions or other contributions. The ESPP is intended to qualify as an employee stock purchase plan under Section 423 of the Internal Revenue Code of 1986, as amended (the “IRS Code”). The Company, however, does not guarantee that

the ESPP so qualifies. The ESPP, as amended and restated, would also have a non-423 component, to allow for non-US participants to participate in the ESPP who may otherwise be ineligible given the restrictions of the IRS Code.

#### *Term of ESPP*

The ESPP will expire on May 1, 2013 unless sooner terminated pursuant to the provisions of the ESPP. If our stockholders approve this proposal, the plan will continue until May 10, 2023.

#### *Eligibility*

Any employee who is customarily employed for at least twenty (20) hours per week by the Company or its subsidiaries and that is designated as eligible by the Board as eligible to participate in the ESPP is eligible to participate in the ESPP. No employee who owns stock or holds outstanding options to purchase stock possessing five percent (5%) or more of the total combined voting power or value of all classes of stock of the Company or of any subsidiary of the Company may participate. As such our CEO is not allowed to participate due to his significant ownership position in the Company. Moreover, no employee may participate to the extent that they may purchase stock under all employee stock purchase plans of the Company and its subsidiaries at a rate which exceeds \$25,000 of fair market value (determined on the first day of any offering period) in any calendar year. As of March 1, 2013, the Plan had approximately 3,500 eligible participants.

#### *Shares Available for Issuance*

As of February 15, 2013, there are approximately 4.2 million shares of Company common stock which are available for issuance under the ESPP. Currently, the ESPP provides for an automatic annual increase equal to the lesser of (i) 12,360,660 shares, (ii) .75% of Issued Shares plus any shares reacquired by the Company during the fiscal year, or (iii) a lesser amount determined by the Board. In the case of (i) above, we plan to reduce the number of shares from 12,360,660 to 2,000,000 shares.

#### *Offering Period*

The ESPP is implemented by consecutive and overlapping eighteen (18) month offering periods (“Offering Periods”) beginning approximately every six months. New Offering Periods commence on the first trading day on or after December 31 and June 30 each year, or on such other date that the Board may determine. The Board has the power to change the duration of Offering Periods without stockholder approval if such change is announced at least fifteen (15) days prior to the scheduled beginning of the first Offering Period to be affected.

#### *Participation*

Eligible employees may participate in the ESPP by completing a subscription agreement authorizing payroll deductions pursuant to the ESPP. Payroll deductions may not be less than two percent (2%) and may not exceed ten percent (10%) of the participant’s aggregate compensation during the Offering Period. A participant may discontinue participation in the ESPP or decrease or increase the rate of payroll deductions during an Offering Period pursuant to the ESPP but may not change the rate or amount of payroll deductions more than two times in any one calendar year. In order to comply with Section 423(b)(8) of the Internal Revenue Code and eligibility limitations pursuant to the ESPP, a participant’s payroll deductions may be decreased to zero percent (0%).

#### *Option Grant*

The Internal Revenue Service views participants in our ESPP as receiving options. The price per share subject to the option is the lower of (i) eighty-five percent (85%) of the fair market value of a share of our common stock on the first day of the eighteen-month Offering Period, or (ii) eighty-five percent (85%) of the fair

market value of a share of our common stock on the purchase date. On the first day of each offering period, each eligible employee participant is granted an option to purchase a number of shares of our common stock determined by dividing the employee's payroll deductions accumulated prior to the purchase date by the lower of (i) eighty-five percent (85%) of the fair market value of a share of our common stock on the first day of the Offering Period, or (ii) eighty-five percent (85%) of the fair market value of our common stock on the purchase date. The maximum number of shares subject to each option is determined by dividing \$25,000 by the fair market value of a share of our common stock on the first day of the Offering Period, and other limitations pursuant to the ESPP.

#### *Option Exercise*

Unless a participant withdraws from the ESPP, a participant's option for the purchase of shares is exercised automatically on each purchase date. The maximum number of full shares subject to option is purchased for the participant at the applicable option price using the accumulated payroll deductions in his or her account. During a participant's lifetime, the participant's option to purchase shares under the ESPP is exercisable only by that participant.

#### *Automatic Transfer to Low Price Offering Period*

In the event that the fair market value of our common stock is lower on a purchase date than it was on the first day of the Offering Period, all employees participating in the ESPP on the purchase date are deemed to have withdrawn from the Offering Period immediately after exercise of their option and to have enrolled as participants in the newly commencing Offering Period. A participant may elect to remain in the previous Offering Period by filing a written statement pursuant to the ESPP and prior to the automatic change.

#### *Withdrawal; Termination of Employment*

A participant may withdraw all, but not less than all, payroll deductions credited to his or her account and not yet used to exercise the option at any time by written notice to the Company. If a participant withdraws from an Offering Period, no further payroll deductions will be made during the Offering Period under the ESPP and payroll deductions will not resume at the beginning of the succeeding Offering Period.

If a participant fails to remain as our employee or ceases to meet the ESPP eligibility requirements, he or she is deemed to have elected to withdraw from the ESPP. Withdrawal from an Offering Period has no effect upon a participant's eligibility to participate in succeeding Offering Periods which commence after termination of the Offering Period from which the participant withdrew, or in any similar plan which we may thereafter adopt.

Upon termination of the participant's continuous status as an employee prior to a purchase date, payroll deductions credited to the participant's account during the Offering Period but not yet used to exercise the option will be returned to the participant or, in the case of his or her death, to the person or persons entitled thereto, and the participant's option will automatically terminate.

#### *Adjustments Upon Changes in Capitalization & Certain Transactions*

Any increase or decrease in the number of issued shares of our common stock resulting from a stock split, stock spin-off or payment of a stock dividend, or any other increase or decrease in the number of shares of our common stock effected without the participant receiving financial consideration proportionately automatically adjusts:

- the number of shares of common stock covered by each ESPP option,
- the number of shares of common stock which have been authorized for issuance under the ESPP, including the annual share replenishment limit of 2,000,000 shares (collectively, the "Reserves"), and
- the price per share of common stock covered by each ESPP option.

Any other issuance by us of shares of stock of any class, or securities convertible into shares of stock of any class, will affect the number or price of shares of common stock subject to an ESPP option.

In the event of proposed dissolution or liquidation of the Company, all Offering Periods terminate immediately prior to the consummation of such proposed action, unless the Board provides otherwise.

In the event of a proposed sale of all or substantially all of the assets of the Company, or the merger of the Company with or into another corporation, each option under the ESPP is assumed or an equivalent option is substituted by such successor corporation or a parent or subsidiary of such successor corporation, unless the Board determines to terminate and accelerate all Offering Periods.

The Board may adjust the Reserves, as well as the price per share of our common stock covered by each ESPP option, in the event that we undertake any reorganizations, recapitalizations, rights offerings or other increases or reductions of shares of our outstanding common stock, and in the event that we are consolidated with or merged into any other corporation.

#### *Amendment or Termination*

The ESPP administrator may at any time and for any reason terminate or amend the ESPP.

Without stockholder consent and without regard to whether any participant rights may be considered to have been adversely affected, the administrator is entitled to:

- change the Offering Periods,
- limit the frequency and/or number of changes in the amount withheld during an Offering Period,
- establish the exchange ratio applicable to amounts withheld in a currency other than U.S. dollars,
- permit payroll withholding in excess of the amount designated by a participant in order to adjust for delays or mistakes in our processing of properly completed withholding elections,
- accrue and pay a dividend during the Offering Period, and
- establish reasonable waiting and adjustment periods and/or accounting and crediting procedures to ensure that amounts applied toward the purchase of our common stock properly correspond with amounts withheld.

In the event the administrator determines that the ongoing operation of the ESPP may result in unfavorable financial accounting consequences, the administrator may, in its discretion and, to the extent necessary or desirable, modify or amend the ESPP to reduce or eliminate such accounting consequence including, but not limited to (i) increasing the purchase price for any Offering Period including an Offering Period underway at the time of the change in purchase price; (ii) shortening any Offering Period so that Offering Period ends on a new purchase date, including an Offering Period underway at the time of the administrator action; and (iii) allocating shares.

### Number of Shares Purchased by Certain Individuals and Groups

Given that the number of shares that may be purchased under the ESPP is determined, in part, on our common stock's market value at the beginning of an Offering Period and at the end of a purchase period (or upon a purchase date within an Offering Period) and given that participation in the ESPP is voluntary on the part of employees, the actual number of shares that may be purchased by any individual is not determinable. For illustrative purposes, the following table sets forth (a) the number of shares of our common stock that were purchased during fiscal year 2012 under the ESPP, and (b) the average price per share purchase price paid for such shares.

Name of Individual or Group	Number of Shares Purchased	Total Purchase Price (\$)	FMV at Offer Date (\$)
T.J. Rodgers	—	—	—
Brad W. Buss	1,476	16,761	19,719
Paul D. Keswick	706	8,017	9,432
Dana C. Nazarian	1,476	16,761	19,719
Christopher A. Seams	1,476	16,761	19,719
All executive officers, including the Named Executive Officers above, as a group	20,173	229,085	269,511
All directors who are not executive officers, as a group (1)	—	—	—
All employees who are not executive officers, as a group	667,290	7,577,745	8,914,994
<b>Total</b>	<b>687,463</b>	<b>7,806,830</b>	<b>9,184,506</b>

(1) Directors who are not employees of the Company are not eligible to participate in the ESPP.

### Tax Aspects

The tax consequences of the purchase of shares of common stock under the ESPP are as follows:

- An employee will not have taxable income when the shares of common stock are purchased, but the employee generally will have taxable income when the employee sells or otherwise disposes of ESPP shares.
- For shares that the employee does not dispose of until more than 24 months after the first day of the Offering Period and more than 12 months after the purchase date (the "Holding Period"), the gain of up to 15% of the market price of the stock on the date of the Offering Period is taxed as ordinary income. Any additional gain above that amount is taxed at long-term capital gain rates. If, after the Holding Period, the employee sells the stock for less than the purchase price, the difference is a long-term capital loss.
- The Company may deduct for federal income tax purposes an amount equal to the ordinary income an employee must recognize when he or she disposes of stock purchased under the ESPP within the Holding Period. The Company may not deduct any amount for shares disposed of after the Holding Period.

### Required Vote

The affirmative vote of the holders of a majority of the common stock present or represented at the meeting is required to approve the adoption of the ESPP and approve its material terms.

- THE BOARD OF DIRECTORS UNANIMOUSLY RECOMMENDS A VOTE "FOR" THE APPROVAL OF THE AMENDMENTS TO THE EMPLOYEE QUALIFIED STOCK PURCHASE PLAN.**

## SECURITIES AUTHORIZED FOR ISSUANCE UNDER EQUITY COMPENSATION PLANS

Information as of March 1, 2013 with respect to our compensation plans (including individual compensation arrangements) under which equity securities of Cypress are authorized for issuance, are aggregated in the table below, which includes:

- all compensation plans previously approved by security holders; and
- all compensation plans not previously approved by security holders.

### Equity Compensation Plan Information

Plan Category	Number of Securities to be Issued Upon Exercise of Outstanding Options, Warrants and Rights	Weighted Average Exercise Price of Outstanding Options, Warrants and Rights	Number of Securities Remaining Available for Future Issuance
Equity Compensation Plans Approved by Security Holders	21.6 <sup>1</sup>	\$7.61 <sup>2</sup>	24.5 <sup>3</sup>
Equity Compensation Plans Not Approved by Security Holders	4.9	\$5.92	—
Total	26.5	\$7.26 <sup>2</sup>	24.5

1. Includes 4.6 million shares of restricted stock units and restricted stock granted.
2. Excludes impact of 4.6 million shares of restricted stock units and restricted stock which have no exercise price.
3. Includes 19.2 million shares available for future issuance under Cypress's Amended and Restated 1994 Stock Plan. In addition, the amount includes 4.2 million shares available for future issuance under Cypress's employee stock purchase plan.



## CORPORATE GOVERNANCE

We continue to review our corporate governance policies and practices to ensure that they comply with the requirements or recommendations of various authorities in corporate governance and the best practices of other public companies. Our business, assets and operations are managed under the direction of our Board of Directors (“Board”). Members of our Board are kept informed of our business through discussions with our chief executive officer, our chief financial officer, our executive officers, our general counsel, other officers and employees of the Company and our independent auditors, and by reviewing materials provided to them and participating in meetings of the Board and its committees.

### Corporate Governance Changes in Fiscal Year 2012 and for Fiscal Year 2013

Because our Board is committed to strong and effective corporate governance, it regularly monitors our corporate governance policies and practices to ensure we meet or exceed the requirements of applicable laws, regulations and rules, and the NASDAQ listing standards.

Our Board continues to enhance our corporate governance policies and practices by enhancing its self-evaluation process. Specifically, the Company’s outside counsel engaged in one-on-one interviews with each director, allowing the directors to provide additional feedback on the Board’s performance and other matters related to the Company, as well as providing each director an opportunity to ask questions of outside counsel.

This change to our corporate governance policies and practices builds upon our solid corporate governance structure, which is exemplified by:

- a strong independent chairman of the Board whose duties and responsibilities are set forth in our Bylaws and has been that way for over 25 years.
- a Board that is up for election annually and has been for over 25 years.
- the charters of the Board’s committees, which clearly establish the roles and responsibilities of each of the committees.
- Board committees that are comprised of and chaired solely by independent directors.
- a Board that has unrestricted access to the Company’s management, employees and professional advisers.
- our annual director peer evaluation process.
- our non-employee and independent directors meeting regularly in executive session.
- a risk management program with specific responsibilities assigned to management, the Board, and the Board’s committees.
- a director orientation and continuing education program.
- our clear Code of Business Conduct and Ethics.
- our Corporate Governance Guidelines.
- our limitation on the use of perquisites for directors and executive officers.
- the Compensation Committee’s engagement of an independent compensation consultant.

Additional information regarding the above aspects of our corporate governance and the changes made or proposed by our Board for fiscal years 2012 and 2013 is provided in this Proxy Statement in the sections entitled “*Board Structure*” and “*Compensation Discussion and Analysis*.”

Our Corporate Governance Guidelines cover, among other topics:

- director independence;
- Board structure and composition;
- Board member nomination and eligibility requirements;
- Board leadership and executive sessions;
- limitations on other Board and committee service;
- committees of the Board;
- director responsibilities;
- Board and committee resources, including access to management and employees;
- director compensation;
- director orientation and ongoing education;
- succession planning; and
- Board and committee self-evaluations.

The Corporate Governance Guidelines and the Code of Business Conduct and Ethics are posted on our website at <http://investors.cypress.com/governance.cfm>.

## **Board Structure**

### *Determination of Independence*

The Board has adopted the definition of “independence” as described under the Sarbanes-Oxley Act of 2002 (“Sarbanes-Oxley”) Section 301, Rule 10A-3 under the Securities Exchange Act of 1934 (also referred to as the “Exchange Act”) and NASDAQ Rule 5605. In order to make a determination of independence of a director as required by our Corporate Governance Guidelines and the rules of the SEC, the Board determines whether a director or a director nominee has a material relationship with Cypress (either directly or indirectly as a partner, stockholder or officer of an organization that has a relationship with Cypress). Each director or director nominee completed a questionnaire, with questions tailored to the rules of NASDAQ, as well as the securities law requirements for independence. On the basis of the questionnaires completed and returned by each director, the Board determined that each of Messrs. Albrecht, Benhamou, Carney, Long, McCranie, Sherman, and van den Hoek is independent as determined under our Corporate Governance Guidelines, the rules of the NASDAQ and the Exchange Act. The Board determined that Mr. T.J. Rodgers, our president and chief executive officer, is not independent by virtue of his employment and position at Cypress. Apart from Mr. Rodgers, no other director has a relationship with Cypress other than through his membership on the Board and its committees. For an explanation of certain relationships between the Company and entities associated with our directors, please see “*Certain Relationships and Related Transactions.*”

### *Executive Sessions*

Executive sessions of independent directors are generally held before each regularly scheduled meeting of our Board and at other times as necessary and are chaired by the chairman of the Board. The Board’s policy is to hold executive sessions without the presence of management, including the chief executive officer, who is the only non-independent director. Except for the Operations Committee, the committees of the Board also generally meet in executive session at the end of each committee meeting. Members of the Operations Committee provide feedback to management following their attendance at the Company’s quarterly operations reviews.

### *Meeting Attendance*

In fiscal year 2012, our Board held four (4) regularly scheduled meetings. Every director attended all of the Board meetings, and at least 75% of the meetings of the committees of the Board on which the director served. Our independent directors met four (4) times in executive sessions during regularly scheduled Board meetings in fiscal year 2012. Mr. Benhamou presided over all executive sessions of our directors.

### *Board Size, Membership and Nomination*

The Nominating and Corporate Governance Committee is responsible for regularly assessing the size and composition of the Board and identifying exceptional director candidates in the event a vacancy occurs due to retirement or otherwise. The Nominating and Corporate Governance Committee uses a variety of methods for identifying and evaluating nominees for directorships, including requests to Board members and others for recommendations. Through the process of identification and evaluation, the Nominating and Corporate Governance Committee seeks to achieve a balance of experience, a broad knowledge base, integrity and capability on the Board.

Stockholders may recommend, with timely notice, individuals for the Nominating and Corporate Governance Committee to consider as potential director candidates by submitting their names and background to the Nominating and Corporate Governance Committee, c/o Corporate Secretary, Cypress Semiconductor Corporation, 198 Champion Court, San Jose, California 95134. The Nominating and Corporate Governance Committee will consider a recommendation only if appropriate biographical information and background materials are provided on a timely basis (see “*How and when may I submit proposals for consideration at next year’s annual meeting of stockholders, or nominate individuals to serve as directors for Cypress?*” in the Question and Answer section). No such stockholder recommendations were received for consideration at this year’s Annual Meeting of Stockholders.

The qualifications of recommended director candidates will be reviewed by the Nominating and Corporate Governance Committee in accordance with the criteria set forth in our Corporate Governance Guidelines and applicable securities laws, regardless of whether or not a potential candidate was recommended by a security holder, the Board, management or other parties. These criteria include the candidate’s skills, attributes, integrity, experience, commitment, diligence, conflicts of interest and the ability to act in the interest of all stockholders. The Nominating and Corporate Governance Committee does not assign specific weights to particular criteria and no particular criterion is necessarily applicable to all prospective nominees. Cypress believes that the skill set, backgrounds and qualifications of our directors, considered as a group, should provide a significant composite mix of experience, knowledge and abilities that will allow our Board to fulfill its responsibilities and act in the best interest of the Company’s stockholders.

The process followed by the Nominating and Corporate Governance Committee to identify and evaluate nominees includes meeting from time to time to evaluate biographical information and background material relating to potential candidates and if appropriate, conducting interviews of selected candidates by members of the Nominating and Corporate Governance Committee and the Board.

Assuming that appropriate biographical and background material are provided for candidates recommended by stockholders, the Nominating and Corporate Governance Committee will evaluate nominees by following substantially the same process, and applying substantially the same criteria, as for candidates submitted by Board members. Therefore, in recommending candidates for Board nomination, the Nominating and Corporate Governance Committee makes an assessment of each candidate, including candidates recommended by a stockholder, in light of the nomination criteria set forth in the Company’s Corporate Governance Guidelines. This assessment includes the evaluation of skills, the individual’s character and integrity, general business and semiconductor industry experience, direct experience in the management of a corporation that is a customer that buys from the semiconductor industry, leadership profile, strategic planning abilities and experience, aptitude in

accounting or finance, expertise in domestic and international markets, industry knowledge, understanding of relevant technologies, communications and interpersonal skills, and the ability and willingness to devote time as needed for Board services. The assessment is made in the context of the perceived needs of the Board from time to time.

The Board makes the final determination whether or not a stockholder-recommended candidate will be included as a director nominee for election in accordance with the criteria set forth in our Corporate Governance Guidelines. If the Board decides to nominate a stockholder-recommended candidate and recommends his or her election as a director by the stockholders, the name of the nominee will be included in Cypress's proxy statement and proxy card for the stockholders meeting at which his or her election is recommended.

#### *Communications from Stockholders and Other Interested Parties*

The Board will give appropriate attention to written communication on valid business issues that are submitted by stockholders and other interested parties, and will respond if and as appropriate. Absent unusual circumstances or as contemplated by committee charters, the chairman of our Board, with the assistance of the corporate secretary and internal legal counsel, is primarily responsible for monitoring communications from stockholders and other interested parties, and will provide copies or summaries of such communications to the other directors as the chairman considers appropriate. Communications will be forwarded to all directors if they relate to substantive matters and include suggestions or comments that the chairman of our Board considers to be important for the directors to know.

Stockholders and other interested parties who wish to send communications on any relevant business topic to the Board may do so by addressing such communication to the Chairman of the Board of Directors, c/o Corporate Secretary, Cypress Semiconductor Corporation, 198 Champion Court, San Jose, California, 95134 or sending an e-mail to CYBOD@cypress.com.

#### **Independent Director Contact**

Interested parties are able to make their concerns known to the non-management independent directors by electronic mail to CYBOD@cypress.com, or in writing addressed to the Chairman of the Board of Directors, c/o Corporate Secretary, Cypress Semiconductor Corporation, 198 Champion Court, San Jose, California 95134.

#### **Board Leadership Structure**

Eric A. Benhamou serves as chairman of our Board of Directors. Our Board's general policy, as stated in our Corporate Governance Guidelines, is that separate persons should hold positions of chairman of the Board and chief executive officer to enhance the Board's oversight of management. Our leadership structure enhances accountability of our chief executive officer to the Board, provides a balance of power on our Board and encourages thoughtful decision-making. We also separate the roles in recognition of the differences in roles. While the chief executive officer is responsible for the day-to-day leadership of the Company and the setting of strategic direction, the chairman provides guidance to the Board, sets the agenda for Board meetings and presides over the meetings of the full Board and the meetings of the Board's non-management directors. The chairman also provides performance feedback on behalf of the Board to our chief executive officer.

#### **Stock Ownership Requirements**

##### *Directors*

The Board has adopted stock ownership requirements to more closely align the interests of our directors and Named Executive Officers with those of our stockholders. The requirements provide that each non-employee director must own at least 20,000 shares of common stock of the Company. New directors are required to meet the requirement within three years of their appointment to the Board. All of our directors meet the stock ownership requirements, including Mr. Rodgers, our chief executive officer ("CEO"), who is an employee director.

### *Executive Officers*

Our CEO is required to own Company stock having a value of at least five times his annual base salary. Our Named Executive Officers, other than the CEO, are required to own Company stock at least three times their annual base salary. Individuals have five (5) years to meet the stock ownership requirement. If the stock ownership requirements are not met after five years, then the executive must hold all future shares that vest (net of taxes) until the stock ownership requirements are met. All of our Named Executive Officers met the stock ownership requirements as of the end of fiscal year 2012.

### **Board's Role in Risk Management Oversight**

The Board implements its risk oversight responsibilities primarily through its various committees, which receive management on the potentially significant risks the Company faces and how the Company seeks to control, manage and mitigate risk where appropriate. If the report is deemed significant, the chairman of the relevant committee reports on the committee discussion to the full Board during the committee reports portion of the next Board meeting. This enables the Board and its committees to coordinate the risk oversight role, particularly with respect to risk interrelationships. The Board's four committees (Audit, Compensation, Nominating and Corporate Governance and Operations) oversee those risks that are most appropriate to their charters. For example, the Audit Committee oversees risks related to internal controls, financial reporting, fraud, insurance, treasury, ethics and compliance, and litigation. The Audit Committee also oversees the activities of the Internal Audit Department that independently assesses, audits and monitors risk throughout the Company. The Compensation Committee oversees risks related to employees, compensation and use of Company equity. The Nominating and Governance Committee oversees risks related to corporate governance, executive management and business ethics. The Operations Committee, primarily through attending quarterly operations review meetings, oversees risks related to operations, supply chain and customers. In more limited cases, such as with risks of significant new business concepts and substantial entry into new markets, risk oversight is addressed as part of the full Board's engagement with our chief executive officer and management. Board members often discuss risk as a part of their review of the ongoing business, financial, and other activities of the Company. The Board also has overall responsibility for executive officer succession planning and reviews succession plans each year.

### **Risk Considerations in our Compensation Programs**

The Compensation Committee regularly considers the risks associated with our compensation policies and practices for employees, including those related to executive compensation programs. As part of the risk assessment, the Compensation Committee reviews our compensation programs to avoid certain design features that have been identified by experts as having the potential to encourage excessive risk-taking, such as compensation mix overly weighted toward annual incentives and unreasonable goals or thresholds. The Compensation Committee determined that, for all employees, our compensation programs should encourage our employees to take appropriate risks and encourage behaviors that enhance sustainable value creation in furtherance of the Company's business, but do not encourage excessive risk and accordingly are not reasonably likely to have a material adverse effect on the Company. The Compensation Committee believes that because we closely link our variable compensation with attaining performance objectives, we are encouraging our employees to make decisions that should result in positive short-term and long-term returns for our business and our stockholders without providing an incentive to take unnecessary risks. The Compensation Committee, with the assistance of Buck Consultants, LLC, an independent compensation consultant, intends to continue, on an ongoing basis, a process of thoroughly reviewing our compensation policies and programs to ensure that our compensation programs and risk mitigation strategies continue to discourage imprudent risk-taking activities.

## Board Committees

The Board has an Audit Committee, a Compensation Committee, a Nominating and Corporate Governance Committee, and an Operations Committee. The membership and functions of each committee in 2012 are described in the table below:

Director	Audit Committee	Compensation Committee	Nominating and Corporate Governance Committee	Operations Committee
T.J. Rodgers				
W. Steve Albrecht	Chairman			
Eric A. Benhamou	Member	Chairman		
Lloyd Carney	Member(1)	Member		
James R. Long		Member	Chairman	
J. Daniel McCranie			Member	Member
J. D. Sherman	Member			
Wilbert van den Hoek			Member	Member

- (1) Mr. Carney stepped down from the Audit Committee as of December 8, 2012 due to his new role as CEO of Brocade Communications Systems. Mr. McCranie will replace Mr. Carney for fiscal year 2013.

### *The Audit Committee*

The Audit Committee operates under a written charter adopted by our Board, and reviewed annually by the Audit Committee. The Audit Committee's charter was established in accordance with Exchange Act Section 3(a)(58)(A) and is available on our website at <http://investors.cypress.com/governance.cfm>.

The Board has determined that all the members of the Audit Committee are independent as independence is defined under the NASDAQ Marketplace Rule 5605. The Board determined that each member of the Audit Committee is financially literate and has accounting and/or related financial management expertise as required under the NASDAQ rules.

In fiscal year 2012, the Audit Committee consisted of Messrs. Albrecht, Benhamou, Carney and Sherman. The Audit Committee met eight (8) times in fiscal year 2012 and generally met in executive session independently with each of management, our internal audit team and PricewaterhouseCoopers, our certified public accounting firm.

Our Board designated Mr. Albrecht as the "audit committee financial expert" in accordance with the requirements of the SEC and NASDAQ rules.

The responsibilities of our Audit Committee and its activities during fiscal year 2012 are described in its charter and the Report of the Audit Committee contained in this Proxy Statement.

In discharging its duties, the Audit Committee:

- reviews and approves the scope of the annual audit.
- assists the Board in the oversight of the Company's compliance with legal and regulatory requirements.
- meets independently with our independent registered public accounting firm, internal auditors, and our senior management to identify, assess, manage and mitigate areas of risk for the Company.

- oversees and reviews the general scope of our accounting, financial reporting, annual audit and matters relating to internal control systems, as well as the results of the annual audit and review of interim financial statements, auditor performance, qualifications and independence issues, and the adequacy of the Audit Committee charter.
- prepares an Audit Committee report, as required by the SEC, to be included in the Company's annual proxy statement.
- pre-approves all fees proposed by or paid to our independent registered public accounting firm.
- reviews and provides input on the risk assessment processes in the Company, which will form the basis of the annual audit plan.
- oversees the implementation of the whistleblower policy.
- reviews SEC filings, earnings releases and other forms of significant investor communications.

#### *The Compensation Committee*

The Compensation Committee consists of Messrs. Benhamou, Carney, and Long. The Board has determined that the members of the Compensation Committee are independent as defined under NASDAQ rules. The Compensation Committee assists the Board with discharging its duties with respect to the formulation, implementation, review and modification of the compensation of our directors, officers and management, the preparation of the annual report on executive compensation for inclusion in our proxy statement and oversight of the Company's equity programs.

The Compensation Committee, through delegation by the Board, has overall responsibility for:

- establishing the specific performance objectives for our chief executive officer and subsequently evaluating his compensation based on achievement of those objectives.
- approval of performance objectives for our executive officers.
- formulating, implementing, reviewing, and modifying the compensation of the Company's directors and senior management.
- recommending to the Board for approval the Company's compensation plans, policies and programs.
- reviewing and approving the Company's Compensation Discussion and Analysis ("CD&A") for inclusion in the proxy statement.
- reviewing, revising in its discretion, and approving the annual merit and stock budgets for focal salary increases and equity grant awards for all eligible employees.
- reviewing the annual benefit changes made by the Company with respect to its employees.
- providing feedback to the chief executive officer on his performance.
- overseeing the stock plans of the Company and its subsidiary companies.
- overseeing and monitoring executive succession planning for the Company.
- periodic risk analysis of the Company's compensation policies and programs.

In discharging its duties, the Compensation Committee retains the services of compensation consultants in order to have independent, expert perspectives on matters related to executive compensation, Company and executive performance, equity plans and other issues. The Compensation Committee has the sole authority to determine the scope of services for these consultants and may terminate the consultants' services at any time. The fees of these consultants are paid by the Company. In fiscal year 2012, the Compensation Committee retained the services of Buck Consultants, LLC for various compensation-related services, including comparing our director compensation with the compensation of directors of our peer group companies.

No officer of the Company was present during discussions or deliberations regarding that officer's own compensation. Additionally, the Compensation Committee sometimes meets in executive session with its independent consultant to discuss various matters and formulate certain final decisions, including those regarding the performance and compensation of the chief executive officer.

The Compensation Committee held five (5) meetings during our 2012 fiscal year. The Report of the Compensation Committee is contained in this Proxy Statement. The charter for our Compensation Committee is posted on our website at <http://investors.cypress.com/governance.cfm>.

#### *The Nominating and Corporate Governance Committee*

The Nominating and Corporate Governance Committee consists of Messrs. Long, McCranie, and van den Hoek. The Board determined that the members of this Committee are independent as defined under the rules of NASDAQ. The purpose of the Nominating and Corporate Governance Committee is to:

- identify and evaluate individuals qualified to become Board members.
- recommend to the Board the persons to be nominated by the Board for election as directors at the annual meeting of stockholders, including any nomination of qualified individuals properly submitted by stockholders of the Company.
- develop, maintain and recommend to the Board a set of corporate governance principles.
- oversee the annual self-evaluation process of the Board and other Board committees.
- ensure that stockholder proposals, when approved, are implemented as approved.
- make recommendations to the Board on Board and Board committee membership.
- oversee the director's continuing education program.

The Nominating and Corporate Governance Committee is authorized to retain advisers and consultants and to compensate them for their services. The Nominating and Corporate Governance Committee did not retain any such advisers or consultants during fiscal year 2012.

The Nominating and Corporate Governance Committee held four (4) meetings during fiscal year 2012. The charter for our Nominating and Corporate Governance Committee is posted on our website at <http://investors.cypress.com/governance.cfm>.

#### *The Operations Committee*

The Operations Committee consists of Messrs. McCranie and van den Hoek. The purpose of the Operations Committee is to:

- review strategic proposals and provide advice and counsel to Cypress regarding daily business operations; and
- present to the management of the Company and the Board an independent assessment of Cypress's business operations and practices.

To discharge their responsibilities, members of the Operations Committee attend various quarterly operations reviews and provide advice and counsel to the Company's management. The charter of the Operations Committee is posted on our website at <http://investors.cypress.com/governance.cfm>.



Printed copies of the Corporate Governance Guidelines document, the Code of Business Conduct and Ethics, and the charters of the Audit Committee, the Compensation Committee, the Nominating and Corporate Governance Committee, and the Operations Committee are also available to any stockholder upon written request to:

Brad W. Buss  
Corporate Secretary  
Cypress Semiconductor Corporation  
198 Champion Court  
San Jose, California 95134

## COMPENSATION OF DIRECTORS

### *Non-Employee Director Cash Compensation*

Our non-employee directors are paid an annual fee for serving on the Board, plus additional fees based on their committee service. Such fees did not change in fiscal year 2012 and are expected to remain the same in fiscal year 2013. The table below shows the cash compensation for our non-employee Board members in fiscal year 2012.

<b>Position</b>	<b>2012 Annual Fees <sup>(1)</sup></b>
Non-employee director retainer	\$50,000
Board chairman	\$30,000
Audit Committee chairman	\$20,000
Audit Committee member	\$15,000
Compensation Committee chairman	\$15,000
Compensation Committee member	\$10,000
Nominating and Corporate Governance Committee chairman	\$5,000
Nominating and Corporate Governance Committee member	\$5,000
Operations Committee	\$2,500 for each of the Company's quarterly operations meetings attended

(1) Excluding the Operations Committee fees, which are paid per meeting.

In addition to the retainer and meeting fees described above, non-employee directors are also reimbursed for travel and other reasonable out-of-pocket expenses related to attendance at Board and committee meetings, business events on behalf of Cypress, and seminars and programs on subjects related to their responsibilities.

### *Non-Employee Director Equity Compensation*

Upon their initial appointment to the Board, each non-management director is granted an award, in an amount determined by the Administrator in its sole discretion, not to exceed a grant date fair value of \$750,000. Each outside director who was an outside director for a minimum of three months preceding the annual stockholder meeting will be granted an award for re-election in an amount determined by the administrator in its sole discretion, not to exceed a grant date fair value of \$500,000. Such awards are subject to the limitations set forth in the Company's stock plan and shall vest and be payable and shall be subject to such other terms and conditions as may be determined by the Administrator.

### *Non-Employee Director Stock Ownership Requirement*

The Board has established a Non-Employee Director Ownership Requirement pursuant to which non-employee directors are required to own 20,000 shares of common stock of the Company. New directors are required to meet the requirement within three years of their appointment. All directors meet the stock ownership requirements. For more information about the Company's stock ownership requirements, please refer to "Corporate Governance — Stock Ownership Requirements."

## DIRECTOR COMPENSATION

**Fiscal Year Ended December 30, 2012**

Name	Year	Fees Earned or Paid in Cash (\$)	Stock Awards (\$) <sup>1</sup>	Option Awards (\$) <sup>2</sup>	Non-Equity Incentive Plan Compensation (\$)	Change in Pension Value and Nonqualified Deferred Compensation Earnings (\$)	All Other Compensation (\$)	Total (\$)
W. Steve Albrecht <sup>3</sup>	2012	85,000	174,999	-	-	-	0	259,999
Eric A. Benhamou <sup>4</sup>	2012	120,000	174,999	-	-	-	0	294,999
Lloyd Carney <sup>5</sup>	2012	75,000	174,999	-	-	-	0	249,999
James R. Long <sup>6</sup>	2012	70,000	174,999	-	-	-	0	244,999
J. Daniel McCranie <sup>7</sup>	2012	90,000	174,999	-	-	-	0	264,999
J. D. Sherman <sup>8</sup>	2012	65,000	174,999	-	-	-	0	239,999
Wilbert van den Hoek <sup>9</sup>	2012	166,250	174,999	-	-	-	0	341,249

1. The value reported in the “Stock Awards” column represents the aggregate grant date fair value of awards granted in fiscal year 2012, as determined pursuant to FASB Accounting Standards Codification 718 (also referred to as “ASC 718”). The amount shown for each director reflects the grant date fair value of a grant for 12,783 shares made on May 11, 2012. The directors had the following number of unvested restricted stock units at the end of fiscal year 2012: each of Messrs. Albrecht, Benhamou, Carney, Long and McCranie, 8,241 shares; Mr. Sherman, 14,932 shares; and Mr. van den Hoek, 16,004 shares.
2. No stock option awards were granted to our directors in fiscal year 2012. The following aggregate number of option awards was outstanding at the end of fiscal year 2012: Mr. Albrecht, 92,018 shares; Mr. Benhamou, 164,808 shares; Mr. Carney, 37,808 shares; Mr. Long, 157,606 shares; and each of Messrs. McCranie, Sherman and van den Hoek, 0 shares.
3. Amount includes \$50,000 Board retainer fee and \$35,000 Audit Committee chairman fee.
4. Amount includes \$50,000 Board retainer fee, \$30,000 for Board chairmanship, \$15,000 Audit Committee member fee, and \$25,000 Compensation Committee chairman fee.
5. Amount includes \$50,000 Board retainer fee, \$15,000 Audit Committee member fee, and \$10,000 Compensation Committee member fee.
6. Amount includes \$50,000 Board retainer fee, \$10,000 Compensation Committee member fee, and \$10,000 Nominating and Corporate Governance Committee chairman fee.
7. Amount includes \$50,000 Board retainer fee, \$5,000 Nominating and Corporate Committee member fee, and \$35,000 for attendance at our operations review meetings as member of the Operations Committee.
8. Amount includes \$50,000 Board retainer fee, and \$15,000 Audit Committee member fee.
9. Amount includes \$50,000 Board retainer fee, \$5,000 Nominating and Corporate Committee member fee, and \$111,250 for attendance at our operations review meetings as member of the Operations Committee.

## REPORT OF THE AUDIT COMMITTEE OF THE BOARD OF DIRECTORS

The Audit Committee of Cypress's Board of Directors serves as the representative of the Board of Directors with respect to its oversight of:

- Cypress's accounting and financial reporting processes and the audit of Cypress's financial statements.
- the integrity of Cypress's financial statements.
- Cypress's internal controls and the audit of management's assessment of the effectiveness of internal control over financial reporting.
- Cypress's compliance with legal and regulatory requirements.
- the independent registered public accounting firm's appointment, qualifications and independence.
- the performance of Cypress's internal audit function.

The Audit Committee also reviews the performance of Cypress's independent registered public accounting firm, PricewaterhouseCoopers LLP, in the annual audit of financial statements and internal control over financial reporting and in assignments unrelated to the audit, and reviews the independent registered public accounting firm's fees.

The Audit Committee provides the Board such information and materials as it may deem necessary to make the Board aware of financial matters requiring the attention of the Board. The Audit Committee reviews the Company's financial disclosures and meets privately, outside the presence of our management, with our independent registered public accounting firm and our internal auditors to discuss our internal accounting control policies and procedures. In fulfilling its oversight responsibilities, the Audit Committee reviewed the audited financial statements in our Annual Report on Form 10-K for our fiscal year ended December 30, 2012, with management including a discussion of the quality and substance of the accounting principles, the reasonableness of significant judgments, and the clarity of disclosures in the financial statements. In addition, the Audit Committee reviewed the results of management's assessment of the effectiveness of Cypress's internal control over financial reporting as of December 30, 2012. The Audit Committee reports on these meetings to our Board.

The charter of the Audit Committee is posted on our website at <http://investors.cypress.com/governance.cfm>.

Cypress's management has primary responsibility for preparing Cypress's financial statements and for its financial reporting process. In addition, management is responsible for establishing and maintaining adequate internal control over financial reporting. Cypress's independent registered public accounting firm is responsible for expressing an opinion on the conformity of Cypress's financial statements to generally accepted accounting principles and on the effectiveness of Cypress's internal controls over financial reporting.

The Audit Committee hereby reports as follows:

(1) The Audit Committee has reviewed and discussed the audited financial statements for fiscal year 2012 with Cypress's management.

(2) The Audit Committee has discussed with PricewaterhouseCoopers LLP, the independent registered public accounting firm for Cypress, the matters required to be discussed by the Statement on Audit Standards No. 61, as amended (AICPA, *Professional Standards*, Vol. 1. AU section 380), as adopted by the Public Company Accounting Oversight Board in Rule 3200T.

(3) The Audit Committee has received the written disclosures and the letter from PricewaterhouseCoopers LLP for Cypress as required by applicable requirements of the Public Company Accounting Oversight Board regarding PricewaterhouseCoopers LLP's communications with the Audit Committee concerning independence, and has discussed with PricewaterhouseCoopers LLP its independence.

Based on the review and discussion referred to in items (1) through (3) above, the Audit Committee recommended to Cypress's Board of Directors and the Board approved that the Company's audited financial statements be included in Cypress's Annual Report on Form 10-K for the fiscal year ended December 30, 2012 for filing with the SEC. The Audit Committee also recommended the reappointment of PricewaterhouseCoopers LLP as Cypress's independent registered public accounting firm for fiscal year 2012.

Each member of the Audit Committee is independent as defined under the NASDAQ listing standards.

AUDIT COMMITTEE OF THE BOARD OF DIRECTORS

W. Steve Albrecht, Chairman  
Eric A. Benhamou  
Lloyd Carney  
J. D. Sherman

## SECURITY OWNERSHIP OF CERTAIN BENEFICIAL OWNERS AND MANAGEMENT

The following table sets forth certain information regarding common stock beneficially owned as of February 1, 2013 (which includes any equity shares that will vest within 60 days thereof) as well as those shares that were actually owned as of February 1, 2013 for:

- each of our directors.
- our chief executive officer, our chief financial officer and each of the three other most highly compensated individuals who served as our executive officers at fiscal year-end (the “Named Executive Officers”).
- all individuals who served as directors or executive officers at fiscal year-end as a group.
- each person (including any “group” as that term is used in Section 13(d)(3) of the Exchange Act of 1934, as amended) who is known by us to own beneficially more than 5% of our common stock.

<b>Directors, Officers and 5% Stockholders</b>	<b>Shares Beneficially Owned<sup>1</sup></b>		<b>Shares Actually Owned<sup>2</sup></b>
		<b>Percent<sup>3</sup></b>	
<b>Directors</b>			
T.J. Rodgers	12,110,074 <sup>4</sup>	7.96%	7,966,493 <sup>5</sup>
W. Steve Albrecht	197,176 <sup>6</sup>	*	105,158 <sup>7</sup>
Eric A. Benhamou	309,646 <sup>8</sup>	*	144,838 <sup>9</sup>
Lloyd Carney	147,966 <sup>10</sup>	*	110,158 <sup>11</sup>
James R. Long	294,744 <sup>12</sup>	*	137,138 <sup>13</sup>
J. Daniel McCranie	81,890	*	81,890
J. D. Sherman	69,647	*	69,647
Wilbert van den Hoek	22,784	*	22,784
<b>Named Executive Officers</b>			
Brad W. Buss	1,323,784 <sup>14</sup>	*	892,222 <sup>15</sup>
Paul D. Keswick	1,085,688 <sup>16</sup>	*	659,246 <sup>17</sup>
Christopher A. Seams	1,530,556 <sup>18</sup>	1.01%	740,712 <sup>19</sup>
Dana C. Nazarian	199,424 <sup>20</sup>	*	168,247 <sup>21</sup>
All directors and executive officers at fiscal year-end as a group	17,737,565 <sup>22</sup>	11.65%	11,392,712 <sup>23</sup>
<b>5% Stockholders</b>			
FMR LLC <sup>24</sup> 82 Devonshire Street Boston, Massachusetts 02109	21,846,114	15.28%	—
The Vanguard Group, Inc. <sup>25</sup> 100 Vanguard Blvd. Malvern, PA 19355	7,314,371	5.11%	—
Citadel Investment Group II, L.L.C. <sup>26</sup> 131 S. Dearborn Street, 32nd Floor Chicago, IL 60603	7,941,372	5.21%	—

\* Less than 1%. See footnotes on the next page.

1. For each person and group included in this column, beneficially owned shares includes the number of shares of common stock that such person or group had the right to acquire within 60 days after February 1, 2013.
2. For each person and group included in this column, shares owned by such person or group excludes the number of shares of common stock that such person or group had the right to acquire within 60 days after February 1, 2013.
3. For each person and group included in this table, percentage ownership is calculated by dividing the number of shares beneficially owned by such person or group by the sum of 145,875,765 shares of common stock outstanding as of February 1, 2013, plus the number of shares of common stock that such person or group had the right to acquire within 60 days after February 1, 2013.
4. Includes 7,546,493 shares of common stock held by Mr. Rodgers and options to purchase 4,143,581 shares of common stock, which are exercisable within 60 days of February 1, 2013. Also includes 420,000 shares of common stock held indirectly on February 1, 2013.
5. Includes 7,546,493 shares of common stock held by Mr. Rodgers and excludes options to purchase 4,143,581 shares of common stock, which are exercisable within 60 days of February 1, 2013. Also includes 420,000 shares of common stock held indirectly on February 1, 2013.
6. Represents 105,158 shares of common stock held directly by Mr. Albrecht and options to purchase 92,018 shares of common stock, which are exercisable within 60 days of February 1, 2013.
7. Represents 105,158 shares of common stock held directly by Mr. Albrecht and excludes options to purchase 92,018 shares of common stock, which are exercisable within 60 days of February 1, 2013.
8. Represents 144,838 shares of common stock held directly by Mr. Benhamou and options to purchase 164,808 shares of common stock, which are exercisable within 60 days of February 1, 2013.
9. Represents 144,838 shares of common stock held directly by Mr. Benhamou and excludes options to purchase 164,808 shares of common stock, which are exercisable within 60 days of February 1, 2013.
10. Represents 110,158 shares of common stock held directly by Mr. Carney, and options to purchase 37,808 shares of common stock, which are exercisable within 60 days of February 1, 2013.
11. Represents 110,158 shares of common stock held directly by Mr. Carney, and excludes options to purchase 37,808 shares of common stock, which are exercisable within 60 days of February 1, 2013.
12. Represents 137,138 shares of common stock held directly by Mr. Long and options to purchase 157,606 shares of common stock, which are exercisable within 60 days of February 1, 2013.
13. Represents 137,138 shares of common stock held directly by Mr. Long and excludes options to purchase 157,606 shares of common stock, which are exercisable within 60 days of February 1, 2013.
14. Represents 892,222 shares of common stock held directly by Mr. Buss and options to purchase 431,562 shares of common stock, which are exercisable within 60 days of February 1, 2013.
15. Represents 892,222 shares of common stock held directly by Mr. Buss and excludes options to purchase 431,562 shares of common stock, which are exercisable within 60 days of February 1, 2013.
16. Represents 659,246 shares of common stock directly held by Mr. Keswick and options to purchase 426,442 shares of common stock, which are exercisable within 60 days of February 1, 2013.
17. Represents 659,246 shares of common stock directly held by Mr. Keswick and excludes options to purchase 426,442 shares of common stock, which are exercisable within 60 days of February 1, 2013.
18. Represents 740,712 shares of common stock held directly by Mr. Seams and options to purchase 789,844 shares of common stock, which are exercisable within 60 days of February 1, 2013.
19. Represents 740,712 shares of common stock held directly by Mr. Seams and excludes options to purchase 789,844 shares of common stock, which are exercisable within 60 days of February 1, 2013.

20. Represents 168,247 shares of common stock held directly by Mr. Nazarian and options to purchase 31,177 shares of common stock, which are exercisable within 60 days of February 1, 2013.
21. Represents 168,247 shares of common stock held directly by Mr. Nazarian and excludes options to purchase 31,177 shares of common stock, which are exercisable within 60 days of February 1, 2013.
22. Includes 11,392,712 shares of common stock held directly or indirectly by our directors, executive officers, and their family members. Also includes options to purchase 6,344,853 shares of common stock exercisable as of February 1, 2013.
23. Includes 11,392,712 shares of common stock held directly or indirectly by our directors, executive officers, and their family members. Excludes options to purchase 6,344,853 shares of common stock exercisable as of February 1, 2013.
24. The ownership information set forth in the table is based on information contained in a statement on Schedule 13G/A filed on February 13, 2013, with the SEC by FMR LLC. FMR LLC has sole voting power with respect to 1,427 shares and sole dispositive power with respect to 21,846,114 shares of common stock.
25. The ownership information set forth in the table is based on information contained in a statement on Schedule 13G filed on February 11, 2013, with the SEC by The Vanguard Group, Inc. The Vanguard Group, Inc. has sole voting power with respect to 102,712 shares, sole dispositive power with respect to 7,218,559 shares and shared dispositive power with respect to 95,812 shares.
26. The ownership information set forth in the table is based on information contained in a statement on Schedule 13G filed on June 18, 2012, with the SEC by Citadel Advisors LLC, Citadel Holdings II LP, Citadel Investment Group II, L.L.C. and Mr. Kenneth Griffin. Citadel Investment Group II, L.L.C. has shared voting power and share dispositive power with respect to all 7,941,372 shares.



## EXECUTIVE COMPENSATION

### Compensation Discussion and Analysis (“CD&A”)

#### Introduction

This section describes the Company’s compensation philosophies, objectives and programs as well as the compensation-related actions taken in fiscal year 2012 for our chief executive officer, our chief financial officer and our three most highly compensated executive officers employed at the end of fiscal year 2012. These executives are referred to in this section as our Named Executive Officers or NEOs. Our NEOs for fiscal year 2012 were:

- T.J. Rodgers — President and Chief Executive Officer;
- Brad W. Buss — Chief Financial Officer and Executive Vice President, Finance and Administration;
- Paul D. Keswick — Executive Vice President, New Product Development;
- Christopher A. Seams — Executive Vice President, Sales and Marketing Operations; and
- Dana C. Nazarian — Executive Vice President, Memory Products Division.

In this CD&A section, the terms “we,” “our,” and “us” refer to management, the Company and sometimes as applicable, the Compensation Committee (“Committee”) of the Company’s Board of Directors (the “Board”).

#### Compensation Philosophy and Objectives

The Company’s philosophy is to target total Named Executive Officer compensation at approximately the 50<sup>th</sup> percentile among our named peer group companies. A large component of that total compensation is comprised of 100% at-risk incentive cash compensation and equity compensation such that in years when our executives have high performance, they may be paid above the target and in years when they have low performance, they may be paid below the target.

Our executive officers earn their variable, performance-based compensation under our incentive cash compensation and equity programs. The performance targets under these programs are challenging and pre-determined both at the corporate level, through corporate goals, and at a personal level through individual goals set for each applicable period (i.e., each quarter, plus annual goals). The payout may be robust or meager depending on the level of goal achievement. If the goals are achieved at a high level, the total compensation for our Named Executive Officers could approximate the 75<sup>th</sup> percentile or more of the total compensation for similar positions in our peer group companies. Conversely, if the performance targets are not achieved under our performance-based cash or equity compensation programs, compensation for our Named Executive Officers is significantly diminished and we would expect that it would fall below the 50<sup>th</sup> percentile (depending on the extent to which the actual performance falls short of the target).

The compensation programs for our executives are designed to achieve the following objectives:

*Attract and Retain Top Talent* — to compete effectively for the highest quality of people who will determine our long-term success. We have structured our executive compensation program to be competitive with compensation paid by companies in the same market for executive talent, which may include public and private companies. This is very important, especially in the Silicon Valley area. To ensure we remain competitive, we generally administer an annual focal review process to evaluate the current level of compensation and equity for each employee (including our executive officers) is adequate and make adjustments based on merit. By using a ranking system in the annual focal review, we reinforce the direct and meaningful link between individual performance and rewards. Therefore, the higher an executive officer is ranked, the more likely they will receive a greater percentage increase in both equity and cash compensation.

*Pay-for-Performance* — to align executive compensation with Company, business unit and individual performance on both a short-term and long-term basis. Our NEOs' total direct compensation is heavily weighted towards variable compensation, which includes quarterly and annual incentive cash bonuses and performance-based restricted stock units. None of our NEO's have been granted any time or service-based stock awards while serving as a NEO for over five years. This aligns executive compensation with stockholder interests by tying a significant majority of total direct compensation to achieving performance goals. Both our variable cash and equity incentive awards are structured around very stringent, aggressive and measureable goals and by design are very rewarding when the goals are achieved and if the goals are not achieved, no payout is earned. As shown in the following chart, the performance-based incentives constitute by far the largest portion of potential compensation for the Named Executive Officers:

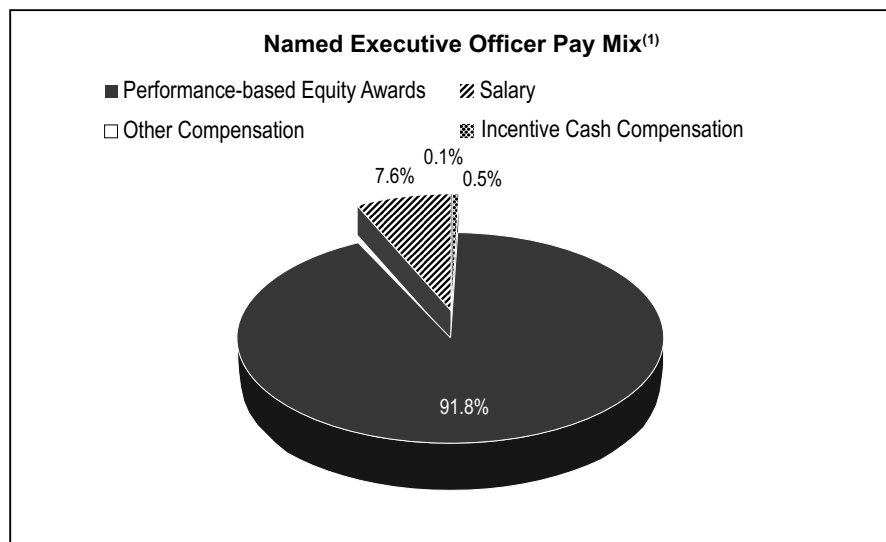

(1) The percentages above were calculated using base salary, incentive cash compensation, grant date fair value of equity awards (not cash actually received), and all other compensation as reported in the Summary Compensation Table.

In considering our pay structure for our CEO, CFO and other NEOs relative to our pay-for-performance policy, we also compared changes in compensation relative to total stockholder return, both at Cypress and our peer group companies. The data showed that since Cypress's stock price declined in fiscal year 2012, the realized total compensation of our NEOs has declined and no longer exceeds the median of our peer group companies. This reinforced our continued commitment to our pay-for-performance philosophy and our current pay structure.

In determining whether or not the above objectives are being met, the Company considers the results of the annual advisory 'say-on-pay' vote received by our stockholders. At our 2012 Annual Meeting, 80% of our stockholders approved the executive compensation programs used in 2011 and described in our 2012 Proxy Statement. We have employed the same compensation programs and policies for fiscal year 2012. After considering this strong stockholder support, the Committee has decided to continue to implement our effective pay-for-performance programs.

## Peer Group Companies

In determining the appropriate compensation, the Company collects and considers data from a group of peer companies. The Committee compares our executive compensation program, including base salary, total cash compensation and equity awards, with compensation paid by a peer group consisting of a broad range of high technology companies with which Cypress typically competes for executive talent. The Committee reviews the composition of the peer group on an annual basis. Our peer group companies for 2012 are listed in the table below:

Peer Group Companies in 2012	
Altera Corporation	Marvell Technology Group Limited
Atmel Corporation	Maxim Integrated Products, Inc.
Avago Technologies Limited	Microchip Technology Inc.
Cirrus Logic, Inc.	OmniVision Technologies, Inc.
Fairchild Semiconductor International, Inc.	ON Semiconductor Corporation
Integrated Device Technology Inc.	PMC-Sierra, Inc.
International Rectifier Corporation	Skyworks Solutions, Inc.
Intersil Corporation	Synaptics Incorporated
Linear Technology Corporation	Xilinx, Inc.
LSI Corporation	

Data gathered on the peer group companies by our independent compensation consultant includes base salary, bonuses, targeted cash compensation (as available), equity awards and total direct compensation. Deferred compensation plans and other benefits are generally not considered.

In assembling the fiscal year 2012 peer group, the Committee considered companies that met the following criteria: (1) companies that compete with Cypress for key leadership talent; (2) companies with global operations; (3) companies based in the U.S. with significant levels of resources dedicated to research and development; and (4) company size. Notably, Cypress is smaller in terms of revenue, total assets and market capitalization than some of its peer group companies, which is taken into account by the Committee when comparing total direct compensation between the peer group companies and Cypress. For 2012, we removed Analog Devices, Inc., Broadcom Corporation, National Semiconductor Corporation, NVIDIA Corporation and SanDisk Corporation from our peer group companies and added Cirrus Logic, Inc., Fairchild Semiconductor International, Inc., International Rectifier Corporation, Intersil Corporation, Maxim Integrated Products, Inc., OmniVision Technologies, Inc., Skyworks Solutions, Inc. and Synaptics Incorporated because each of these newly-added companies fit the criteria used for our peer group companies selection process. The Committee generally intends to continue using this peer group for fiscal year 2013. We will make changes to the peer group as needed to reflect mergers, split-ups, spin-offs, or other significant corporate transactions involving the peer group companies.

## Elements of Compensation

The components of our executive compensation program are: (i) base salary; (ii) variable and at-risk incentive cash compensation; (iii) performance-based equity awards; and (iv) limited benefit programs, such as our deferred compensation plans. We also offer standard health benefits and an employee stock purchase program to all our employees (excluding our CEO, who is ineligible to participate due to his greater than 5% stock ownership).

Below is a description of each of our elements of compensation, their objectives and their key features.

<b>Compensation Element</b>	<b>Objectives</b>	<b>Key Features</b>
Base Salary	<ul style="list-style-type: none"> <li>- To provide a fixed level of cash compensation to reward demonstrated experience, skills and competencies relative to the market value of the job.</li> </ul>	<ul style="list-style-type: none"> <li>- Targeted at the 50<sup>th</sup> percentile of our peer group companies, but varies based on skills, experience and other factors.</li> <li>- Adjustments are considered annually based on individual performance, level of pay relative to the market, and internal pay equity.</li> </ul>
Performance-Based Incentive Cash Compensation (KEBP, PBP & DBP)	<ul style="list-style-type: none"> <li>- Rewards annual corporate and individual performance and achieving strategic goals.</li> <li>- Aligns NEOs' interests with those of our stockholders by promoting strong annual results through increased profit margin, operating efficiency and achieving personal goals.</li> <li>- Retains NEOs by providing market-competitive compensation.</li> </ul>	<ul style="list-style-type: none"> <li>- Quarterly and annual cash incentive payments are based upon the achievement of financial targets (percentage of non-GAAP profit before taxes) and individual performance goals. These cash incentive payments are also subject to the CEO achieving a certain level of performance. Therefore, any cash payout under this program is 100% performance-based.</li> <li>- Annual cash incentive awards under KEBP and PBP can vary from 0% to 200% of the target amount.</li> <li>- Annual cash incentive awards under DBP can vary from -10% to 500% of the target amount.</li> </ul>
Performance-Based Restricted Stock (PARS)	<ul style="list-style-type: none"> <li>- Aligns NEOs' interests with long-term stockholder interests by linking part of each NEOs' compensation to long-term corporate performance.</li> <li>- Provides opportunities for wealth creation and ownership, which promotes retention and enables us to attract and motivate our NEOs.</li> <li>- Retention of NEOs through multi-year vesting of equity grants and annual performance periods.</li> </ul>	<ul style="list-style-type: none"> <li>- Targeted at a level that will provide total direct compensation (base + annual incentive + equity awards) approximating above the 75<sup>th</sup> percentile of our peer group's total direct compensation, but only if performance targets are achieved.</li> <li>- Since 2007, none of our NEOs participating in the PARS Program have received any additional standard awards.</li> </ul>
Non-Qualified Deferred Compensation	<ul style="list-style-type: none"> <li>- To provide retirement savings in a tax-efficient manner.</li> </ul>	<ul style="list-style-type: none"> <li>- NEOs can elect to defer up to 100% of their annual incentive cash payments or defer a portion of their base salaries.</li> <li>- Balances in the deferred compensation plan are unfunded obligations and at risk. Investment returns on balances are linked to the returns of mutual funds and do not generate any above market returns. The Company does not guarantee any return or provide any matching contributions.</li> </ul>

### *Base Salary*

Base salaries for our Named Executive Officers depend on the scope of their responsibilities, their leadership skills and values, their performance and length of service. Decisions regarding salary increases are affected by the NEOs current salary and the amounts paid to their peers within and outside the Company.

### *Performance-Based Incentive Cash Compensation*

We maintain three (3) performance-based incentive cash bonus plans. The Key Employee Bonus Plan (“KEBP”), in which all of our NEOs participate in except our CEO; the Performance Bonus Plan (“PBP”), in which our CEO is the only participant; and the Design Bonus Plan (“DBP”), in which Mr. Keswick, our Executive Vice President of New Product Development, is the only NEO participant as it is a bonus plan available only to our design and certain product development engineers.

Below is a summary of each of these incentive cash compensation plans. For actual fiscal year 2012 payments under each of these plans, please refer to “*Fiscal Year 2012 Executive Compensation Actions.*”

#### Key Employee Bonus Plan (“KEBP”)

Eligible senior and otherwise high-performing employees, including our Named Executive Officers, except our chief executive officer, participate in KEBP, which can pay out quarterly and annually and is a key part of our variable compensation structure. The objective of KEBP is to provide variable cash incentives to eligible participants. Each KEBP participant is placed at an incentive level, which determines the percentage of that individual’s base salary he or she is eligible to earn over the course of the year. Payout under KEBP is subject to achieving corporate financial performance objectives, individual performance objectives and CEO or executive officer performance. Therefore, payout can be drastically reduced or eliminated altogether depending on the performance of all three elements. The maximum target payout requires achieving very aggressive goals that are generally not fully achieved.

## 1. Corporate Performance

Payout under KEBP is subject to the Company attaining a certain financial performance milestone established by the Committee (the “Financial Milestone”). In 2012, the Committee established the Financial Milestone based on a percentage of the Company’s non-generally accepted accounting principles profit before taxes percentage (“non-GAAP PBT%”) (which excludes, but is not limited to, stock-based compensation, acquisition-related expenses, impairments to goodwill, gains or losses on divestitures, investment-related gains and losses, restructuring costs, minority interests and related tax effects and other one-time costs or benefits). The Financial Milestone for fiscal year 2012 was unchanged from the prior fiscal year. There is no payout if the non-GAAP PBT% is 15% or less. Once non-GAAP PBT% reaches 15%, the plan scales linearly to 100% of the bonus target upon achievement of 25% non-GAAP PBT%. The plan continues to scale linearly up to a cap of 200% once non-GAAP PBT% reaches 35% - a level that has never been attained in the Company’s history. The PBT Factor substantially reduced KEBP payouts to our NEOs in fiscal year 2012. Below is a chart illustrating the floor, target and maximum payout thresholds:

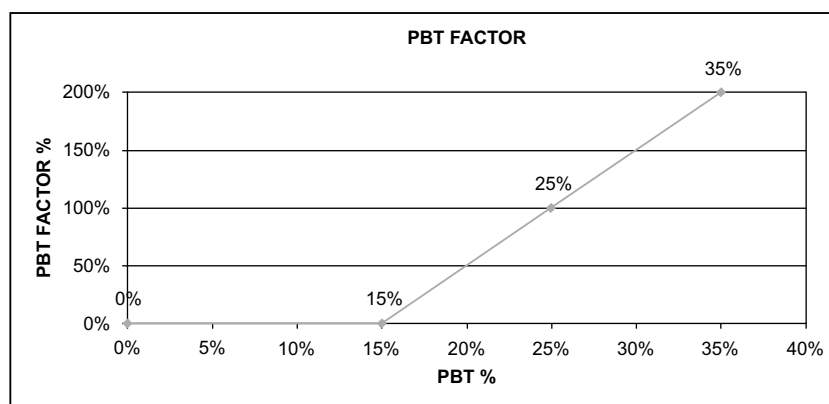

## 2. Individual Performance

The second element to KEBP is the achievement of individual performance objectives. These individual performance objectives, also known as “CSFs,” are measurable quarterly and annual performance goals that are identified by our executive officers or CEO and reviewed, modified as appropriate, and approved by our CEO in advance of each review period. Our CEO’s CSFs are submitted to, reviewed, modified as appropriate, and approved by the Board. Following each quarter, the CEO’s score is then reviewed, adjusted if necessary, and approved by the Committee.

CSFs for each period are scored on a scale of 0 to 100%, with each CSF representing a specific point value based on its importance to the Company and/or its level of difficulty. Specific scoring parameters that are used to determine whether the CSF has been achieved are also identified in advance in writing. At the end of each fiscal quarter, or fiscal year, as applicable, our executive officers “score” their CSFs based on the scoring parameters previously established. This score is reviewed, adjusted if necessary, and approved by our CEO. The specific CSFs designated for each executive officer often vary from quarter to quarter, and may include Company metrics, divisional metrics and individual performance metrics. Historically, our NEOs do not achieve 100% of their CSFs. In fiscal year 2012, our NEOs scored between 63% and 88% on their CSFs and in fiscal year 2011, they scored between 33% and 108% on their CSFs.

### 3. Executive Officer Performance

The third element under KEBP is executive officer performance (the “EO Factor”). The EO Factor, regardless of the individual’s CSF achievement, can only reduce each NEOs KEBP payment. The EO Factor is determined by using the lower of the CEO CSF score or the NEO CSF score to determine an EO Factor. The EO Factor is determined as follows:

<b>If the LOWER of the CEO CSF score and/or NEO CSF score is:</b>	<b>Then the EO Factor is:</b>
80.0 or higher	100%
65.0 or higher, and less than 80.0	50%
Less than 65.0	0%

The EO Factor has typically reduced KEBP payouts to NEOs at least once per year over the last few years, including most recently in the third quarter of fiscal year 2012. The EO Factor further demonstrates the link between pay and performance under the Company’s incentive cash compensation plans.

### 4. Payout under KEBP

To be eligible for a KEBP payment, the KEBP participant must still be employed by the Company on the payment date. There are 5 payouts under KEBP. Quarterly payouts under KEBP are made in the quarter following the measuring period, and the payout for the annual target is made within the first quarter following the applicable year.

Payouts under KEBP may be higher or lower based on the Company’s results and an individual’s CSF score, such that each NEO is motivated and challenged to achieve both short and long-term goals for the Company. The principles of a payout under KEBP are embedded in the following formula established by the Committee, which reflects how each incentive cash bonus payment is determined:

$$\text{Annual Base Pay} \times \frac{\text{Incentive Target Level\%}}{5} \times \frac{\text{Financial Performance Metric \% Achievement}}{\text{CSF Score}} \times \text{EO Factor}$$

### Performance Bonus Plan (“PBP”)

Our CEO was the only participant under the PBP in fiscal year 2012, and is currently the only participant. A PBP participant is not eligible to participate in KEBP. The PBP was designed to maintain the corporate tax deduction under Internal Revenue Code Section 162(m) for certain variable cash compensation paid to an executive officer to the extent such compensation exceeds \$1 million in any one year.

Under the PBP, participants are eligible to receive cash payments based upon the attainment and certification of certain objective performance criteria established by the Committee. The performance measures for any performance period are one or more objective performance criteria, applied to either the Company as a whole or, except with respect to stockholder return metrics, to a region, business unit, product line, affiliate or business segment, and measured either on an absolute basis or relative to a pre-established target, to a previous period’s results or to a designated comparison group, in each case as specified by the Committee. Financial metrics may be determined in accordance with U.S. generally accepted accounting principles (“GAAP”), in accordance with International Accounting Standards Board (“IASB”) principles or may exclude any items otherwise includable under GAAP or IASB principles.

The PBP operates exactly like KEBP. It contains a corporate performance metric and individual performance metrics. Similar to KEBP, in fiscal year 2012 the Committee established non-GAAP PBT% as the PBP quarterly and annual corporate performance metric and it is calculated using the same formula described above. In addition, our CEO has individual performance objectives, or CSF’s, on a quarterly and annual basis. Our CEO’s

CSFs are submitted to, reviewed, modified as appropriate, and approved by the Board. Following each quarter, the CEO's score is then reviewed, adjusted if necessary, and approved by the Committee. Like KEBP, even where the Company's goal has been achieved, the actual payout is subject to reduction based on the CEO's CSF score for the period. If the CEO's CSF score for the period is more than 65.0% but less than 80.0%, then the CEO's PBP payment is reduced by 50% for that period. If the CEO's CSF score for the period is less than 65.0%, then the CEO's PBP payment is reduced to zero for that period.

The PBP, like KEBP, has quarterly and annual components. Our Committee retains the discretion to reduce or eliminate any PBP award that would otherwise be payable.

#### Design Bonus Plan ("DBP")

The Design Bonus Plan was instituted in 2010 to incentivize design and engineering efforts at the Company. The DBP is available to all employees who are design engineers and certain product development engineers. Mr. Keswick was the only NEO who participated in the DBP in fiscal year 2012. Participants in the DBP are eligible to receive an incentive multiplier ("IM") of 2X their cash incentive compensation for on-time performance and up to 5X for delivering First 100 Engineering Samples ("ES100"), a significant product development milestone, ahead of schedule. To participate in the DBP, eligible NEO's must put at-risk 10% of their quarterly base salary and 50% of what would be earned under the quarterly KEBP. Actual payout under the DBP is measured by evaluating progress of the project made relative to the original schedule from the first day of the quarter to the last day of the quarter. The IM is calculated based on the achievement of project milestones ahead or behind the original project schedule for any given fiscal quarter. If the IM does not reach a certain level of achievement, then a component of the quarterly bonus payment will be further subject to a vesting period. The funds will vest upon reaching certain achievement levels and are subject to scaling factors based on the difference between the original commitment and actual performance.

Payouts under the DBP are calculated as follows:

Pay Out (current period) = (50% of KEBP earned + 10% of quarterly base salary) \* Incentive Multiplier (up to 1.5 on each project)

Bonus payments for an IM greater than 1.5 are payable once the ES100 milestone is achieved, and are subject to an ES100 scaling factor, which can range from 0% to 150%. The formula for these additional payments is as follows:

Pay Out (future vesting, paid at ES100) =  
(50% of KEBP + 10% of quarterly base salary) \* Incentive Multiplier (above 1.5 on each project) \*  
ES100 Scaling Factor

#### *Performance Accelerated Restricted Stock Program ("PARS")*

Our equity program is intended to provide a long-term incentive to help (1) achieve our business objectives, (2) attract, motivate and retain key talent, and (3) align our executives' interests with stockholders' interests. Our Amended and Restated 1994 Stock Plan (the "Plan") permits us to grant service-based awards and long-term performance-based awards, including our PARS program that we adopted in 2007 to retain and incentivize key employees.

In 2007, under the PARS program, we awarded five-year performance-based vesting restricted stock units ("RSUs") to key employees, including our NEOs and our other executive officers. Our executive officers, including our NEOs, did not receive any other standard awards since their PARS grant in 2007, which were earned from 2007-2011. With the original PARS grant due to expire in 2011, we took steps to ensure the effectiveness of the PARS program going forward. To that end, in February 2012, we awarded one-year performance-based vesting RSUs to our executive officers that covered 2012. The Committee releases all earned shares following certification that the applicable performance milestone has been achieved, net of all federal and state withholding tax requirements. Following final certification by the Committee, if the



performance milestone is not achieved in full, the portion of the target shares for that particular performance milestone in the given period is forfeited and returned to the Plan.

For achievement in fiscal year 2012 of the 2012 PARS award, please refer to “2012 Performance Accelerated Restrict Stock Program (“PARS”).”

#### *Non-Qualified Deferred Compensation*

The Company also maintains an unfunded, nonqualified deferred compensation plan which allows eligible participants, including executive officers, to voluntarily defer receipt of a portion or all of their salary or cash bonus payment, as the case may be, until the date or dates elected by the participants, thereby allowing the participating employees to defer taxation on such amounts. There are two Non-Qualified Deferred Compensation plans available, one of which pays a death benefit two times participant contributions. All eligible employees have the option to choose which plan they participate. Mr. Rodgers and Mr. Seams qualify for the death benefit payable under their Non-Qualified Deferred Compensation plan. Refer to the table entitled “*Non-Qualified Deferred Compensation*” for employee contributions and performance under this benefit plan in fiscal year 2012.

#### *Other Compensation Limited*

We limit all other compensation to our Named Executive Officers. For example, the Company does not provide a defined benefit pension plan, a match to employee contributions to our 401(k) plan or any material perquisites.

#### *No Employment and Severance Agreements*

Our Named Executive Officers do not have employment, severance or change-of-control agreements. They serve at the will of the Board, which enables us to set the terms of any termination of employment.

## **2012 Overview**

### *Financial Performance*

The Company grew revenue a very strong 31% annually in 2010 and 13% in 2011, at a rate far greater than the industry. However, the macro issues impacting the world plus some customer specific issues impacted us far greater than the average company in our industry for fiscal year 2012. As such our financial performance suffered and earned compensation was down to the lowest levels since 2005. Some of our fiscal year 2012 financial and operational results are as follows:

- Our revenue decreased 22.7% in fiscal year 2012 due to certain end customer issues and a weak macro environment.
- GAAP earnings per share decreased from \$0.90 in fiscal year 2011 to a loss of \$0.15 per share in fiscal year 2012 due to lower earnings, one-time items that were benefits in fiscal year 2011 that did not re-occur in fiscal year 2012 and one-time acquisition related expenses associated with our acquisition of FRAM memory maker, Ramtron International Corporation.
- Non-GAAP earnings per share decreased from \$1.25 in fiscal year 2011 to \$0.55 in fiscal year 2012 due mainly to lower earnings.
- Cash flow from operations totaled \$135 million or 17.5% of revenue.
- We achieved a fiscal year 2012 non-GAAP return on assets of 52%.
- We returned \$295 million in cash to our stockholders through our stock repurchase and dividend programs.

- We increased our quarterly dividend from \$0.09 per share to \$0.11 per share, a current yield of approximately 4% which is a rate almost 200% greater than the S&P.
- We achieved significant major new product launches in SRAM, USB, PSoC and TrueTouch
- We further enhanced our product portfolio by acquiring Ramtron and divesting Cypress Envirosystems, Inc.
- Our three-year average equity net burn rate (which reflects the potential dilutive effect of our annual stock grants is calculated by expressing the total net equity awards in a given year as a percentage of the total number of common shares outstanding) of 1.9% continues to be well below industry standards.
- Stock-based compensation expense decreased 26% in fiscal year 2012 to the lowest level since 2006.

For six straight years ending in fiscal year 2011, our annual stock price performance outperformed the Philadelphia Semiconductor Sector Index (“SOXX”) our major semiconductor benchmark index. That strong streak ended in fiscal year 2012 and we substantially under-performed the SOXX. Our stock price for fiscal year 2012 was very volatile and ranged from a high of \$19.15 to a low of \$8.89 and closed fiscal year 2012 at \$10.50. Since our \$2.6 billion spin-off of SunPower Corporation to our stockholders in September 2008 and through our 2012 fiscal year-end, our common stock has appreciated by 101% exceeding the SOXX by a wide margin, which increased 23%. On a five-year basis, which is our major long-term benchmark, we exceeded the SOXX by 88%. Please refer to the tables below for a comparison of our stock price performance to our major benchmarks.

**One-Year Stock Performance: Fiscal Year End 2011 vs. Fiscal Year End 2012**

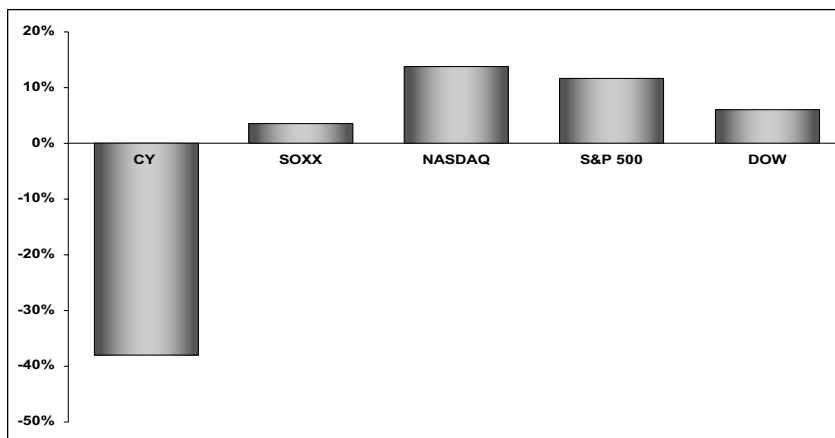

**Post SunPower Spin-Off Appreciation: September 30, 2008 to Fiscal Year End 2012**

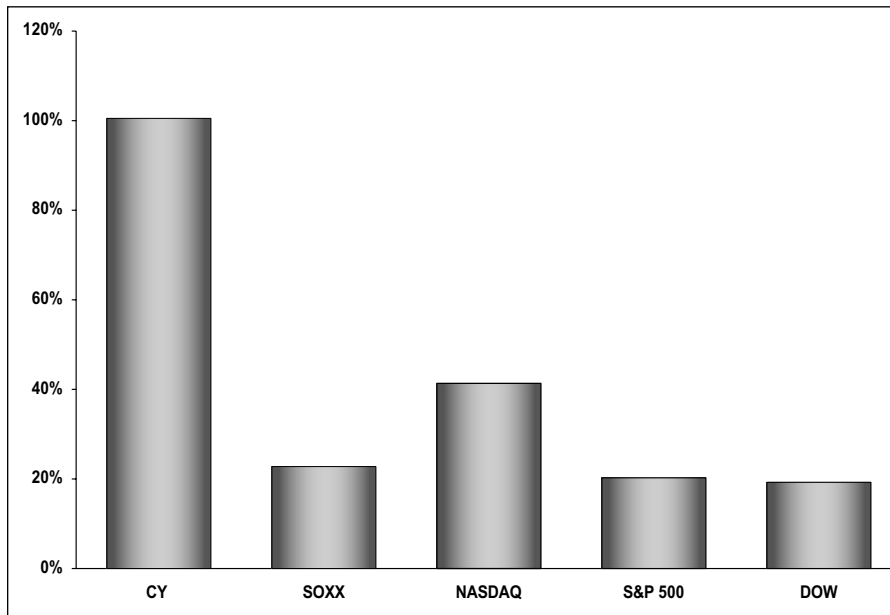

**Five-Year Stock Appreciation: Fiscal Year End 2007 vs. Fiscal Year End 2012**

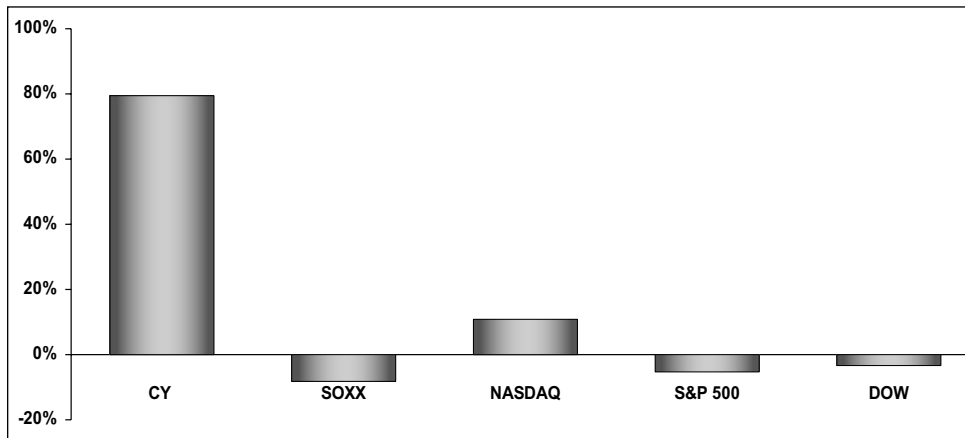

*Fiscal Year 2012 Executive Compensation Actions*

During fiscal year 2012 the Company made no major changes to its pay-for-performance compensation philosophy or to the main financial targets of its compensation elements. As a result of our mixed financial performance, executive compensation decreased significantly, consistent with our pay-for-performance compensation programs.

### 2012 Base Salary

We target executive officers' base salaries at approximately the 50<sup>th</sup> percentile of base salaries for similar positions in our peer group companies. In May 2012, as part of its annual review of executive compensation, the Committee reviewed the base salaries of our Named Executive Officers, focusing on the competitiveness of salaries and ensuring base salaries remained at or near the 50<sup>th</sup> percentile. Based on that review, our Named Executive Officers, including our CEO, did not receive salary increases. Instead, their base salaries were maintained to the approximate median level among our peer group companies. Below is a summary of the salary of our NEOs for fiscal year 2012:

Name	2012 Salary	% Increase from 2011
T.J. Rodgers	\$600,000	0%
Brad W. Buss	\$347,527	0%
Paul D. Keswick	\$329,073	0%
Christopher A. Seams	\$394,714	0%
Dana C. Nazarian	\$279,965	0%

### 2012 Incentive Cash Compensation

Consistent with our pay-for-performance philosophy, the lack of performance in various financial and operational goals in fiscal year 2012 resulted in substantially lower incentive cash compensation to our NEOs in 2012 versus fiscal year 2011.

#### Key Employee Bonus Plan

In 2012, the incentive cash compensation target percentage for our executive officers remained the same as in previous years and was targeted to provide an above-median opportunity of 80% of base salary for all of Named Executive Officers, except our CEO, under our KEBP program. No executive officer achieved the targeted total cash compensation for each performance period either in 2011 or 2012.

The quarterly and annual targets for non-GAAP PBT%, our actual non-GAAP PBT% achievement, and the percentage of achievement against plan for our 2012 fiscal year are set forth in the following table (percentage achievement is calculated on a linear scale where 15% is zero and 25% is at 100%):

2012 Fiscal Year Period	Non-GAAP PBT% Target	Non-GAAP PBT% Achieved	Percentage Achievement Against Target
First Quarter	25.0%	11.3%	0%
Second Quarter	25.0%	15.3%	3.5%
Third Quarter	25.0%	16.7%	17.2%
Fourth Quarter	25.0%	4.4%	0%
Annual	25.0%	12.2%	0%

In determining the amount of cash incentive pay payable under KEBP, the Committee uses the final CSF scores for the given review period as a component in the formulas that determine the bonus to be paid under each plan. In order to apply its discretion to reduce the maximum payout under KEBP, the Committee considers the participant's CSF score for the applicable period. Below is a summary of certain quarterly and annual CSF performance goals for each Named Executive Officer:

Brad W. Buss. In fiscal year 2012, our chief financial officer, Mr. Brad W. Buss' annual and quarterly CSFs included implementing initiatives with distributors, establishing a revolving line of credit, executing strategies

for improved stockholder returns, revenue and profit improvement, and executing on our world class profit initiative. Mr. Buss also had goals related to achieving certain cost savings, executing patent monetization strategies, improving certain business processes, the acquisition and integration of Ramtron International Corporation and implementing programs to make it easier for customers to do business with Cypress.

Paul Keswick. In fiscal year 2012, our executive vice president of New Product Development, Mr. Paul Keswick's annual and quarterly CSFs included developing and executing various plans for 2012 product launches, new product development, and improving several of Cypress's business and product design processes. Mr. Keswick also had goals related to developing and executing design and applications, reducing operating expenses, integrating worldwide design sites, executing information technology projects, ensuring team development and increasing customer satisfaction.

Christopher Seams. In fiscal year 2012, our executive vice president of Sales and Marketing, Mr. Christopher Seams' annual and quarterly CSFs included team and site development, maintaining ASPs, increasing profit, market penetration and new design wins, and increasing customer satisfaction, including developing stronger relationships with key customers. Mr. Seams also had goals related to product launches, achieving certain revenue performance targets, developing and measuring programs to improve our customer base for specific product lines, reducing sales and marketing expenses, and other strategic initiatives for product marketing and distribution.

Dana Nazarian. In fiscal year 2012, our executive vice president of the Memory Products Division, Mr. Dana Nazarian's 2012 annual and quarterly CSFs included reducing manufacturing expenses, increasing SRAM market share, improving gross margin and achieving other key financial metrics. Mr. Nazarian also had goals related to managing inventory levels, the acquisition and integration of Ramtron International Corporation, new product development and launches, and developing stronger relationships with key customers.

Below is a historical table that shows the two-year KEBP achievement by our Named Executive Officers:

KEBP	2011						2012					
	Q1	Q2	Q3	Q4	ANNUAL	AVERAGE	Q1	Q2	Q3	Q4	ANNUAL	AVERAGE
Brad W. Buss	59%	89%	108%	38%	84%	76%	0%	2%	7%	0%	0%	2%
Paul D. Keswick	58%	79%	44%	35%	35%	47%	0%	1%	7%	0%	0%	2%
Christopher A. Seams	57%	82%	108%	34%	78%	72%	0%	1%	6%	0%	0%	1%
Dana C. Nazarian	—	—	—	—	—	—	0%	1%	6%	0%	0%	1%

#### Performance Bonus Plan

In fiscal year 2012, the incentive cash compensation target percentage for our CEO remained the same as in previous years and was targeted to provide an above-median opportunity of 175% of base salary under the PBP.

The Non-GAAP PBT% under the PBP was the same payout as described above under "Key Employee Bonus Plan."

In fiscal year 2012, our chief executive officer, Mr. T.J. Rodgers' annual and quarterly CSF performance goals included strategies for reducing operating expense, increasing revenue, improving gross margin and achieving other financial metrics, achieving certain design win metrics, maintaining ASPs, new product development and launches, and measuring programs to make it easier for customers to do business with Cypress. Mr. Rodgers' goals also included new system and software development, achieving certain quality milestones, team and site development, and strategic hiring.

Below is a historical table that shows the two-year PBP achievement by our CEO:

PBP	2011						2012					
	Q1	Q2	Q3	Q4	ANNUAL	AVERAGE	Q1	Q2	Q3	Q4	ANNUAL	AVERAGE
T.J. Rodgers	61%	87%	101%	33%	79%	72%	0%	1%	6%	0%	0%	1%

### Design Bonus Plan

In fiscal year 2012, Mr. Paul Keswick, our executive vice president of New Product Development, is the only NEO who participated in the DBP. Mr. Keswick's IM is calculated for each period based on a weighted average of the performance of active new product projects compared to their original schedules.

Below is a historical table that shows Mr. Keswick's IM achievement under DBP over the last eight quarters:

		2011					2012				
<b>DBP Incentive Multiplier</b>		<b>Q1</b>	<b>Q2</b>	<b>Q3</b>	<b>Q4</b>	<b>AVERAGE</b>	<b>Q1</b>	<b>Q2</b>	<b>Q3</b>	<b>Q4</b>	<b>AVERAGE</b>
Paul D. Keswick	Paid in Current Period	1.13	1.16	0.91	0.76	0.99	1.40	1.05	.90	.98	1.08
	Vested for Possible Future Payout	1.63	1.39	0.50	0.88	1.10	1.21	.88	1.06	.89	1.01
	Total	2.76	2.55	1.41	1.64	2.09	2.61	1.93	1.96	1.87	2.09

### *2012 Performance Accelerated Restrict Stock Program ("PARS")*

In early 2012, the Committee set the performance goals under which participants were eligible to earn their PARS. There are 3 levels of grants under the 2012 PARS program: the Core Grant, Tier 1 Grant and Tier 2 Grant. The milestones for each grant and the actual percent achieved in fiscal 2012 were as follows:

#### **Core Grant**

57.14% of the total targeted PARS award could be earned based on the Core Grant Scorecard, which is based on the CEOs fiscal year 2012 CSFs (which included financial, product development and business process improvement goals). The payout for this milestone is 100% if the "Core Grant Scorecard" achieves a score of 90.0 points or greater and adjusts on a linear scale down to 0% if 50.0 points or less is achieved. For fiscal year 2012, the Core Grant Scorecard was 70.39 out of 100 and the percentage attainment was 51%.

#### **Tier 1 Grant**

28.57% of the total targeted PARS award could be earned if Cypress is awarded one or more design wins opportunities at a leading consumer product company in fiscal year 2012 using a TrueTouch or Trackpad product. The payout for this milestone is 100% if the total design win opportunity is at least \$5.0 million and adjusts on a linear scale down to 0% if the total design win opportunity value is \$2.5 million or less. For fiscal year 2012, the Tier 1 Grant milestone achievement was zero.

#### **Tier 2 Grant**

14.29% of the total targeted PARS award could be earned if Cypress's revenue increases at a higher annual rate during fiscal year 2012 than Altera Corporation, Atmel Corporation, GSI Integrated Device Technology, Inc., Maxim, Microchip Technology Inc., SMSC, Synaptics, Inc. or Xilinx, Inc. ("Tier 2 Grant Peer Group"). For fiscal year 2012, the Tier 2 Grant milestone achievement was zero. The payout for this milestone adjusts as follows:

Payout	Requirement
100%	Cypress must achieve the highest annual growth rate versus the Tier 2 Grant Peer Group
75%	Cypress must achieve the second highest annual growth rate versus the Tier 2 Grant Peer Group
50%	Cypress must achieve the third highest annual growth rate versus the Tier 2 Grant Peer Group
25%	Cypress must achieve the fourth highest annual growth rate versus the Tier 2 Grant Peer Group
0%	Cypress's annual grown rate is lower than the fourth highest among the Tier 2 Grant Peer Group

The following table sets forth the maximum targeted shares that could be earned in fiscal year 2012 by our Named Executive Officers under PARS and the actual payouts, as approved by the Compensation Committee for our Named Executive Officers. The maximum number of targeted shares that could be earned in fiscal year 2012 versus fiscal year 2011 was reduced by 12.5% for each Named Executive Officer. The total overall achievement under the PARS program in fiscal year 2012 was approximately 29% of target, the lowest percentage achieved under the PARS program since its inception in 2007. Due to not achieving 100% of the targeted shares, 1,250,420 shares previously granted to our NEOs were forfeited and returned to the Company's equity pool in January 2013.

Named Executive Officer	2012 Maximum Target Shares	Total Number of Shares Earned in 2012
T.J. Rodgers	576,831	168,022
Brad W. Buss	360,519	105,013
Paul D. Keswick	288,416	84,011
Christopher A. Seams	288,416	84,011
Dana C. Nazarian	250,164	72,869

The actual dollar value earned by the NEO's was 80% lower than fiscal year 2011. The dollar amount shown in the Summary Compensation Table for PARS grants reflects the ASC 718 fair value on the date the shares were granted and assumed a 90% attainment of the Core Grant and zero percent attainment of each of the Tier 1 and Tier 2 Grants, which were stretch goals, in accordance with SEC Regulation S-K, Item 402. In 2012, our stock price on the date of grant was \$15.94 and the price on December 31, 2012, the date of delivery, was \$10.50. The following table shows what was actually earned by showing the difference between the grant date fair value and the delivery date value. As a result of our lower trading price at the end of fiscal year 2012 and our failure to fully achieve our Core Grant Target, the delivery date value was approximately 38% lower than the grant date value. Delivery date values are pre-tax amounts and after tax amounts are approximately 45% to 60% lower depending on each NEO's personal tax rate.

Named Executive Officer	Grant Date Value (\$)	Delivery Date Value(\$)
T.J. Rodgers	4,728,684	1,764,231
Brad W. Buss	2,955,418	1,102,637
Paul D. Keswick	2,364,350	882,116
Christopher A. Seams	2,364,350	882,116
Dana C. Nazarian	2,050,775	765,125

#### *CEO Compensation*

Consistent with the Company's philosophy on pay-for-performance, in fiscal year 2012, over 92.5% of Mr. Rodgers' total direct compensation was in the form of variable compensation, comprised of performance-based quarterly and annual incentive cash bonuses and annual performance-based restricted stock units. Mr. Rodgers did not receive an increase in his base salary in fiscal year 2012 and has not received any increase since fiscal year 2006. Mr. Rodgers received a maximum targeted PARS grant in fiscal year 2012 with a grant date fair value 20% lower than fiscal year 2011. In fiscal year 2012, Mr. Rodgers received an average achievement of 1% under his incentive cash bonus plan and 29.13% achievement under the performance-based restricted stock unit program, levels significantly lower than in fiscal year 2011.

## **Fiscal Year 2013 Executive Compensation Actions**

### *Key Employee Bonus Plan and Performance Bonus Plan*

In fiscal year 2013, the Financial Milestone for our NEOs participating in KEBP and PBP was set at 10% PBT for the zero percent point and 20% for the 100% point. There is no payout if the non-GAAP PBT% is 10% or less. Once non-GAAP PBT% reaches 10%, the plan scales linearly to 100% of the bonus target upon achievement of 20% non-GAAP PBT%. The plan continues to scale linearly up to a cap of 200% once non-GAAP PBT% reaches 30%. It is currently expected that the actual achievement will be significantly under the target threshold.

### *Executive Compensation*

Executive management proposed that they receive no base salary increase in 2013, unless due to changes in roles and responsibilities, and the Compensation Committee has agreed.

## **Other Compensation-Related Policies**

### *The Role of the Compensation Committee*

The Committee:

- establishes the performance objectives for our chief executive officer and other Named Executive Officers and evaluates and adjusts their compensation based on achievement of those objectives.
- formulates, approves, reviews and modifies the compensation of the Company's directors and executive officers.
- oversees the administration of the Company's compensation plans.
- recommends to the Board for approval the Company's compensation plans, policies and programs.
- reviews, revises in its discretion, and approves the annual merit and stock budgets for focal salary increases and equity grant awards for all eligible employees.
- reviews and revises in its discretion the annual benefit changes made by the Company with respect to its employees.
- oversees equity plans of the Company's subsidiaries.
- oversees annual risk analysis of our compensation policies and programs, including the clawback policy.

### *The Role of Compensation Consultants*

Buck Consultants, LLC, an independent compensation consulting firm is engaged as a consultant by the Committee, reports directly to the Committee, and assists the Committee in determining the appropriate executive compensation for our Named Executive Officers. This is done, in part, by comparing the current salary, bonus, and equity awards of our Named Executive Officers to comparable positions at peer group companies. Buck Consultants is independent from the Company, has not provided any services to the Company other than to the Committee, and receives compensation from the Company only for services provided to the Committee. The Committee typically asks Buck Consultants to attend the Committee's regular meetings and many of the Committee's special meetings, including executive sessions of the Committee at which management is not present.

### *The Role of Executive Officers in Determining Executive Compensation*

Other than our chief executive officer, who participates in setting the compensation of the other executive officers through his recommendations to the Committee, our executive officers do not directly participate in



determining their compensation. Our chief executive officer does not participate directly in setting his own compensation. However, our executive officers, including our chief executive officer, do participate indirectly by initially proposing their quarterly and annual goals (subject to review, revision and approval), the achievement of which impacts their variable cash compensation under our cash incentive plans. Mr. Rodgers' salary, bonus and equity grants are determined by the Committee after considering the peer group analysis undertaken by our consultant, Mr. Rodgers' job performance, the responsibilities of his position, and Company performance.

#### *Prohibition on Derivative Trading*

We prohibit derivative transactions in our Company stock by officers and directors directly or indirectly. Specifically, a director or an officer may not, at any time:

- directly or indirectly sell any equity security, including derivatives, of the Company if he or she (1) does not own the security sold, or (2) if he or she owns the security, does not deliver it against such sale (a "short sale against the box") within twenty days thereafter, or does not within five days after such sale deposit it in the mail or other usual channels of transportation.
- engage in short sales, the purchase of put options or any other transaction whereby one derives a benefit from a decline in the Company's stock price.

#### *Use of Cypress Owned Shares in Margin or Collateral Accounts*

Our NEO's and other executive officers and directors may from time to time use the Cypress shares they own outright as collateral for margin or other type of loan instruments. Under such agreements, the shares may be called away and sold by third parties in certain circumstances. This could impact the NEO's share ownership, impact the share price of the Company's common stock, or take place when the trading window is otherwise closed for our NEOs. Currently Messrs. Rodgers and Buss use a substantial portion of their Cypress shareholdings as collateral under various margin and debt instruments. The stock price of the Company continues to be volatile and as such those shares could potentially get called away or sold to satisfy a potential margin call. Even if such shares were called, Messrs. Rodgers and Buss would still meet their minimum stock ownership requirements.

#### *Perquisites and Other Benefits*

Cypress does not provide any material perquisites to its Named Executive Officers.

#### *Company's policy on IRS 162(m)*

Our management and the Committee have considered the implications of Section 162(m) of the Internal Revenue Code of 1986. This section precludes a public corporation from taking a tax deduction for individual compensation in excess of \$1 million for its chief executive officer or certain other executive officers. This section also provides for certain exceptions to this limitation, including compensation that is performance-based within the meaning of Section 162(m). Our Performance Bonus Plan enables us to qualify more compensation as deductible performance-based compensation. Many of our executive compensation plans are designed to qualify payments thereunder as deductible performance-based compensation. In order, however, to preserve flexibility in designing our compensation programs, not all amounts we pay may qualify for deductibility.

#### *Severance/Change-in-Control Compensation*

None of our Named Executive Officers have contractual severance or change-in-control benefits.

## **REPORT OF THE COMPENSATION COMMITTEE OF THE BOARD OF DIRECTORS**

*The information in this report shall not be deemed to be “soliciting material” or “filed” with the Securities and Exchange Commission or subject to the liabilities of Section 18 of the Securities Exchange Act of 1934, as amended (the “Exchange Act”), except to the extent that Cypress specifically incorporates it by reference into a document filed under the Securities Act of 1933, as amended or the Exchange Act.*

We have reviewed and discussed the foregoing Compensation Discussion and Analysis (which is incorporated by reference in this report) with management. Based on our review and discussion with management, we have recommended to the Board of Directors that the Compensation Discussion and Analysis be included in this Proxy Statement and in Cypress’s Annual Report on Form 10-K for the year ended December 30, 2012.

### **COMPENSATION COMMITTEE OF THE BOARD OF DIRECTORS**

Eric A. Benhamou, Chairman  
Lloyd Carney  
James R. Long

## EXECUTIVE COMPENSATION

### Summary Compensation Table

The following table shows compensation information for fiscal years 2010, 2011 and 2012 for the Named Executive Officers.

Name and Principal Position	Year	Salary <sup>1</sup> (\$)	Bonus <sup>2</sup> (\$)	Stock Awards <sup>3</sup> (\$)	Option Awards (\$)	Non-Equity Incentive Plan Compensation <sup>4</sup> (\$)	All Other Compensation <sup>5</sup> (\$)	Total Compensation (\$)
T.J. Rodgers President, Chief Executive Officer and Director	2012	726,919	—	4,728,684	—	15,865	4,356	5,475,824
	2011	669,227	—	11,460,141	—	757,087	4,356	12,890,811
	2010	598,766	—	7,239,062	—	1,092,807	266,805 <sup>6</sup>	9,197,440
Brad W. Buss Executive Vice President, Finance & Administration, Chief Financial Officer	2012	347,526	6,683	2,955,418	—	3,944	536	3,314,107
	2011	343,630	—	7,162,590	—	208,561	526	7,715,307
	2010	333,631	—	4,524,414	—	291,212	512	5,149,769
Paul D. Keswick Executive Vice President, New Product Development	2012	329,077	—	2,364,350	—	62,354	1,440	2,757,221
	2011	325,629	—	5,730,062	—	158,711	756	6,215,158
	2010	319,527	—	3,619,531	—	276,770	745	4,216,573
Christopher A. Seams Executive Vice President, Sales and Marketing	2012	394,722	—	2,364,350	—	4,506	951	2,764,529
	2011	407,356	—	5,730,062	—	225,293	604	6,363,315
	2010	373,461	—	3,619,531	—	322,392	583	4,315,937
Dana C. Nazarian Executive Vice President, Memory Products Division	2012	290,736	—	2,050,775	—	3,394	414	2,345,319
	2011	—	—	—	—	—	—	—
	2010	—	—	—	—	—	—	—

1. Represents actual salary earned in fiscal years 2012, 2011 and 2010. Salary. The 2011 salary reflects paid-time-off cash out by Mr. Rodgers of \$69,230. The 2012 salary reflects paid-time-off cash out by Mr. Rodgers of \$126,922 and paid-time-off cash out by Mr. Nazarian of \$10,768. Mr. Rodgers deferred his entire salary for fiscal year 2012 into his nonqualified deferred compensation plan.
2. Represents 40 hours of pay received for seven years of service. All regular employees who work at least 20 hours per week are eligible for the seven year service award.
3. Amounts shown do not reflect compensation actually received by the Named Executive Officer. Instead, the amounts reported above in the “Stock Awards” column represents the aggregate grant date fair value of stock awards and option awards granted in the respective fiscal years assuming the probable level of performance achieved as of the grant date, as determined pursuant to ASC 718. For fiscal year 2012, it was assumed that 90% of the Core Grant would be achieved and zero percent of each of the Tier 1 and Tier 2 Grants, which were stretch goals, would be achieved. For fiscal years 2010 and 2011, 100% achievement was assumed. The assumptions used to calculate the value of stock awards are set forth in Note 8 of the Notes to Consolidated Financial Statements included in our Annual Report on Form 10-K for fiscal year 2012 filed with the SEC on February 28, 2013. In fiscal year 2012, the following shares of restricted stock units were earned by the Named Executive Officers: Mr. Rodgers, 168,022 shares; Mr. Buss, 105,013 shares; each of Messrs. Keswick and Seams, 84,011 shares; and Mr. Nazarian, 72,869 shares.
4. Includes bonus amounts earned under our KEBP, PBP and DBP for services rendered in the respective fiscal years.

5. The amounts reported in this column include payments by the Company of term life insurance premiums for the Named Executive Officers. The Company is not the beneficiary of the life insurance policies. Named Executive Officers participate in the same life insurance program as all other Cypress employees, which pay out at one times the employee's annual base pay.
6. \$262,449 reflects government fees and related expenses paid in connection with a Hart-Scott-Rodino (HSR) filing that was required on behalf of Mr. Rodgers due to his substantial ownership of Cypress common stock.

## GRANTS OF PLAN-BASED AWARDS

Fiscal Year Ended December 30, 2012

The following table shows all plan-based awards granted to the Named Executive Officers during fiscal year 2012.

Name and Principal Position	Grant Date	Estimated Possible Payouts Under Non-Equity Incentive Plan Awards <sup>1</sup>			Estimated Future Payouts Under Equity Incentive Plan Awards <sup>2</sup>			All Other Stock Awards: Number of Shares of Stock or Units (#)	All Other Option Awards: Number of Securities Underlying Options (#)	Exercise or Base Price of Option Awards (\$/SH)	Grant Date Fair Value of Stock and Option Awards (\$)
		Threshold (\$)	Target (\$)	Maximum (\$)	Threshold (#)	Target (#)	Maximum (#)				
T.J. Rodgers President, Chief Executive Officer and Director	Q1	0	210,000	420,000	—	—	—	—	—	—	—
	Q2	0	210,000	420,000	—	—	—	—	—	—	—
	Q3	0	210,000	420,000	—	—	—	—	—	—	—
	Q4	0	210,000	420,000	—	—	—	—	—	—	—
	Annual	—	210,000	420,000	0	576,831	576,831	—	—	—	—
Brad W. Buss Executive Vice President, Finance and Administration, Chief Financial Officer	Q1	0	55,604	111,208	—	—	—	—	—	—	—
	Q2	0	55,604	111,208	—	—	—	—	—	—	—
	Q3	0	55,604	111,208	—	—	—	—	—	—	—
	Q4	0	55,604	111,208	—	—	—	—	—	—	—
	Annual	—	55,604	111,208	0	360,519	360,519	—	—	—	—
Paul D. Keswick Executive Vice President, New Product Development	Q1	0	60,879	357,044	—	—	—	—	—	—	—
	Q2	0	60,879	357,044	—	—	—	—	—	—	—
	Q3	0	60,879	357,044	—	—	—	—	—	—	—
	Q4	0	60,879	357,044	—	—	—	—	—	—	—
	Annual	—	52,652	105,303	0	288,416	288,416	—	—	—	—
Christopher A. Seams Executive Vice President, Sales and Marketing	Q1	0	63,154	126,308	—	—	—	—	—	—	—
	Q2	0	63,154	126,308	—	—	—	—	—	—	—
	Q3	0	63,154	126,308	—	—	—	—	—	—	—
	Q4	0	63,154	126,308	—	—	—	—	—	—	—
	Annual	—	63,154	126,308	0	288,416	288,416	—	—	—	—
Dana C. Nazarian Executive Vice President, Memory Products Division	Q1	0	44,794	89,589	—	—	—	—	—	—	—
	Q2	0	44,794	89,589	—	—	—	—	—	—	—
	Q3	0	44,794	89,589	—	—	—	—	—	—	—
	Q4	0	44,794	89,589	—	—	—	—	—	—	—
	Annual	—	44,794	89,589	0	250,164	250,164	—	—	—	—

1. Represents awards granted under KEBP, PBP and DBP, which were earned based on performance in 2012. These columns show the awards that were possible at the threshold, target and maximum levels of performance. The column titled "Non-Equity Incentive Plan Compensation" in the "Summary Compensation" table shows the actual awards earned in 2012 by our Named Executive Officers under these incentive cash plans.
2. Amounts shown do not reflect awards actually received by the Named Executive Officer. Instead, the amounts reported above assume the highest level of performance (100% achievement). The amount of shares actually received by each of the Named Executive Officers is included in the "Option Exercises and Stock Vesting" table in this Proxy Statement.

## OUTSTANDING EQUITY AWARDS

Fiscal Year Ended December 30, 2012

Name and Principal Position	Option Awards <sup>1</sup>					Stock Awards <sup>1</sup>			
	Number of Securities Underlying Unexercised Options (#) Exercisable	Number of Securities Underlying Unexercised Options (#) Unexercisable	Equity Incentive Plan Awards: Number of Securities Underlying Unexercised/Unearned Options (#)	Option Exercise Price (\$)	Option Expiration Date	Number of Shares of Units of Stock Unvested (#)	Market Value of Shares or Units of Stock that Have Not Vested (\$)	Equity Incentive Plan Awards: Number of Unearned Shares, Units or Other Rights that Have Not Vested <sup>2</sup> (#)	Equity Incentive Plan Awards: Market or Payout Value of Unearned Shares, Units or Other Rights that Have Not Vested <sup>3</sup> (\$)
T.J. Rodgers President and Chief Executive Officer	1,442,077	—	—	5.18	1/2/14	—	—	—	—
	1,442,077	—	—	3.53	2/25/15	—	—	—	—
	3,028	—	—	8.83	2/25/15	—	—	—	—
	5,306	—	—	3.53	2/25/15	—	—	—	—
	1,251,093	—	—	3.53	6/30/16	—	—	—	—
Brad W. Buss Executive Vice President, Finance and Administration, Chief Financial Officer	90,699	—	—	3.70	8/15/15	—	—	—	—
	209,016	—	—	3.70	8/15/15	—	—	—	—
	131,847	—	—	3.99	10/27/16	—	—	—	—
	—	—	—	—	—	—	—	—	—
Paul D. Keswick Executive Vice President, New Product Development	18,541	—	—	1.79	3/27/13	—	—	—	—
	247,213	—	—	4.76	10/23/13	—	—	—	—
	37,082	—	—	3.53	2/25/15	—	—	—	—
	123,606	—	—	3.99	10/27/16	—	—	—	—
Christopher A. Seams Executive Vice President, Sales and Marketing	19,365	—	—	4.16	8/22/13	—	—	—	—
	370,819	—	—	5.18	1/2/14	—	—	—	—
	288,415	—	—	3.53	2/25/15	—	—	—	—
	111,245	—	—	3.99	10/27/16	—	—	—	—
Dana C. Nazarian Executive Vice President, Memory Products Division	3,794	—	—	3.99	10/27/16	—	—	—	—
	25,494	1,889	—	4.91	3/8/16	—	—	—	—
	—	—	—	—	—	—	—	—	—

- The grants reported above in the “Option Awards” and “Stock Awards” columns were awarded under our Amended and Restated 1994 Stock Plan. The numbers reflect adjustments made, pursuant to which existing awards were multiplied by the SunPower spin-off ratio of 4.12022 to reflect the change in market value of the Company’s common stock following the distribution to the Company’s stockholders of SunPower Corporation class B common stock in connection with the spin-off.

## OPTION EXERCISES AND STOCK VESTING

Fiscal Year Ended December 30, 2012

Name of Executive Officer	Option Awards		Stock Awards	
	Number of Shares Acquired on Exercise (#)	Value Realized Upon Exercise <sup>1</sup> (\$)	Number of Shares Acquired Upon Vesting (#) <sup>2</sup>	Value Realized Upon Vesting (\$)
T.J. Rodgers	500,000	5,550,550	168,022	1,764,231
Brad W. Buss	—	—	105,013	1,102,637
Paul D. Keswick	—	—	84,011	882,116
Christopher A. Seams	—	—	84,011	882,116
Dana C. Nazarian	—	—	72,869	765,125

1. Amount shown reflects the difference between the option exercise price and the market value of the underlying shares on the exercise date multiplied by the number of shares covered by the option.
2. Amount shown reflects total number of shares that were granted and earned in 2012. The actual amount released to the Named Executive Officers was net of shares withheld to pay the taxes due upon vesting. The actual shares received by Named Executive Officers were substantially less due to required federal and state withholding taxes.

## NON-QUALIFIED DEFERRED COMPENSATION

Fiscal Year Ended December 30, 2012<sup>1</sup>

Name of Executive Officer	Executive Contribution in the Last Fiscal Year (\$)	Registrant Contribution in the Last Fiscal Year (\$)	Aggregate Earnings in the Last Fiscal Year (\$)	Aggregate Withdrawals/Distributions (\$)	Aggregate Balance at Last Fiscal Year End (\$)
T.J. Rodgers	774,234	—	832,716	—	8,876,489
Brad W. Buss	25,055	—	23,244	—	423,338
Paul D. Keswick	—	—	—	—	—
Christopher A. Seams	51,212	—	32,367	—	628,446
Dana C. Nazarian	—	—	34,903	—	264,763

1. There are no guaranteed payments under our deferred compensation plans.

## OTHER DISCLOSURES

### Compensation Committee Interlocks and Insider Participation

During fiscal year 2012, the following directors were members of our Compensation Committee: Mr. Eric A. Benhamou, Mr. Lloyd Carney, and Mr. James R. Long. None of the Compensation Committee members is or has at any time been an officer or employee of Cypress.

None of Cypress's Named Executive Officers serves, or in the past fiscal year served, as a member of the board of directors or compensation committee of any entity that has one or more of its executive officers serving on Cypress's Board or Compensation Committee.

### Policies and Procedures with Respect to Related Person Transactions

We have adopted a policy that provides that any request for us to enter into a transaction with an executive officer, director, principal stockholder, or any of such persons' immediate family members or affiliates, in which the amount involved exceeds \$120,000 must be reviewed and approved by our Audit Committee or other independent members of our Board in the case it is inappropriate for our Audit Committee to review such transaction due to a conflict of interest. All of our directors, executive officers and employees are required to report to our Audit Committee any such related-party transaction. Our Audit Committee considers the relevant facts and circumstances available and deemed relevant to the Audit Committee, including, but not limited to the risks, costs and benefits to us, the terms of the transaction, the availability of other sources for comparable services or products, and, if applicable, the impact on a director's independence.

### Certain Relationships and Related Transactions

In fiscal year 2012, we purchased approximately \$2,265,000 in software and services from Mentor Graphics Corporation ("Mentor Graphics"). Dan McCranie, who sits on our Board of Directors, also sits on the Board of Directors of Mentor Graphics. Mr. McCranie was in no way directly involved in the negotiation of our purchase agreement with Mentor Graphics.

In fiscal year 2012, we sold (primarily through our distribution channel) approximately \$458,000 in products to Technicolor, and approximately \$329,000 in products to Tesla Motors, Inc. ("Tesla"). Lloyd Carney, who sits on our Board of Directors, also sits on the Board of Directors of Technicolor, and Brad Buss, our chief financial officer, sits on the Board of Directors of Tesla. Neither Mr. Carney nor Mr. Buss had any role in determining the price or sale terms to Technicolor or Tesla.

Apart from Mr. Rodgers service on our Board, Mr. McCranie's relationship with Mentor Graphics Corporation, Mr. Carney's relationship with Technicolor, and Mr. Buss's relationship with Tesla, and there are no related parted transactions between our directors or executive officers and our Company. For purposes of this section, "related person" and "transaction" have the meanings contained in Item 404 of Regulation S-K.

### Section 16(a) Beneficial Ownership Reporting Compliance

Section 16(a) of the Securities Exchange Act of 1934, as amended, requires our executive officers and directors, and persons who own more than 10% of a registered class of our equity securities, to file an initial report of ownership on Form 3 and changes in ownership on Form 4 or 5 with the SEC. Such officers, directors and 10% stockholders are also required by the SEC rules to furnish us with copies of all of the forms they filed to comply with Section 16(a) requirements.

We believe that, during fiscal year 2012, our directors, executive officers, and 10% stockholders complied with all Section 16(a) filing requirements.

In making these statements, we have relied upon examination of the copies of Forms 3, 4, and 5, and amendments to these forms, provided to us and the written representations of our directors, executive officers, and 10% stockholders.



## OTHER MATTERS

We know of no other matters to be submitted at the Annual Meeting. If any other matters properly come before the Annual Meeting, it is the intention of the persons named in the enclosed proxy to vote the shares they represent as the Board of Directors may recommend.

It is important that your stock be represented at the Annual Meeting, regardless of the number of shares you hold. You are, therefore, urged to execute and return your proxy card in the envelope provided or to vote by telephone or over the Internet at your earliest convenience.

FOR THE BOARD OF DIRECTORS

A handwritten signature in black ink, appearing to read 'Brad W. Buss', written over a horizontal line.

Brad W. Buss  
*Corporate Secretary*

Dated: March 29, 2013

THIS PAGE INTENTIONALLY LEFT BLANK

**APPENDIX A**  
**CYPRESS SEMICONDUCTOR CORPORATION**  
**2013 STOCK PLAN**

**Amending and Restating the 1994 Stock Plan As of the Date of the 2013 Annual Stockholders Meeting**

**1. PURPOSES OF THE PLAN. THE PURPOSES OF THIS STOCK PLAN ARE:**

- to promote the long-term success of the Company's business;
- to attract and retain the best available personnel for positions of substantial responsibility; and
- to provide long-term incentive to Employees, Consultants and Outside Directors that is aligned with the long-term interest of all stockholders.

**2. COMPONENTS OF THE PLAN. THE PLAN PROVIDES FOR:**

- the discretionary granting of Options, Stock Appreciation Rights, Restricted Stock or Restricted Stock Units to Employees, Consultants and Outside Directors, which Options may be either Incentive Stock Options (for Employees only) or Nonstatutory Stock Options, as determined by the Administrator at the time of grant; and
- the grant of Nonstatutory Stock Options, Stock Appreciation Rights, Restricted Stock or Restricted Stock Units to Outside Directors pursuant to an automatic, non-discretionary formula.

**3. STOCK SUBJECT TO THE PLAN.** The maximum aggregated number of Shares authorized for issuance under the Plan is 145,195,220. The Shares may be authorized, but unissued, or reacquired Common Stock. Any Shares subject to Options or Stock Appreciation Rights shall be counted against the numerical limits of this Section 3 as one Share for every Share subject thereto. [Any Shares of Restricted Stock or Restricted Stock Units with a per Share or unit purchase price lower than 100% of Fair Market Value on the date of grant shall be counted against the numerical limits of this Section 3 as 1.88 Shares for every one Share subject thereto. To the extent that a Share that was subject to an Award that counted as 1.88 Shares against the Plan reserve pursuant to the preceding sentence is recycled back into the Plan under the next paragraph of this Section 3, the Plan shall be credited with 1.88 Shares.

Subject to Section 16 of the Plan, If any Shares that have been subject to an option or SAR (whether granted under this Plan or the Terminated Plans) cease to be subject to such Option or SAR (other than through exercise of the Option or SAR), or if any Option or SAR granted hereunder or thereunder is forfeited, or any Option or SAR otherwise terminates prior to the issuance of Common Stock to the Participant, the Shares that were subject to such Option or SAR shall again be available for distribution in connection with future awards under the Plan (unless the Plan has terminated).

Shares that have actually been issued under the Plan upon exercise of an Option shall not in any event be returned to the Plan and shall not become available for future distribution under the Plan. With respect to SARs, when an SAR is exercised, the full number of shares subject to the SAR or portion thereof being exercised shall be counted against the numerical limits of this Section 3 above as one Share for every Share subject thereto, regardless of the number of Shares used to settle the SAR upon exercise. For example, if an SAR covering 100 shares is exercised by a Participant and the Participant receives 80 Shares (with 20 Shares withheld to cover the SAR exercise price), the Plan Share reserve shall be debited the full 100 Shares and such Shares will not be available for future distribution under the Plan. Similarly, if Shares are withheld to satisfy the minimum statutory withholding obligations arising in connection with the vesting, exercise or issuance of any Award (or delivery of the related Shares), such withheld Shares will not be available for future issuance under the Plan.

Shares of Restricted Stock (including Restricted Stock Units) that do not vest and thus are forfeited back to or repurchased by the Company shall become available for future grant or sale under the Plan (unless the Plan

has terminated). Shares of Restricted Stock or Restricted Stock Units that vest shall not in any event be returned to the Plan and shall not become available for future distribution under the Plan.

Notwithstanding the foregoing and, subject to adjustment as provided in Section 16 of the Plan, the maximum number of Shares that may be issued upon the exercise of Incentive Stock Options will equal the aggregate Share number stated in the first paragraph of Section 3, plus, to the extent allowable under Section 422 of the Code and the Treasury Regulations promulgated thereunder, any Shares that become available for issuance under the Plan pursuant to the second and third paragraphs of this Section 3.

#### 4. ADMINISTRATION OF THE PLAN.

##### 4.1 Procedure.

4.1.1 Multiple Administrative Bodies. The Plan may be administered by different Committees with respect to different groups of Employees, Consultants and Directors.

4.1.2 Section 162(m). To the extent that the Administrator determines it to be desirable to qualify Options granted hereunder as “performance-based compensation” within the meaning of Section 162(m) of the Code, the Plan shall be administered by a Committee of two or more “outside directors” within the meaning of Section 162(m) of the Code.

4.1.3 Rule 16b-3. To the extent desirable to qualify transactions hereunder as exempt under Rule 16b-3, the transactions contemplated hereunder shall be structured to satisfy the requirements for exemption under Rule 16b-3.

4.1.4 Other Administration. Other than as provided above, the Plan shall be administered by (A) the Board or (B) a Committee, which Committee shall be constituted to satisfy Applicable Laws.

4.1.5 Administration With Respect to Automatic Grants to Outside Directors. Automatic grants to Outside Directors shall be pursuant to a non-discretionary formula as set forth in Section 10 hereof and therefore shall not be subject to any discretionary administration.

4.2 Powers of the Administrator. Subject to the provisions of the Plan, and in the case of a Committee, subject to the specific duties delegated by the Board to such Committee, the Administrator shall have the authority, in its discretion:

4.2.1 to determine the Fair Market Value of the Common Stock, in accordance with subsection 23.19 of the Plan;

4.2.2 to select the Consultants, Employees and Outside Directors to whom Options, Stock Appreciation Rights, Restricted Stock or Restricted Stock Units may be granted hereunder;

4.2.3 to determine whether and to what extent Options, Stock Appreciation Rights, Restricted Stock or Restricted Stock Units are granted hereunder;

4.2.4 to determine the number of shares of Common Stock to be covered by each Award granted hereunder;

4.2.5 to approve forms of agreement, including electronic forms, for use under the Plan;

4.2.6 to determine the terms and conditions, not inconsistent with the terms of the Plan, of any Option, Stock Appreciation Right, Restricted Stock or Restricted Stock Unit award granted hereunder. Such terms and conditions include, but are not limited to, the exercise price, the time or times when Options or SARs

may be exercised and when Restricted Stock or Restricted Stock Units vest or are issued (which may, in either case, be based on performance criteria), any vesting acceleration or waiver of forfeiture or repurchase restrictions, any deferral features for Restricted Stock or Restricted Stock Units, including those with performance-based vesting criteria, and any restriction or limitation regarding any Award or the shares of Common Stock relating thereto, based in each case on such factors as the Administrator, in its sole discretion, shall determine;

4.2.7 to construe and interpret the terms of the Plan and Awards granted pursuant to the Plan;

4.2.8 to prescribe, amend and rescind rules and regulations relating to the Plan, including rules and regulations relating to sub-plans established for the purpose of qualifying for preferred tax treatment under foreign tax laws;

4.2.9 to modify or amend each Award (subject to subsection 18.3 of the Plan), including the discretionary authority to extend the post-termination exercisability period of Options or SARs longer than is otherwise provided for in the Plan (but not longer than the original Option or SAR term);

4.2.10 to allow Participants to satisfy withholding tax obligations by electing to have the Company withhold from the Shares to be issued upon exercise of an Option or SAR or the vesting or issuance of Restricted Stock or Restricted Stock Units that number of Shares having a Fair Market Value equal to the minimum statutory amount required to be withheld. The Fair Market Value of the Shares to be withheld shall be determined on the date that the amount of tax to be withheld is to be determined. All elections by a Participant to have Shares withheld for this purpose shall be made in such form and under such conditions as the Administrator may deem necessary or advisable;

4.2.11 to authorize any person to execute on behalf of the Company any instrument required to effect the grant of an Award previously granted by the Administrator;

4.2.12 to determine the terms and restrictions applicable to Awards; and

4.2.13 to make all other determinations deemed necessary or advisable for administering the Plan.

4.3 Effect of Administrator's Decision. The Administrator's decisions, determinations and interpretations shall be final and binding on all Participants and any other holders of Awards.

## 5. ELIGIBILITY.

5.1 Discretionary Awards. Nonstatutory Stock Options, SARs, Restricted Stock and Restricted Stock Unit Awards may be granted to Employees, Consultants and Outside Directors. Incentive Stock Options may be granted only to Employees. If otherwise eligible, an Employee, Consultant or Outside Director who has been granted an Award may be granted additional Awards.

5.2 Outside Director Awards. Outside Directors shall also receive automatically granted Awards pursuant to Section 10 hereof.

## 6. LIMITATIONS.

6.1 Each Option shall be designated in the Notice of Grant or Option Agreement as either an Incentive Stock Option or a Nonstatutory Stock Option. However, notwithstanding such designations, to the extent that the aggregate Fair Market Value:

6.1.1 of Shares subject to a Participant's incentive stock options granted by the Company, any Parent or Subsidiary, which

6.1.2 become exercisable for the first time during any calendar year (under all plans of the Company or any Parent or Subsidiary) exceeds \$100,000, such excess Options shall be treated as Nonstatutory Stock Options. For purposes of this Section 6.1.2, incentive stock options shall be taken into account in the order in which they were granted, and the Fair Market Value of the Shares shall be determined as of the time of grant.

6.2 Neither the Plan nor any Award shall confer upon any Participant any right with respect to continuing the Participant's employment or consulting relationship or tenure as a director with the Company, nor shall they interfere in any way with the Participant's, the Company's, or the Company's stockholders', right to terminate such employment or consulting relationship or tenure as a Director with the Company at any time, with or without cause.

6.3 The following limitations shall apply to grants of Options and SARs to Employees:

6.3.1 No Employee shall be granted, in any fiscal year of the Company, Options and SARs to purchase, in the aggregate, more than 3,000,000 Shares.

6.3.2 The foregoing limitation shall be adjusted proportionately in connection with any change in the Company's capitalization as described in subsection 16.1 and any Spin-Off, split-off or similar transaction involving equity securities of a Subsidiary or former Subsidiary as described in subsection 16.4.

6.3.3 If an Option or SAR is cancelled (other than in connection with a transaction described in Section 16), the cancelled Option or SAR will be counted against the limit set forth in subsection 6.3.1. For this purpose, if the exercise price of an Option or SAR is reduced (which would require prior stockholder approval pursuant to Section 22 hereof), the transaction will be treated as a cancellation of the Option or SAR and the grant of a new Option or SAR.

**7. TERM OF PLAN.** The plan was amended and restated in 2013. It shall continue in effect until January 15, 2024, unless terminated earlier under Section 18 of the plan.

**8. TERM OF OPTION OR SAR.** The term of each option or SAR shall be eight (8) years from the date of grant or such shorter term as may be provided in the notice of grant, option or SAR agreement. In the case of an incentive stock option granted to a participant who, at the time the incentive stock option is granted, owns stock representing more than ten percent (10%) of the voting power of all classes of stock of the company or any parent or subsidiary, the term of the incentive stock option shall be five (5) years from the date of grant or such shorter term as may be provided in the notice of grant or option agreement.

**9. OPTION AND SAR EXERCISE PRICE; OPTION CONSIDERATION.**

9.1 Exercise Price. The per share exercise price for the Shares to be issued pursuant to exercise of an Option or SAR shall be determined by the Administrator, subject to the following:

9.1.1 In the case of an Incentive Stock Option

9.1.1.1 granted to an Employee who, at the time the Incentive Stock Option is granted, owns stock representing more than ten percent (10%) of the voting power of all classes of stock of the Company or any Parent or Subsidiary, the per Share exercise price shall be no less than 110% of the Fair Market Value per Share on the date of grant.

9.1.1.2 granted to any Employee other than an Employee described in paragraph (9.1.1.1) immediately above, the per Share exercise price shall be no less than one hundred (100%) of the Fair Market Value per Share on the date of grant.

9.1.2 In the case of a Nonstatutory Stock Option or an SAR, the per Share exercise price shall be no less than one hundred percent (100%) of Fair Market Value per Share on the date of grant.

9.2 Waiting Period and Exercise Dates. At the time an Option or SAR is granted, the Administrator shall fix the period within which the Option or SAR may be exercised and shall determine any conditions which must be satisfied before the Option or SAR may be exercised. In so doing, the Administrator may specify that an Option or SAR may not be exercised until the completion of a service period or until certain performance milestones are achieved.

9.3 Form of Option Consideration. Except with respect to automatic stock option grants to Outside Directors, the Administrator shall determine the acceptable form of consideration for exercising an Option, including the method of payment. In the case of an Incentive Stock Option, the Administrator shall determine the acceptable form of consideration at the time of grant. Such form of consideration shall be set forth in the Notice of Grant or Option Agreement and may, as determined by the Administrator (and to the extent consistent with Applicable Laws), consist entirely of:

9.3.1 cash;

9.3.2 check;

9.3.3 promissory note;

9.3.4 other previously-owned Shares which have a Fair Market Value on the date of surrender equal to the aggregate exercise price of the Shares as to which said Option shall be exercised;

9.3.5 delivery of a properly executed exercise notice together with such other documentation as the Administrator and the broker, if applicable, shall require to effect an exercise of the Option and delivery to the Company of the sale or loan proceeds required to pay the exercise price;

9.3.6 any combination of the foregoing methods of payment; or

9.3.7 such other consideration and method of payment for the issuance of Shares to the extent permitted by Applicable Laws.

## 10. GRANTS TO OUTSIDE DIRECTORS.

10.1 Procedure for Grants. Each Outside Director shall be granted an Award on the date of his or her initial election and annually thereafter on the date of the annual stockholder meeting (so long as the Outside Director has been serving as such for at least three months), in an amount determined by the Administrator in its sole discretion. Such Awards shall vest and be payable and subject to such other terms and conditions as may be determined by the Administrator.

10.2 Outside Director Award Limitations. No Outside Director may be granted, in any fiscal year of the Company, Awards, with a grant date fair value (determined in accordance with either GAAP or IASB Principles) of more than \$500,000, increased to \$750,000 in connection with his or her initial service.

10.3 Consideration for Exercising Outside Director Stock Options. The consideration to be paid for the Shares to be issued upon exercise of an Outside Director Option (granted on or prior to May 22, 2009) shall consist entirely of cash, check, other Shares of previously owned Common Stock which have a fair market value on the date of surrender equal to the aggregate exercise price of the Shares as to which said Option shall be exercised, and, for Options granted on or after the 2004 Company annual stockholder meeting, to the extent permitted by Applicable Laws, delivery of a properly executed exercise notice together with such other documentation as the Administrator and the broker, if applicable, shall require to effect an exercise of the Option and delivery to the Company of the sale or loan proceeds required to pay the exercise price, or any combination of such methods of payment.

#### 10.4 Post-Directorship Exercisability.

10.4.1 Termination of Status as a Director. If an Outside Director ceases to serve as a Director, he may, but only within ninety (90) days, or, for Options granted on or after the 2004 Company annual stockholder meeting, within one year, after the date he or she ceases to be a Director of the Company, exercise his or her Option to the extent that he or she was entitled to exercise it at the date of such termination. To the extent that he or she was not entitled to exercise an Option at the date of such termination, or if he or she does not exercise such Option (which he was entitled to exercise) within the time specified herein, the Option shall terminate.

10.4.2 Disability of Director. Notwithstanding the provisions of subsection 10.4.1 above, in the event a Director is unable to continue his or her service as a Director with the Company as a result of his or her Disability, he or she may, but only within six (6) months, or, for Options granted on or after the 2004 Company annual stockholder meeting, within one year, from the date of termination, exercise his or her Option to the extent he or she was entitled to exercise it at the date of such termination. To the extent that he or she was not entitled to exercise the Option at the date of termination, or if he or she does not exercise such Option (which he was entitled to exercise) within the time specified herein, the Option shall terminate.

#### 10.4.3 Death of Director. In the event of the death of a Participant:

10.4.3.1 during the term of the Option who is at the time of his death a Director of the Company and who shall have been in Continuous Status as a Director since the date of grant of the Option, the Option may be exercised, at any time within six (6) months, or, for Options granted on or after the 2004 Company annual stockholder meeting, within one year, following the date of death, by the Director's estate or by a person who acquired the right to exercise the Option by bequest or inheritance, but only to the extent of the right to exercise that would have accrued had the Participant continued living and remained in Continuous Status as a Director for twelve (12) months after the date of death; or

10.4.3.2 within thirty (30) days after the termination of Continuous Status as a Director, the Option may be exercised, at any time within six (6) months, or, for Options granted on or after the 2004 Company annual stockholder meeting, within one year, following the date of death, by the Participant's estate or by a person who acquired the right to exercise the Option by bequest or inheritance, but only to the extent of the right to exercise that had accrued at the date of termination.

### 11. EXERCISE OF OPTION OR SAR.

11.1 Procedure for Exercise; Rights as a Stockholder. Any Option or SAR granted hereunder shall be exercisable according to the terms of the Plan and at such times and under such conditions as determined by the Administrator and set forth in the Option or SAR Agreement. An Option or SAR may not be exercised for a fraction of a Share.

An Option or SAR shall be deemed exercised when the Company receives: (i) written or electronic notice of exercise (in accordance with the Option Agreement) from the person entitled to exercise the Option, and (ii) for Options only, full payment for the Shares with respect to which the Option is exercised. Full payment for Options may consist of any consideration and method of payment authorized by the Administrator and permitted by the Option Agreement and the Plan. Shares issued upon exercise of an Option or SAR shall be issued in the name of the Participant or, if requested by the Participant, in the name of the Participant and his or her spouse. Until the stock certificate evidencing such Shares is issued (as evidenced by the appropriate entry on the books of the Company or of a duly authorized transfer agent of the Company), no right to vote or receive dividends or any other rights as a stockholder shall exist with respect to the Optioned Stock, notwithstanding the exercise of the Option or SAR. The Company shall issue (or cause to be issued) such stock certificate promptly after the Option or SAR is exercised. No adjustment will be made for a dividend or other right for which the record date is prior



to the date the stock certificate is issued, except as provided in Section 16 of the Plan. Exercising an Option or SAR in any manner shall decrease the number of Shares thereafter available for sale under the Option or SAR by the number of Shares as to which the Option or SAR is exercised.

11.2 Termination of Service. Upon termination of a Participant's Continuous Status as an Employee, Consultant or Director, other than upon the Participant's death or Disability, the Participant may exercise the Option or SAR, but only within such period of time as is specified in the Notice of Grant, Option or SAR Agreement, and, unless otherwise determined by the Administrator, only to the extent that the Participant was entitled to exercise it at the date of termination (but in no event later than the expiration of the term of such Option as set forth in the Notice of Grant or Option Agreement). In the absence of a specified time in the Notice of Grant, Option or SAR Agreement, the Option or SAR shall remain exercisable for thirty days following the Participant's termination of Continuous Status as an Employee, Consultant or Director. If, at the date of termination, the Participant is not entitled to exercise the entire Option or SAR, the Shares covered by the unexercisable portion of the Option or SAR shall revert to the Plan. If, after termination, the Participant does not exercise the Option or SAR within the time specified by the Administrator, the Option or SAR shall terminate, and the Shares covered by such Option or SAR shall revert to the Plan.

11.3 Disability of Participant. In the event that a Participant's Continuous Status as an Employee, Consultant or Director terminates as a result of the Participant's Disability, the Participant may exercise his or her Option or SAR at any time within six (6) months or such other period of time not exceeding twelve (12) months, as is specified in the Notice of Grant, Option or SAR Agreement, except in the case of stock option grants to Outside Directors, which shall be exercised as specified in Section 10. Unless otherwise determined by the Administrator, any such Options or SARs may only be exercised to the extent that the Participant was entitled to exercise it at the date of such termination (but in no event later than the expiration of the term of such Option or SAR as set forth in the Notice of Grant, Option or SAR Agreement). If, at the date of termination, the Participant is not entitled to exercise his or her entire Option or SAR, the Shares covered by the unexercisable portion of the Option or SAR shall revert to the Plan. If, after termination, the Participant does not exercise his or her Option or SAR within the time specified herein, the Option or SAR shall terminate, and the Shares covered by such Option or SAR shall revert to the Plan.

11.4 Death of Participant. In the event of the death of a Participant (other than an Outside Director with respect to his or her stock option grant):

11.4.1 during the term of the Option or SAR who is at the time of his or her death an Employee, Consultant or Director of the Company and who shall have been in Continuous Status as an Employee, Consultant or Director since the date of grant of the Option or SAR, the Option or SAR may be exercised, at any time within six (6) months following the date of death, by the Participant's estate or by a person who acquired the right to exercise the Option or SAR by bequest or inheritance, but only to the extent of the right to exercise that would have accrued had the Participant continued living and remained in Continuous Status as an Employee, Consultant or Director for twelve (12) months after the date of death; or

11.4.2 within thirty (30) days after the termination of Continuous Status as an Employee, Consultant or Director, the Option or SAR may be exercised, at any time within six (6) months following the date of death, by the Participant's estate or by a person who acquired the right to exercise the Option or SAR by bequest or inheritance, but only to the extent of the right to exercise that had accrued at the date of termination.

## 12. STOCK APPRECIATION RIGHTS.

12.1 The SAR shall entitle the Participant, by exercising the SAR, to receive from the Company an amount equal to the excess of (x) the Fair Market Value of the Common Stock covered by exercised portion of the SAR, as of the date of such exercise, over (y) the Fair Market Value of the Common Stock covered by the exercised portion of the SAR, as of the date on which the SAR was granted; provided, however, that the Administrator may place limits on the amount that may be paid upon exercise of a SAR; and

12.2 SARs shall be exercisable, in whole or in part, at such times as the Administrator shall specify in the Participant's Award Agreement;

12.3 Form of Payment. The Company's obligation arising upon the exercise of a SAR may be paid in Common Stock or in cash, or in any combination of Common Stock and cash, as the Administrator, in its sole discretion, may determine, but only as specified in the Notice of Grant or SAR Agreement. Shares issued upon the exercise of a SAR shall be valued at their Fair Market Value as of the date of exercise.

12.4 Rule 16b-3. SARs granted hereunder shall contain such additional restrictions as may be required to be contained in the Plan or Award Agreement in order for the SAR to qualify for the maximum exemption provided by Rule 16b-3.

### **13. RESTRICTED STOCK/RESTRICTED STOCK UNITS.**

13.1 Grant of Restricted Stock/Restricted Stock Units. Subject to the terms and conditions of the Plan, Restricted Stock or Restricted Stock Units may be granted to Employees, Consultants and Outside Directors at any time and from time to time as shall be determined by the Administrator, in its sole discretion. The Administrator shall have complete discretion to determine (i) the number of Shares subject to a Restricted Stock or Restricted Stock Unit Award granted to any Participant (provided that during any Fiscal Year, no Participant shall receive more than 1,500,000 Shares in the aggregate of Restricted Stock or Restricted Stock Unit Awards) (ii) whether the form of the award shall be Shares or rights to acquire Shares (i.e., Restricted Stock Units), and (iii) the conditions that must be satisfied, which may include or consist entirely of performance-based milestones, upon which is conditioned the grant or vesting of Restricted Stock or Restricted Stock Units. The foregoing limitation in subsection 13.1.1(i) shall be adjusted proportionately in connection with any change in the Company's capitalization as described in subsection 16.1 and any Spin-Off, split-off or similar transaction involving equity securities of a Subsidiary or former Subsidiary as described in subsection 16.4. For Restricted Stock Units, each such unit shall be the equivalent of one Share of Common Stock for purposes of determining the number of Shares subject to an Award. Until the stock certificate evidencing such Shares is issued (as evidenced by the appropriate entry on the books of the Company or of a duly authorized transfer agent of the Company), no right to vote or receive dividends or any other rights as a stockholder shall exist with respect to the Restricted Stock or Restricted Stock Unit, notwithstanding its vesting. Except with respect to Restricted Stock or Restricted Stock Units with a deferral feature and where delivery has been deferred to a time after the vesting date, as permitted by the Administrator in its sole discretion, the Company shall issue (or cause to be issued) such stock certificate promptly after the Restricted Stock or Restricted Stock Unit vests. No adjustment will be made for a dividend or other right for which the record date is prior to the date the stock certificate is issued, except as provided in Section 16 of the Plan and except that Restricted Stock and Restricted Units that have already vested but have not yet been delivered due to the Participant's election to defer their delivery shall be credited with all dividends and other distributions relating to shares of Stock, which shall be delivered to such Participants simultaneously with the delivery of their deferred shares of Stock.

13.2 Other Terms. The Administrator, subject to the provisions of the Plan, shall have complete discretion to determine the terms and conditions of Restricted Stock and Restricted Stock Unit Awards granted under the Plan. Restricted Stock and Restricted Stock Unit Awards shall be subject to the terms, conditions, and restrictions determined by the Administrator at the time of grant, which may include such performance-based milestones as are determined appropriate by the Administrator, which may be Performance Goals, or for Restricted Stock or Restricted Stock Unit Awards not intended to qualify as "performance-based compensation" under Code Section 162(m), may be other performance-based milestones. The Administrator may require the recipient to sign a Restricted Stock or Restricted Stock Unit Agreement as a condition of the Award. Any certificates representing the shares of Stock awarded shall bear such legends as shall be determined by the Administrator.

13.3 Restricted Stock or Restricted Stock Unit Award Agreement. Each Restricted Stock or Restricted Stock Unit grant shall be evidenced by an Award agreement that shall specify the purchase price (if

any) and such other terms and conditions as the Administrator, in its sole discretion, shall determine; provided; however, that if the Restricted Stock or Restricted Stock Unit Award has a purchase price, such purchase price must be paid no later than the earlier of (i) eight (8) years following the date of grant, or (ii) the vesting date.

13.4 Section 162(m) Performance Restrictions. For purposes of qualifying grants of Restricted Stock or Restricted Stock Units as “performance-based compensation” under Section 162(m) of the Code, the Administrator, in its discretion, may set restrictions based upon the achievement of Performance Goals. The Performance Goals shall be set by the Administrator on or before the latest date permissible to enable the Restricted Stock or Restricted Stock Units to qualify as “performance-based compensation” under Section 162(m) of the Code. In granting Restricted Stock or Restricted Stock Units which is intended to qualify under Section 162(m) of the Code, the Administrator shall follow any procedures determined by it from time to time to be necessary or appropriate to ensure qualification of the Restricted Stock under Section 162(m) of the Code (e.g., in determining the Performance Goals).

13.5 Restricted Stock/Restricted Stock Unit Deferrals. The Administrator, in its sole discretion, may permit Participants to defer the settlement of Restricted Stock or Restricted Stock Units in accordance with Code Section 409A and with rules and procedures established by the Administrator. Any deferred Restricted Stock or Restricted Stock Units shall remain subject to the claims of the Company’s general creditors until distributed to the Participant.

**14. LEAVES OF ABSENCE.** Unless the administrator provides otherwise, and subject to applicable laws, vesting of awards granted hereunder shall cease during any unpaid leave of absence. Moreover, unless the administrator provides otherwise, any employee who transfers his or her employment to a subsidiary and receives an equity incentive covering such subsidiary’s equity securities in connection with such transfer, shall cease vesting in awards granted under this plan until such time, if any, as such employee transfers from the employ of such subsidiary or another subsidiary directly back to the employ of the company.

**15. TRANSFERABILITY OF AWARDS.** An Award may not be sold, pledged, assigned, hypothecated, transferred, or disposed of in any manner other than by will or by the laws of descent or distribution and may be exercised, during the lifetime of the participant, only by the participant; provided, however, that the Administrator, in its discretion, may permit the transfer of Awards to living trusts or other estate planning entities as permitted under Form S-8 promulgated under the Securities Act of 1933. If the administrator makes an Award transferable, such Award shall contain such additional terms and conditions as the administrator deems appropriate; provided, however, that in no event may an Award be transferred in exchange for consideration.

**16. ADJUSTMENTS UPON CHANGES IN CAPITALIZATION OR SIMILAR TRANSACTION, DISSOLUTION, MERGER, ASSET SALE OR CHANGE OF CONTROL.**

16.1 Changes in Capitalization. Subject to any required action by the stockholders of the Company, the number of shares of Common Stock covered by each outstanding Award (including deferred Restricted Stock and Restricted Stock Unit Awards that have not been settled), and the number of shares of Common Stock which have been authorized for issuance under the Plan but as to which no Awards have yet been granted or which have been returned to the Plan upon cancellation or expiration of an Award or forfeiture or repurchase of unvested Restricted Stock or Restricted Stock Units, the price per share, if any, of Common Stock covered by each such outstanding Award, the limit on the number of Shares subject to an Option or SAR that may be granted to an Employee in any fiscal year under subsection 6.3.1, as well as the limit of the number of Shares that may be issued as Restricted Stock or Restricted Stock Unit Awards under subsection 13.1, shall be proportionately adjusted for any increase or decrease in the number of issued shares of Common Stock resulting from a stock split, reverse stock split, stock dividend, combination or reclassification of the Common Stock, or any other increase or decrease in the number of issued shares of Common Stock effected without receipt of consideration by the Company; provided, however, that conversion of any convertible securities of the Company shall not be deemed to have been “effected without receipt of consideration.” Such adjustment shall be made by

the Board, whose determination in that respect shall be final, binding and conclusive. Except as expressly provided herein, no issuance by the Company of shares of stock of any class, or securities convertible into shares of stock of any class, shall affect, and no adjustment by reason thereof shall be made with respect to, the number or price of shares of Common Stock subject to an Option or Restricted Stock award.

16.2 Dissolution or Liquidation. In the event of the proposed dissolution or liquidation of the Company, with respect to discretionary Awards granted under the Plan (but not with respect to Awards granted to Outside Directors) the Board may, in the exercise of its sole discretion in such instances, declare that any such Award shall terminate as of a date fixed by the Board and give each Participant the right to exercise his or her Option or SAR as to all or any part of the Optioned Stock, including Shares as to which the Option would not otherwise be exercisable or accelerate the vesting of a Participant's Restricted Stock or Restricted Stock Unit Award.

16.3 Merger or Asset Sale. In the event of a merger of the Company with or into another corporation, or the sale of substantially all of the assets of the Company, each outstanding Award shall be assumed or an equivalent Award shall be substituted by the successor corporation or a Parent or Subsidiary of the successor corporation. With respect to a discretionary Award granted under the Plan (but not with respect to Options granted to Outside Directors under Section 10), the Administrator may, in the exercise of its sole discretion and in lieu of such assumption or substitution, provide for the Participant to have the right to exercise such Option or SAR as to all of the Optioned Stock, including as to Shares which would not otherwise be exercisable or provide for the accelerated vesting of Restricted Stock or Restricted Stock Units. With respect to Options and restricted stock units granted to Outside Directors under Section 10, in the event that the successor corporation does not agree to assume such Options and restricted stock units or to substitute equivalent options or rights, each such outstanding Option and restricted stock unit shall become fully vested and exercisable, including as to Shares and units as to which it would not otherwise be exercisable, unless the Board, in its discretion, determines otherwise.

If the Administrator makes a discretionary Option or SAR fully exercisable in lieu of assumption or substitution in the event of a merger or sale of assets, the Administrator shall notify the Participant that the Option or SAR shall be fully exercisable for a period of thirty (30) days from the date of such notice, and the Option or SAR will terminate upon the expiration of such period.

For the purposes of this subsection, the Award shall be considered assumed if, following the merger or sale of assets, the Award confers the right to purchase (or, in the case of Restricted Stock or Restricted Stock Units without a purchase price, receive), for each Share subject to the Award immediately prior to the merger or sale of assets, the consideration (whether stock, cash, or other securities or property) received in the merger or sale of assets by holders of Common Stock for each Share held on the effective date of the transaction (and if holders were offered a choice of consideration, the type of consideration chosen by the holders of a majority of the outstanding Shares); provided, however, that if such consideration received in the merger or sale of assets was not solely common stock of the successor corporation or its Parent, the Administrator may, with the consent of the successor corporation, provide for the consideration to be received upon the exercise of the Option or SAR or vesting of the Restricted Stock or Restricted Stock Unit Award, for each Share subject to the Award, to be solely common stock of the successor corporation or its Parent equal in fair market value to the per share consideration received by holders of Common Stock in the merger or sale of assets.

16.4 Spin-Off or Split-Off. Subject to any required action by the stockholders of the Company, the number and/or type of shares of covered by each outstanding Award (including deferred Restricted Stock and Restricted Stock Unit Awards that have not been settled), the number and/or type of shares which have been authorized for issuance under the Plan but as to which no Awards have yet been granted or which have been returned to the Plan upon cancellation or expiration of an Award or forfeiture or repurchase of unvested Restricted Stock or Restricted Stock Units, the price per share, if any, of Common Stock covered by each such outstanding Award and the limit on the number of Shares subject to an Option or SAR that may be granted to an

Employee in any fiscal year under subsection 6.3.1, as well as the limit of the number of Shares that may be issued as Restricted Stock or Restricted Stock Unit Awards under subsection 13.1 shall be appropriately and proportionately adjusted to account for any increase or diminution in value of an Award resulting from a Spin-Off, split-off or similar transaction involving equity securities of a Subsidiary or former Subsidiary. Any such automatic and non-discretionary adjustment or action shall be made by the Board, whose determination in that respect shall be final, binding and conclusive.

**17. AWARD GRANT DATE.** The date of grant of an award shall be, for all purposes, the date on which the administrator makes the determination granting such option or restricted stock award, or such other later date as is determined by the administrator. Notice of the determination shall be provided to each participant within a reasonable time after the date of such grant.

**18. AMENDMENT AND TERMINATION OF THE PLAN.**

18.1 Amendment and Termination. The Board may at any time amend, alter, suspend or terminate the Plan.

18.2 Stockholder Approval. The Company shall obtain stockholder approval of any Plan amendment to the extent necessary and desirable to comply with Applicable Laws. Shares may not be added to the Plan (other than pursuant to Sections 3 or 16.1 hereof) without obtaining stockholder approval.

**19. EFFECT OF AMENDMENT OR TERMINATION.** No amendment, alteration, suspension or termination of the Plan shall impair the rights of any Participant, unless mutually agreed otherwise between the Participant and the Administrator, which agreement must be in writing and signed by the Participant and the Company.

**20. CONDITIONS UPON ISSUANCE OF SHARES.**

20.1 Legal Compliance. Shares shall not be issued pursuant to the exercise of an Option or SAR or vesting of a Restricted Stock or Restricted Stock Unit Award unless the exercise of such Option or SAR or vesting of such Restricted Stock or Restricted Stock Unit Award and the issuance and delivery of such Shares shall comply with Applicable Laws and shall be further subject to the approval of counsel for the Company with respect to such compliance.

20.2 Investment Representations. As a condition to the exercise of an Option or SAR or purchase of Restricted Stock or Restricted Stock Unit, the Company may require the person exercising such Option or SAR or purchasing such Restricted Stock or Restricted Stock Unit to represent and warrant at the time of any such exercise or purchase that the Shares are being purchased only for investment and without any present intention to sell or distribute such Shares if, in the opinion of counsel for the Company, such a representation is required.

**21. LIABILITY OF COMPANY.**

21.1 Inability to Obtain Authority. The inability of the Company to obtain authority from any regulatory body having jurisdiction, which authority is deemed by the Company's counsel to be necessary to the lawful issuance and sale of any Shares hereunder, shall relieve the Company of any liability in respect of the failure to issue or sell such Shares as to which such requisite authority shall not have been obtained.

21.2 Awards Exceeding Allotted Shares. If the Shares covered by an Award exceed, as of the date of grant, the number of Shares which may be issued under the Plan without additional stockholder approval, such Award shall be void with respect to such excess Shares, unless stockholder approval of an amendment sufficiently increasing the number of Shares subject to the Plan is timely obtained in accordance with subsection 18.2 of the Plan.

**22. RESERVATION OF SHARES.** The Company, during the term of this Plan, will at all times reserve and keep available such number of shares as shall be sufficient to satisfy the requirements of the Plan.

**23. UNDERWATER OPTION EXCHANGES.** The Administrator may not permit the repricing, including by way of exchange, of any Award, without receiving prior stockholder approval.

**24. DEFINITIONS.** As used herein, the following definitions shall apply:

24.1 “Administrator” means the Board or any of its Committees as shall be administering the Plan, in accordance with Section 4 of the Plan.

24.2 “Applicable Laws” means the legal requirements relating to the administration of stock option plans under federal and state corporate and securities laws, the Code and any stock exchange on which the Common Stock is listed or quoted.

24.3 “Award” means an award hereunder of an Option, Stock Appreciation Right, Restricted Stock or Restricted Stock Unit.

24.4 “Board” means the Board of Directors of the Company.

24.5 “Code” means the Internal Revenue Code of 1986, as amended.

24.6 “Committee” means a committee appointed by the Board or its Compensation Committee in accordance with Section 4 of the Plan.

24.7 “Common Stock” means the Common Stock of the Company.

24.8 “Company” means Cypress Semiconductor Corporation, a Delaware corporation.

24.9 “Consultant” means any person, including an advisor, engaged by the Company or a Parent or Subsidiary to render services and who is compensated for such services; provided, however, that the term “Consultant” shall not include Outside Directors, unless such Outside Directors are compensated for services to the Company other than through payment of director’s fees.

24.10 “Continuous Status as a Director” means that the Director relationship is not interrupted or terminated.

24.11 “Continuous Status as an Employee, Consultant or Director” means that the employment, consulting or Director relationship with the Company or any Parent or Subsidiary is not interrupted or terminated. Continuous Status as an Employee, Consultant or Director shall not be considered interrupted in the case of: (i) any leave of absence approved by the Company, including sick leave, military leave, or any other personal leave; provided, however, that for purposes of Incentive Stock Options, no such leave may exceed ninety (90) days, unless reemployment upon the expiration of such leave is guaranteed by contract (including certain Company policies) or statute; provided, further, that on the ninety-first (91st) day of any such leave (where reemployment is not guaranteed by contract or statute) the Participant’s Incentive Stock Option shall cease to be treated as an Incentive Stock Option and will be treated for tax purposes as a Nonstatutory Stock Option; or (ii) transfers between locations of the Company or between the Company, its Parent, its Subsidiaries or its successor.

24.12 “Director” means a member of the Board.

24.13 “Disability” means total and permanent disability as defined in Section 22(e)(3) of the Code.

24.14 “Employee” means any person, including Officers and Directors, employed by the Company or any Parent or Subsidiary of the Company. Neither service as a Director nor payment of a director’s fee by the Company shall be sufficient to constitute “employment” by the Company.

24.15 “Exchange Act” means the Securities Exchange Act of 1934, as amended.

24.16 “Fair Market Value” means, as of any date, the value of Common Stock determined as follows:

24.16.1 If the Common Stock is listed on any established stock exchange or a national market system, including without limitation the New York Stock Exchange, the Nasdaq Global Select Market, the Nasdaq Global Market or the Nasdaq Capital Market of The Nasdaq Stock Market, the Fair Market Value of a Share of Common Stock shall be the closing sale price for such stock (or the mean of the closing bid and asked prices, if no sales were reported), as quoted on such exchange (or the exchange with the greatest volume of trading in Common Stock) or system on the date of such determination (or, in the event such date is not a trading day, the trading day immediately prior to the date of such determination), as reported in The Wall Street Journal or such other source as the Administrator deems reliable; or

24.16.2 If the Common Stock is regularly quoted by a recognized securities dealer but selling prices are not reported, the Fair Market Value of a Share of Common Stock shall be the mean of the closing bid and asked prices for such stock on the date of such determination (or, in the event such date is not a trading day, the trading day immediately prior to the date of such determination), as reported in The Wall Street Journal or such other source as the Administrator deems reliable; or

24.16.3 In the absence of an established market for the Common Stock, the Fair Market Value shall be determined in good faith by the Administrator.

24.17 “Incentive Stock Option” means an Option intended to qualify as an incentive stock option within the meaning of Section 422 of the Code and the regulations promulgated thereunder.

24.18 “Nonstatutory Stock Option” means an Option not intended to qualify as an Incentive Stock Option.

24.19 “Notice of Grant” means a written notice evidencing certain terms and conditions of an individual Option grant. The Notice of Grant is part of the Option Agreement.

24.20 “Officer” means a person who is an officer of the Company within the meaning of Section 16 of the Exchange Act and the rules and regulations promulgated thereunder.

24.21 “Option” means a stock option granted pursuant to the Plan or the Terminated Plans.

24.22 “Option Agreement” means a written agreement between the Company and a Participant evidencing the terms and conditions of an individual Option grant. The Option Agreement is subject to the terms and conditions of the Plan.

24.23 “Optioned Stock” means the Common Stock subject to an Option or SAR.

24.24 “Outside Director” means a Director who is not an Employee or Consultant.

24.25 “Parent” means a “parent corporation”, whether now or hereafter existing, as defined in Section 424(e) of the Code.

24.26 “Participant” means an Employee, Consultant or Outside Director who holds an outstanding Option or Restricted Stock award.

24.27 “Performance Goals” means the goal(s) (or combined goal(s)) determined by the Administrator (in its discretion) to be applicable to a Participant with respect to an Award. As determined by the Administrator, the performance measures for any performance period will be any one or more of the following objective performance criteria, applied to either the Company as a whole or, except with respect to stockholder return metrics, to a region, business unit, affiliate or business segment, and measured either on an absolute basis or relative to a pre-established target, to a previous period’s results or to a designated comparison group, and, with respect to financial metrics, which may be determined in accordance with United States Generally Accepted Accounting Principles (“GAAP”), in accordance with accounting principles established by the International Accounting Standards Board (“IASB Principles”) or which may be adjusted when established to exclude any items otherwise includable under GAAP or under IASB Principles or to include any items otherwise excludable under GAAP or under IASB Principles: (i) cash flow (including operating cash flow or free cash flow), (ii) revenue (on an absolute basis or adjusted for currency effects), (iii) gross margin, (iv) operating expenses or operating expenses as a percentage of revenue, (v) earnings (which may include earnings before interest and taxes, earnings before taxes and net earnings), (vi) earnings per share, (vii) stock price, (viii) return on equity, (ix) total stockholder return, (x) growth in stockholder value relative to the moving average of the S&P 500 Index, the Philadelphia Semiconductor Sector Index or another index, (xi) return on capital, (xii) return on assets or net assets, (xiii) return on investment, (xiv) economic value added, (xv) operating profit or net operating profit, (xvi) operating margin, (xvii) market share, (xviii) contract awards or backlog, (xix) overhead or other expense reduction, (xx) credit rating, (xxi) objective customer indicators, (xxii) new product invention or innovation, (xxiii) attainment of research and development milestones, (xxiv) improvements in productivity, (xxv) attainment of objective operating goals, and (xxvi) objective employee metrics.

24.28 “Plan” means this 2013 Stock Plan, as amended.

24.29 “Restricted Stock/RSUs” means shares of Common Stock granted pursuant to Section 12 of the Plan.

24.30 “Rule 16b-3” means Rule 16b-3 of the Exchange Act or any successor to Rule 16b-3, as in effect when discretion is being exercised with respect to the Plan.

24.31 “Stock Appreciation Right” or “SAR” means a Stock Appreciation Right granted pursuant to Section 12 of the Plan.

24.32 “Share” means a share of the Common Stock, as adjusted in accordance with Section 16 of the Plan.

24.33 “Subsidiary” means a “subsidiary corporation”, whether now or hereafter existing, as defined in Section 424(f) of the Code.



**APPENDIX B**  
**CYPRESS SEMICONDUCTOR CORPORATION**  
**EMPLOYEE STOCK PURCHASE PLAN**

---

Amended and Restated As of the Date of the 2013 Annual Stockholders Meeting

The following constitute the provisions of the Employee Stock Purchase Plan (herein called the “Plan”) of Cypress Semiconductor Corporation (herein called the “Company”).

1. **PURPOSE.** The purpose of the Plan is to provide employees of the Company and its designated subsidiaries with an opportunity to purchase common stock of the Company through accumulated payroll deductions. This Plan includes two components: a Code Section 423 Plan Component and a Non-423 Plan Component. It is the intention of the Company to have the Code Section 423 Plan Component qualify as an “Employee Stock Purchase Plan” under Section 423 of the Code and the provisions of the Plan with respect to the Code Section 423 Component, accordingly, shall be construed so as to extend and limit participation in a manner consistent with the requirements of that section of the Code. In addition, this Plan authorizes the grant of options under the Non-423 Plan Component that do not qualify under Section 423 of the Code, pursuant to the rules, procedures or sub-plans adopted by the Administrator that are designed to achieve tax, securities laws or other objectives for Employees and/or the Company. Except as otherwise indicated, the Non-423 Plan Component will operate and be administered in the same manner as the Code Section 423 Plan Component.
2. **DEFINITIONS.**
  - 2.1 “Act” shall mean the Securities Exchange Act of 1934, as amended.
  - 2.2 “Administrator” shall mean the Board of the company or any committee of the members of the Board authorized to administer the Plan.
  - 2.3 “Board” shall mean the Board of Directors of the Company.
  - 2.4 “Code” shall mean the Internal Revenue Code of 1986, as amended.
  - 2.5 “Code Section 423 Plan Component” shall mean the component of this Plan that is intended to meet the requirements set forth in Section 423(b) of the Code. The Code Section 423 Plan Component shall be construed, administered and enforced in accordance with Section 423(b) of the Code.
  - 2.6 “Common Stock” shall mean the Common Stock of the Company.
  - 2.7 “Company” shall mean Cypress Semiconductor Corporation, a Delaware corporation.
  - 2.8 “Compensation” shall mean all regular straight time earnings, payments for overtime, shift premium, cash incentive compensation, cash incentive payments, cash bonuses and commissions (except to the extent that the exclusion of any such items for all participants is specifically directed by the Board or its committee). The Administrator shall have the discretion to determine what constitutes Compensation for Employees under the Plan, but for purposes of Employees participating in the Code Section 423 Plan Component, such determination will be applied on a uniform, non-discriminatory basis.
  - 2.9 “Continuous Status as an Employee” shall mean the absence of any interruption or termination of service as an Employee. Continuous Status as an Employee shall not be considered interrupted in the case of a leave of absence agreed to in writing by the Company, provided that such leave is for a period of not more than 90 days or reemployment upon the expiration of such leave is guaranteed by contract or statute.
  - 2.10 “Designated Subsidiaries” shall mean the Subsidiaries which have been designated by the Board from time to time in its sole discretion as eligible to participate in the Plan. The Administrator may provide that any Designated Subsidiary shall only be eligible to participate in the Non- 423 Plan

Component and at any given time, a Subsidiary that is a Designated Subsidiary under the Code Section 423 Plan Component shall not be a Designated Subsidiary under the Non-423 Plan Component.

- 2.11 “Employee” shall mean any person, including an officer, who is customarily employed for at least twenty (20) hours per week in a calendar year by the Company or one of its Designated Subsidiaries; provided, however that any temporary or contingency work shall not be included in this definition or be permitted to participate under the Plan. For Offering Periods under the Non-423 Plan Component, Employee shall also mean any other employee of Company or one of its Designated Subsidiaries to the extent that applicable law requires participation in the Plan to be extended to such employee, as determined by the Administrator; unless such employee resides in a country that has been specifically excluded from participation in the Non-423 Component at the discretion of the Administrator.
- 2.12 “Exercise Date” shall mean the first Trading Day on or after December 31 and June 30 of each year.
- 2.13 “Exercise Period” shall mean the approximately six (6) month period commencing on one Exercise Date and ending with the next Exercise Date, except that the first Exercise Period of any Offering Period shall commence on the Offering Date and end with the next Exercise Date.
- 2.14 “Non-423 Plan Component” shall mean a component of this Plan that is not intended to meet the requirements set forth in Section 423(b) of the Code.
- 2.15 “Offering Period” shall mean a period of approximately eighteen (18) months during which an option granted pursuant to the Plan may be exercised, commencing on the first Trading Day on or after December 31 and June 30 of each year and terminating on the Offering Period commencement date approximately eighteen months later.
- 2.16 “Offering Date” shall mean the first Trading Day of each Offering Period of the Plan.
- 2.17 “Plan” shall mean this Employee Stock Purchase Plan, which includes a Code Section 423(b) Plan and a non-423(b) Component.
- 2.18 “Subsidiary” shall mean a corporation, domestic or foreign, of which not less than 50% of the voting shares are held by the Company or a Subsidiary, whether or not such corporation now exists or is hereafter organized or acquired by the Company or a Subsidiary.
- 2.19 “Trading Day” shall mean a day on which national stock exchanges and the Nasdaq System are open for trading.

### **3. ELIGIBILITY.**

- 3.1 Any Employee as defined in paragraph 2 who is employed by the Company as of an Offering Date shall be eligible to participate in the Plan; provided that for purposes of Participants participating in the Code Section 423 Plan Component, this rule will be applied on a uniform and non-discriminatory basis.
- 3.2 Employees who are citizens or residents of a non-U.S. jurisdiction (without regard to whether they also are citizens or residents of the United States or resident aliens (within the meaning of Section 7701(b)(1)(A) of the Code)) may be excluded from participation in the Plan or an Offering Period if the participation of such Employees is prohibited under the laws of the applicable jurisdiction or if complying with the laws of the applicable jurisdiction would cause the Plan or an Offering to violate Section 423 of the Code.
- 3.3 No Employee shall be eligible to participate in the Non-423(b) Component of the Plan if he or she is an officer or director of the Company subject to the requirements of Section 16 of the U.S. Securities Exchange Act of 1934, as amended.
- 3.4 Any provisions of the Plan to the contrary notwithstanding, no Employee shall be granted an option under the Plan (i) if, immediately after the grant, such Employee (or any other person whose stock would be attributed to such Employee pursuant to Section 424(d) of the Code) would own stock and/or

hold outstanding options to purchase stock possessing five percent (5%) or more of the total combined voting power or value of all classes of stock of the Company or of any subsidiary of the Company, or (ii) which permits his rights to purchase stock under all employee stock purchase plans of the Company and its subsidiaries to accrue at a rate which exceeds Twenty-Five Thousand Dollars (\$25,000) of fair market value of such stock determined at the time such option is granted) for each calendar year in which such option is outstanding at any time.

4. OFFERING PERIODS. The Plan shall be implemented by eighteen (18) month Offering Periods beginning approximately every six (6) months with a new Offering Period commencing on the first trading day on or after December 31 and June 30 each year, or on such other date as the Board shall determine. The Plan shall continue thereafter until terminated in accordance with paragraph 20 hereof. Subject to the requirements of paragraph 20, the Board shall have the power to change the duration of offering periods with respect to future offerings without stockholder approval if such change is announced at least fifteen (15) days prior to the scheduled beginning of the first offering period to be affected.

5. PARTICIPATION.

5.1 An eligible Employee may become a participant in the Plan by completing a subscription agreement authorizing payroll deduction on the form provided by the Company and filing it with the Company's payroll office prior to the applicable Offering Date, unless a later time for filing the subscription agreement is set by the Board for all eligible Employees with respect to a given offering; provided that Employees participating in the Non-423 Component may contribute funds to participate in the Plan through other means specified by the Administrator to comply with non-U.S. requirements. For purposes of Employees participating in the Code Section 423 Plan Component, the processing of enrollments, whether on-line or via hard copy, will be applied on a uniform and non-discriminatory basis.

5.2 Payroll deductions for a participant shall commence on the first payroll following the Offering Date and shall end on the Exercise Date of the offering to which such authorization is applicable, unless sooner terminated by the participant as provided in paragraph 11.

6. PAYROLL DEDUCTIONS.

6.1 At the time a participant files his subscription agreement, he shall elect to have payroll deductions made on each payday during the Offering Period in amounts from two (2%) to ten percent (10%) of his Compensation; or such greater percentage of Compensation as the Board, in its sole discretion, determines and communicates to eligible Employees prior to the commencement of the first Offering Period affected thereby. The aggregate of such payroll deductions during any Offering Period shall not exceed ten percent (10%) of his aggregate Compensation (or such greater percentage of Compensation as is determined by the Board pursuant to the preceding sentence) during said offering period.

6.2 All payroll deductions made by a participant shall be credited to his account under the Plan. A participant may not make any additional payments into such account.

6.3 A participant may discontinue his participation in the Plan as provided in paragraph 11, or may decrease or increase the rate or amount of his payroll deductions during the Offering Period (within the limitations of paragraph 6(a)) by completing and filing with the Company a new subscription agreement authorizing a change in the rate or amount of payroll deductions; provided, however, that a participant may not change the rate or amount of his payroll deductions more than two (2) times in any one calendar year. The change in rate shall be effective fifteen (15) days following the Company's receipt of the new authorization. Subject to the limitations of paragraph 6(a), a participant's subscription agreement shall remain in effect for successive Offering Periods unless revised as provided herein or terminated as provided in paragraph 11.

6.4 Notwithstanding the foregoing, to the extent necessary to comply with Section 423(b)(8) of the Code and paragraph 3(b) herein, a participant's payroll deductions may be decreased to 0% at such time during any Exercise Period which is scheduled to end during the current calendar year that the

aggregate of all payroll deductions accumulated with respect to such Exercise Period and any other Exercise Period ending within the same calendar year equal \$21,250. Payroll deductions shall recommence at the rate provided in such participant's subscription agreement at the beginning of the first Exercise Period which is scheduled to end in the following calendar year, unless terminated by the participant as provided in paragraph 11.

## 7. GRANT OF OPTION.

- 7.1 On the Offering Date of each Offering Period, each eligible Employee participating in such Offering Period shall be granted an option to purchase on each Exercise Date during such Offering Period a number of shares of the Company's Common Stock determined by dividing such Employee's payroll deductions accumulated prior to such Exercise Date and retained in the Participant's account as of the Exercise Date by the lower of (i) eighty-five percent (85%) of the fair market value of a share of the Company's Common Stock on the Offering Date or (ii) eighty-five percent (85%) of the fair market value of a share of the Company's Common Stock on the Exercise Date; provided, however, that the maximum number of Shares an Employee may purchase during each Offering Period shall be determined at the Offering Date by dividing \$25,000 by the fair market value of a share of the Company's Common Stock on the Offering Date, and provided further that such purchase shall be subject to the limitations set forth in paragraphs 3.4 and 13 hereof. In the case of the Non-423 Component, the number of shares shall be determined as set forth in the preceding sentence or determined pursuant to such manner or method as determined by the Administrator to comply with non-U.S. requirements. Exercise of the option shall occur as provided in paragraph 8, unless the participant has withdrawn pursuant to paragraph 11, and shall expire on the last day of the Offering Period. Fair market value of a share of the Company's Common Stock shall be determined as provided in paragraph 7(b) herein.
- 7.2 The option price per share of the shares offered in a given Exercise Period shall be the lower of: (i) eighty-five percent (85%) of the fair market value of a share of the Common Stock of the Company on the Offering Date; or (ii) eighty-five percent (85%) of the fair market value of a share of the Common Stock of the Company on the Exercise Date, and in the case of the Non-423 Component, it shall be the lower of prices above or determined pursuant to such manner or method as determined by the Administrator to comply with non-U.S. requirements. The fair market value of the Company's Common Stock on a given date shall be determined by the Board in its discretion; provided, however, that where there is a public market for the Common Stock, the fair market value per share shall be the closing price of the Common Stock for such date on the NASDAQ or on such other stock exchange as the Company's Common Stock may be traded or, if not traded on a stock exchange, as reported by the NASDAQ National Market System, or, in the event the Common Stock is not listed on a stock exchange or NASDAQ's National Market System, the fair market value per share shall be the mean of the bid and asked prices of the Common Stock reported for such date in over-the-counter trading.
8. EXERCISE OF OPTION. Unless a participant withdraws from the plan as provided in paragraph 11, his option for the purchase of shares will be exercised automatically on each exercise date of the offering period, and the maximum number of full shares subject to option shall be purchased for such participant at the applicable option price with the accumulated payroll deductions in his account. During a participant's lifetime, a participant's option to purchase shares hereunder is exercisable only by him.
9. DELIVERY. As promptly as practicable after the exercise date of each exercise period, the Company shall arrange the delivery to each participant, as appropriate, of a certificate representing the shares purchased upon exercise of his option or an electronic notice reflecting the allocation of such shares to his brokerage account. Any cash remaining to the credit of a participant's account under the plan after a purchase by him of shares at the termination of each exercise period which is insufficient to purchase a full share of common stock of the Company shall be applied to the participant's account for the next exercise period. Any other excess accumulated payroll deductions shall be returned to the participant.

- 10. AUTOMATIC TRANSFER TO LOW PRICE OFFERING PERIOD.** In the event that the fair market value of the Company's common stock is lower on an Exercise Date than it was on the Offering Date for that Offering Period, all employees participating in the plan on the Exercise Date shall be deemed to have withdrawn from the Offering Period immediately after the exercise of their option on such Exercise Date and to have enrolled as participants in the newly commencing Offering Period. A participant may elect to remain in the previous Offering Period by filing a written statement declaring such election with the Company prior to the time of the automatic change to the new Offering Period.
- 11. WITHDRAWAL; TERMINATION OF EMPLOYMENT.**
- 11.1 A participant may withdraw all but not less than all the payroll deductions credited to his account and not yet used to exercise his option under the Plan at any time by giving written notice to the Company. Notwithstanding the foregoing, for purposes of Employees participating in the Code Section 423 Plan Component, the processing of withdrawals, whether on-line or via hard copy, will be applied in a uniform and non-discriminatory basis. All of the participant's payroll deductions credited to his account will be paid to such participant promptly after receipt of notice of withdrawal and such participant's option for the Offering Period will be automatically terminated, and no further payroll deductions for the purchase of shares will be made during the Offering Period. If a participant withdraws from an Offering Period, payroll deductions will not resume at the beginning of the succeeding Offering Period unless the participant delivers to the Company a new subscription agreement.
- 11.2 Upon termination of the participant's Continuous Status as an Employee prior to an Exercise Date for any reason, including retirement or death, the payroll deductions credited to such participant's account during the Offering Period but not yet used to exercise the option will be returned to such participant or, in the case of his death, to the person or persons entitled thereto under paragraph 15, and such participant's option will be automatically terminated.
- 11.3 In the event an Employee fails to remain in Continuous Status as an Employee of the Company during an Offering Period in which the Employee is a participant, he will be deemed to have elected to withdraw from the Plan and the payroll deductions credited to his account will be returned to such participant and such participant's option terminated.
- 11.4 A participant's withdrawal from an Offering Period will not have any effect upon his eligibility to participate in any similar plan which may hereafter be adopted by the Company or in succeeding Offering Periods which commence after the termination of the Offering Period from which the participant withdraws.
- 11.5 A participant's withdrawal from an Offering Period will not have any effect upon his or her eligibility to participate in any similar plan which may hereafter be adopted by the Company.
- 12. INTEREST.** No interest shall accrue on the payroll deductions of a participant in the Plan, except as may be required by applicable law, as determined by the Administrator, for participants in the Non-423 Plan Component (or the Code Section 423 Plan Component if permitted under Section 423 of the Code).
- 13. STOCK.**
- 13.1 The maximum number of shares of the Company's Common Stock which are available for future issuance under the Plan shall be 4,210,080 shares, plus, commencing on the first day of the Company's 2014 fiscal year, an annual increase equal to the lesser of (i) 2,000,000 shares, (ii) .75% of the Issued Shares (as defined below) as of the last day of the immediately preceding fiscal year, or (iii) a lesser amount determined by the Board, all subject to adjustment upon changes in capitalization of the Company as provided in paragraph 19. "Issued Shares" shall mean the number of shares of Common Stock of the Company outstanding on such date plus any shares reacquired by the Company during the fiscal year that ends on such date. If the total number of shares which would otherwise be subject to options granted pursuant to paragraph 7(a) hereof on the Exercise Date exceeds the number of shares then available under the Plan (after deduction of all shares for which

- options have been exercised or are then outstanding), the Company shall make a pro rata allocation of the shares remaining available for option grant in as uniform a manner as shall be practicable and as it shall determine to be equitable; provided, however, for purposes of Employees participating in the Code Section 423 Plan Component, any pro rata allocation, will be applied on a uniform and non-discriminatory basis. In such event, the Company shall give written notice of such reduction of the number of shares subject to the option to each Employee affected thereby and shall similarly reduce the rate of payroll deductions, if necessary.
- 13.2 The participant will have no interest or voting right in shares covered by his option until such option has been exercised.
- 13.3 Shares to be delivered to a participant under the Plan will be registered in the name of the participant or in the name of the participant and his spouse.
- 14. ADMINISTRATION.** The Plan shall be administered by the Administrator. The Administrator is specifically authorized to adopt rules, procedures and subplans, which for purposes of the Non-423 Component may be outside the scope of Section 423 of the Code, regarding, but not limited to, eligibility to participate, the definition of Compensation, handling of payroll deductions, making of contributions to the Plan (including, without limitation, in forms other than payroll deductions), establishment of bank or trust accounts to hold payroll deductions, payment of interest, conversion of local currency, obligations to pay payroll tax, determination of beneficiary designation requirements, withholding procedures and handling of stock certificates which vary with local requirements. The administration, interpretation or application of the Plan by the Administrator shall be final, conclusive and binding upon all participants.
- 15. DESIGNATION OF BENEFICIARY.**
- 15.1 A participant may file a written designation of a beneficiary who is to receive any shares and cash, if any, from the participant's account under the Plan in the event of such participant's death subsequent to the end of the Offering Period but prior to delivery to him of such shares and cash. In addition, a participant may file a written designation of a beneficiary who is to receive any cash from the participant's account under the Plan in the event of such participant's death prior to the Exercise Date of the Offering Period.
- 15.2 Such designation of beneficiary may be changed by the participant at any time by written notice. In the event of the death of a participant and in the absence of a beneficiary validly designated under the Plan who is living at the time of such participant's death, the Company shall deliver such shares and/or cash to the executor or administrator of the estate of the participant, or if no such executor or administrator has been appointed (to the knowledge of the Company), the Company, in its discretion, may deliver such shares and/or cash to the spouse or to any one or more dependents or relatives of the participant, or if no spouse, dependent or relative is known to the Company, then to such other person as the Company may designate.
- 16. TRANSFERABILITY.** Neither payroll deductions credited to a participant's account nor any rights with regard to the exercise of an option or to receive shares under the plan may be assigned, transferred, pledged or otherwise disposed of in any way (other than by will, the laws of descent and distribution or as provided in paragraph 15 hereof) by the participant. Any such attempt at assignment, transfer, pledge or other disposition shall be without effect, except that the Company may treat such act as an election to withdraw funds in accordance with paragraph 11.
- 17. USE OF FUNDS.** All payroll deductions received or held by the Company under the plan may be used by the Company for any corporate purpose, and the Company shall not be obligated to segregate such payroll deductions except for deductions or contributions made to a Non-423 Component where, as determined by the Administrator, non-U.S. law requires segregation of such amounts. Until shares are issued, participants shall only have the rights of an unsecured creditor, although participants in the Non-423 Component may have additional rights where required under local law, as determined by the Administrator.

- 18. REPORTS.** Individual accounts will be maintained for each participant in the plan. Statements of account will be given to participating employees promptly following the exercise date, which statements will set forth the amounts of payroll deductions, the per share purchase price, the number of shares purchased and the remaining cash balance, if any.
- 19. ADJUSTMENTS UPON CHANGES IN CAPITALIZATION.** Subject to any required action by the stockholders of the Company, the number of shares of common stock covered by each option under the plan which has not yet been exercised and the number of shares of common stock which have been authorized for issuance under the plan but have not yet been placed under option, including the annual share replenishment limit of two million shares set forth in Section 13, (collectively, the “reserves”) as well as the price per share of common stock covered by each option under the plan which has not yet been exercised, shall be proportionately adjusted for any increase or decrease in the number of issued shares of common stock resulting from a stock split or the payment of a stock dividend (but only on the common stock) or any other increase or decrease in the number of shares of common stock effected without receipt of consideration by the Company; provided, however, that conversion of any convertible securities of the Company shall not be deemed to have been “effected without receipt of consideration”. Such adjustment shall be made by the Board, whose determination in that respect shall be final, binding and conclusive. Except as expressly provided herein, no issue by the Company of shares of stock of any class, or securities convertible into shares of stock of any class, shall affect, and no adjustment by reason thereof shall be made with respect to, the number or price of shares of common stock subject to an option.

In the event of the proposed dissolution or liquidation of the Company, the offering period will terminate immediately prior to the consummation of such proposed action, unless otherwise provided by the Board. In the event of a proposed sale of all or substantially all of the assets of the Company, or the merger of the Company with or into another corporation, each option under the Plan shall be assumed or an equivalent option shall be substituted by such successor corporation or a parent or subsidiary of such successor corporation, unless the Board determines, in the exercise of its sole discretion and in lieu of such assumption or substitution, that the participant shall have the right to exercise the option as to all of the option stock, including shares as to which the option would not otherwise be exercisable. If the Board makes an option fully exercisable in lieu of assumption or substitution in the event of a merger or sale of assets, the Board shall notify the participant that the option shall be fully exercisable for a period of thirty (30) days from the date of such notice, and the option will terminate upon the expiration of such period.

The Board may, if it so determines in the exercise of its sole discretion, also make provision for adjusting the Reserves, as well as the price per share of Common Stock covered by each outstanding option, in the event that the Company effects one or more reorganizations, recapitalizations, rights offerings or other increases or reductions of shares of its outstanding Common Stock, and in the event of the Company being consolidated with or merged into any other corporation.

**20. AMENDMENT OR TERMINATION.**

- 20.1 The Administrator may at any time and for any reason terminate or amend the Plan. Except as otherwise provided in the Plan, no such termination can affect options previously granted, provided that an Offering Period may be terminated by the Administrator on any Exercise Date if the Administrator determines that the termination of the Offering Period or the Plan is in the best interests of the Company and its stockholders. Except as provided in Section 19 and this Section 20 hereof, no amendment may make any change in any option theretofore granted which adversely affects the rights of any participant. To the extent necessary to comply with Section 423 of the Code (or any successor rule or provision or any other applicable law, regulation or stock exchange rule), the Company shall obtain stockholder approval in such a manner and to such a degree as required.
- 20.2 Without stockholder consent and without regard to whether any participant rights may be considered to have been “adversely affected,” the Administrator shall be entitled to change the Offering Periods, limit the frequency and/or number of changes in the amount withheld during an Offering Period, establish the exchange ratio applicable to amounts withheld in a currency other than U.S. dollars,

permit payroll withholding in excess of the amount designated by a participant in order to adjust for delays or mistakes in the Company's processing of properly completed withholding elections, establish reasonable waiting and adjustment periods and/or accounting and crediting procedures to ensure that amounts applied toward the purchase of Common Stock for each participant properly correspond with amounts withheld from the participant's Compensation, and establish such other limitations or procedures as the Administrator determines in its sole discretion advisable which are consistent with the Plan.

- 20.3 In the event the Administrator determines that the ongoing operation of the Plan may result in unfavorable financial accounting consequences, the Administrator may, in its discretion and, to the extent necessary or desirable, modify or amend the Plan to reduce or eliminate such accounting consequence including, but not limited to:
- 20.3.1 increasing the Purchase Price for any Offering Period including an Offering Period underway at the time of the change in Purchase Price;
  - 20.3.2 shortening any Offering Period so that Offering Period ends on a new Exercise Date, including an Offering Period underway at the time of the Administrator action; and
  - 20.3.3 allocating shares.
- 21. NOTICES.** All notices or other communications by a participant to the Company under or in connection with the plan shall be deemed to have been duly given when received in the form specified by the Company at the location, or by the person, designated by the Company for the receipt thereof.
- 22. CONDITIONS UPON ISSUANCE OF SHARES.** Shares shall not be issued with respect to an option unless the exercise of such option and the issuance and delivery of such shares pursuant thereto shall comply with all applicable provisions of law, domestic or foreign, including, without limitation, the securities act of 1933, as amended, the act, the rules and regulations promulgated thereunder, and the requirements of any stock exchange upon which the shares may then be listed, and shall be further subject to the approval of counsel for the Company with respect to such compliance.
- As a condition to the exercise of an option, the Company may require the person exercising such option to represent and warrant at the time of any such exercise that the shares are being purchased only for investment and without any present intention to sell or distribute such shares if, in the opinion of counsel for the Company, such a representation is required by any of the aforementioned applicable provisions of law.
- 23. CODE SECTION 409A.** The Code Section 423 Plan Component is exempt from the application of Code Section 409A. The Non-423 Plan Component is intended to be exempt from Code Section 409A under the short-term deferral exception and any ambiguities herein will be interpreted to so be exempt from Code Section 409A. In furtherance of the foregoing and notwithstanding any provision in the Plan to the contrary, if the Administrator determines that an option granted under the Plan may be subject to Code Section 409A or that any provision in the Plan would cause an option under the Plan to be subject to Code Section 409A, the Administrator may amend the terms of the Plan and/or of an outstanding option granted under the Plan, or take such other action the Administrator determines is necessary or appropriate, in each case, without the participant's consent, to exempt any outstanding option or future option that may be granted under the Plan from or to allow any such options to comply with Code Section 409A, but only to the extent any such amendments or action by the Administrator would not violate Code Section 409A. Notwithstanding the foregoing, the Company shall have no liability to a participant or any other party if the option to purchase Common Stock under the Plan that is intended to be exempt from or compliant with Code Section 409A is not so exempt or compliant or for any action taken by the Administrator with respect thereto. The Company makes no representation that the option to purchase Common Stock under the Plan is compliant with Code Section 409A.
- 24. TERM OF PLAN.** Except to the extent it is terminated earlier pursuant to Section 20, the plan shall remain in effect until May 10, 2023.



THIS PAGE INTENTIONALLY LEFT BLANK

THIS PAGE INTENTIONALLY LEFT BLANK

THIS PAGE INTENTIONALLY LEFT BLANK

THIS PAGE INTENTIONALLY LEFT BLANK

## FX3: CYPRESS'S USB 3.0 SOLUTION FOR AMAZING SUPERSPEED APPLICATIONS

The 5-Gbps USB 3.0 standard has become the system interface of choice for high-definition video applications, including machine vision, and medical and industrial cameras, without image-degrading video compression. Cypress is the USB leader, having shipped *more than 1.2 billion* units to date. Our one-chip USB 3.0 solution, EZ-USB® FX3™—like the FX2™ and FX1™ before it—is the industry's de facto peripheral controller. FX3 powers the world's most advanced HD video cameras.

Leap Motion selected FX3 to drive its 3-D motion controller, which enables users to execute sophisticated 3-D gestures by taking stereo pictures of the hand. Leap Motion is able to track hand and finger movements to 1/100th of a millimeter—100 times more sensitive than the best existing motion control systems.

### USB 3.0 ENABLES PERFECT HD IMAGES AND ACCURATE 3-D MOTION CONTROL

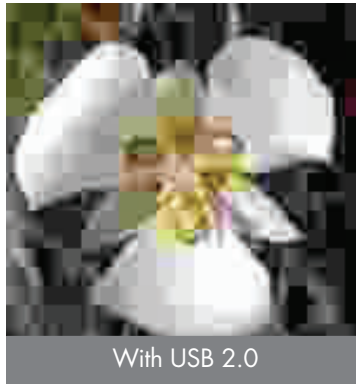

With USB 2.0

Compressed USB 2.0 video degrades image quality.



With USB 3.0

Uncompressed USB 3.0 video delivers the high-resolution image quality today's consumers demand.



The 5.0 Gbps performance of USB 3.0 enables 3-D gestures in motion-control systems for PCs.

## CYPRESS NVRAM PRODUCTS: THE FASTEST, DENSEST, AND LOWEST-POWER

What do you do when you are storing critical data in a memory and the power goes out? Nonvolatile RAMs (NVRAMs) retain data when power is lost without the need for battery backup. They also provide the functionality and speed of traditional SRAMs.

Three key investments enabled Cypress to attain leadership in the NVRAM market. First, we have continued investing in our existing SONOS technology to improve our nonvolatile SRAM (nvSRAM), which has long been the world's **fastest** NVRAM. Second, we have invested in our internal startup, AgigA Tech—part of our Emerging Technology Division—enabling it to produce AGIGARAM®, the world's **highest-density** NVRAM (up to 8 GBytes). Third, we have acquired Ramtron International Corp. for its ferroelectric random access memory (F-RAM) technology, the world's **lowest-power** NVRAM technology.

### nvSRAM THE FASTEST NVRAM



nvSRAM is the fastest NVRAM on the market, equivalent to classic high-speed SRAM. In network equipment, nvSRAM is used to save critical diagnostic data when there is a power outage.

### AGIGARAM® THE HIGHEST-DENSITY NVRAM



AGIGARAM is a new class of NVRAM for enterprise server and storage systems that provides the speed and density (up to 8 GBytes) of DRAM. It is also up to 1,000x faster than flash memory it replaces.

### F-RAM THE LOWEST-POWER NVRAM



F-RAM retains the power measurement data needed for smart meters. It consumes as little as 1/100th the power and is up to 2,000x faster than the traditional EEPROM memory it replaces.

# CYPRESS TOUCH-SENSING SOLUTIONS: A SUPERIOR USER EXPERIENCE

Consumers are demanding elegant, sophisticated user interfaces for their home appliances, automobiles, smartphones, tablets and consumer electronics. Cypress is the No. 1 provider of capacitive touch sensing products, including our TrueTouch® and CapSense® solutions. We have shipped *more than one billion* capacitive touch units. Our sensing technology can be found in automobiles from Tesla to Toyota, nine of the Top 10 mobile phone suppliers, and a wide range of consumer electronics.

Our newest product, the Gen5 TrueTouch controller, features patented analog sensing technology that delivers flawless touch performance in the face of electronic “noise” from chargers and displays. This allows customers to create thinner mobile devices that work with any charger. Gen5 also delivers the industry’s best waterproofing, along with user-friendly functionality such as activating by sensing an approaching finger and tracking touches when the user is wearing a glove.

## CYPRESS AUTOMOTIVE TOUCH SOLUTIONS



Tesla’s design team wanted to differentiate the interior of the revolutionary Model S—the world’s first premium-class electrically powered sedan...



TESLA

So it selected Cypress’s TrueTouch solution to drive the 17-inch touchscreen in the dashboard’s center stack—the largest in any vehicle to date and the first to integrate all functional controls. Tesla describes the display as the “gem” of its interior design.



TOYOTA

Toyota and its system supplier DENSO demand quality and reliability...

So they turned to Cypress’s TrueTouch and CapSense controllers for the capacitive touchscreen, buttons and sliders in the 2013 Toyota Avalon.

## HIGH-PERFORMANCE SOLUTIONS



Cypress capacitive touch solutions offer industry-leading noise immunity for flawless finger tracking in consumer electronic products such as the Kindle Fire HD and security keypads such as the one on this Samsung EZON digital door lock.



TrueTouch and CapSense controllers feature the world’s best waterproofing technology, bringing durability to touch controls in home appliances such as the Saeco Espresso Machine and smartphones such as the new Samsung Galaxy Grand DUOS.



Cypress Semiconductor Corporation 198 Champion Court, San Jose, CA 95134-1709  
(408) 943-2600 [www.cypress.com](http://www.cypress.com)